



# **URB Group**

## **Rolling Bearings**

### **General Catalogue**

## **URB Group Companies**

### **RULMENTI SA Barlad**

320 Republicii street , zip code 731130, Barlad ROMANIA

Tel.: +40 235 411 120

Fax: +36 23 382 822

### **Anadolu Rulman Imalat Sanayi ve Ticaret A.Ş.**

Yaka Mah. 401. Sok. No:17 CUMAYERI/DUZCE TURKEY

Tel.: +90 380 735 51 54

Fax: +90 380 735 51 77

### **New MGM Zrt.**

Gyar u. 2, H 2049 Diosd HUNGARY

Tel: +36 23 546 300

Fax: +36 23 382 822

### **URB India Bearing Factory & Trade Pvt ltd**

Unit No. 925-926, 9th floor, JMD Megapolis, Sector- 48

Sohna Road Gurgaon -122018 (Haryana)

*This catalogue v.15\_2019 or parts there of may not be reproduced without URB GROUP permission.*

*Every care has been taken to ensure the correctness of this catalogue informational content, but no liability can be accepted for any errors or omissions.*





*The wise choice for*  
**U**ltra **R**eliable **B**earings

# **URB Group Rolling Bearings General Catalogue**

Selection of bearing type	page 8					
Selection of bearing size	page 12					
Bearing tolerances	page 25					
Bearing applications	page 43					
Bearing lubrication	page 62					
Bearing designation	page 70					
Mounting and dismounting	page 72					
Deep groove ball bearings	page 81	618 619 160 161	60 622 623 63 64			
Self-aligning ball bearings	page 117	12 13	22 23			
Angular contact ball bearings	page 133	72B 73B 70C	72A 72C 72A			
Cylindrical roller bearings single row double row full complement	page 153	28 19 29 10 20	22 3 23 4			
Tapered roller bearings single row	page 287	329 320 302 322	303 313 323			
Spherical roller bearings	page 313	239 230 240 231 241	222 232 213 223			
Thrust ball bearings single direction double direction	page 441	511 512 513 514			522 523 524	
Cylindrical roller thrust bearings	page 485	811 812 851 852			522 523 524	
Support rollers	page 501					
Rolling Elements	page 509					
Accessories Adapter Sleeves Withdrawal Sleeves	page 527	H2 H22 H3 H23	H30 H31 H32			





2Z



2RS



K



N



NR

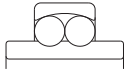

112;113

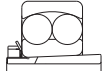

K + H

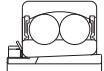

K2RSR + H



BDF



CTA  
ATA



CTB  
ATB



CTBDT  
ATBDT



CTBDB  
ATBDB



CTBDF  
ATBDF



N



NJ+HJ



NU+HJ



NCF...V



NJ...VH

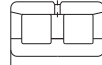

NN30

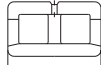

NNU49



MBK



CK



MBK+H



CK+H



MBK+AH

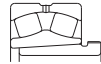

CK+AH

- AH30 AH3
- AH31 AH23
- AH2 AH240
- AH22 AH241
- AH32



## Measuring units of the international system SI

### Lenght

1 mm = 0,039 in

1 in = 25,4 mm

### Mass

1 kg = 2,205 lb

### Force

1 kN = 1 000 N = 225 lbf

1 kgf = 9,81 N

1 lbf = 4,45 N

### Moment

1 N mm = 0,102 kgf mm

1 kgf mm = 9,81 N mm

1 N m = 8,85 in lbf

1 in lbf = 0,113 N mm

### Pressure per unit of area (surface)

1 N/mm<sup>2</sup> = 1 MPa = 145 psi

1 psi = 0,102 kgf/mm<sup>2</sup>

1 kgf/mm<sup>2</sup> = 9,81 N/mm<sup>2</sup>

### Power

1 W = 1 J/s = 1 N m/s = 0,102 kgf m/s

1 kW = 1,36 CP = 102 kgf m/s

1 kgf m/s = 9,81 N m/s = 9,81 j/s

### Mechanical work

1 kgf m = 9,81 W s = 9,81 N m

1 J (Joule) = 1 N m = 1 W s = 0,102 kgf m

### Kinematic viscosity

1 mm<sup>2</sup>/s = 1 cSt (centiStokes)

# URB GROUP

URB-ROMANIA ART-TURKEY MGM-HUNGARY

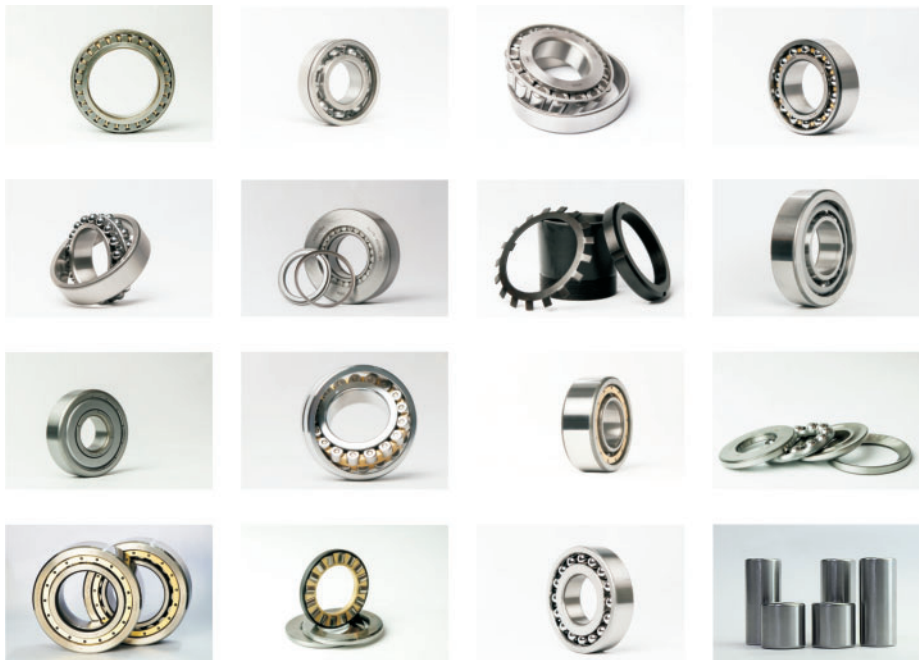



# Selection of bearing type

Each type of bearing displays characteristics features which make it suitable for a certain application. Therefore, many bearings types and constructive versions have been developed so that they can satisfy various demands for rolling bearings. No general rule can be given, taking into account the great number of factors to be considered when selecting a bearing type.

We give further the most important criteria to be considered when selecting the bearing type.

## Selection of bearing type, considering the load magnitude and direction

### Radial load

Deep groove ball bearings are the most suitable types of bearings for light and moderate pure radial loads. For heavy radial load and where large-diameter shafts are used, double row cylindrical roller bearings are the adequate choice.

### Axial load

For pure axial loads, single direction thrust ball bearings are used in case of loads acting in one directions. For loads acting in both directions, double direction thrust ball bearings are used. Angular contact thrust ball bearing and single or double row angular contact ball bearings, are used in case of light or moderate pure axial loads at moderate speeds.

For light axial loads at high speeds, deep groove ball bearings are suitable. Under the axial load, a contact angle different from  $0^\circ$  is generated in these bearings and therefore they operate as angular contact ball bearings.

In order to increase axial load carrying capacity, a larger clearance should be selected (C3, C4). For moderate axial loads at high speed, angular contact

ball bearings in tandem arrangement are used so that they can take over loads acting in both directions.

### Combined load

In order to carry combined radial and axial loads acting simultaneously, bearings with a contact angle different from  $0^\circ$  are used. The greater the contact angle, the greater the axial load carrying capacity.

Self-aligning ball bearings, spherical roller bearings or cylindrical roller bearings (NJ, NUP, NJ + HJ types), can also accommodate combined loads of certain values. But there are some limit values of the ratio  $F_a/F_r$ , which are shown in bearing tables and cannot be exceeded. Cylindrical roller bearings can carry axial loads by means of the sliding friction on ribs. For this reason, the load is limited according to the indications on pages 158, 159.

Bearings which accommodate only one direction axial loads should always be mounted in pairs so that they can carry axial loads in both directions.

## Selection of bearing type considering the alignment between shaft and housing

Angular misalignments occur generally when the shaft bends under the operating load or when bearings joint parts have deviations of form or position.

In such cases, self-aligning ball bearings, spherical roller bearings or spherical roller thrust bearings should be used.

A certain bearing bending angle which can compensate for errors of alignment and maximum angle values are shown for each type in the introductory texts of the table sections.

When misalignments should be compensated, radial and axial clearance are important. The larger the clearance, the greater the possibility of self-aligning.

If the misalignment exceeds the permissible values shown in the introductory texts of the bearing tables, the bearing rating life decreases. The greater the ratio  $Fr/C_{or}$ , the shorter the rating life. If  $0,1 < Fr/C_{or} < 3$ , the rating life decreases with about 25%.

## Selection of bearing type considering the operating temperature

Bearings are generally used up to a temperature of maximum  $+120^{\circ}\text{C}$ . In case of higher temperatures, bearings with special heat treatments should be used, in accordance with specifications on page 23. Sealed bearings, 2RS type, should be used at operating temperatures up to  $80^{\circ}\text{C}$ . If this temperature is exceeded, the efficiency of lubricants is considerably reduced.

## Selection of bearing internal clearance

In most cases, while operating, bearings should have a small radial clearance that can be defined as "the possible value of displacement in radial direction of one bearing ring in relation to the other without parts deformations".

While operating, bearing internal clearance is different from the one at delivery, since the latter is reduced when mounting bearings with a certain tight fit.

Under operating conditions, internal clearance change is also caused by different temperatures between the outer and inner ring. Bearings are generally delivered with a normal radial or axial clearance according to the values shown for each rolling bearing group.

The decrease in radial clearance due to the tight fit and operating temperature is considered to be between 60-80% of the tightening value, depending on bearing series and size.

After the clearance in bearings has been decreased, a large enough operational clearance should remain, so that the lubricant film shouldn't be destroyed.

Deep groove ball bearings should have an operational clearance close to zero. There may be often a light preload, due to the point-contact between the rolling elements and raceways.

Small-sized cylindrical roller bearings should have an operational clearance of  $5\text{-}10\ \mu\text{m}$  and larger-sized bearings a clearance of  $10\text{-}30\ \mu\text{m}$ .

Bearings can also be manufactured - at request - with radial and axial clearance smaller (C1 and C2) or larger (C3, C4 and C5) than normal, so that the most favorable operating conditions for bearings should be assured.

Cylindrical roller bearings can be manufactured with non-interchangeable rings (suffix NA).

Bearings with non-interchangeable parts have a different radial clearance than bearings with interchangeable parts. Changing rings from one bearing to another is not allowed.

In case of bearings with interchangeable parts, rings may be changed and the values of radial clearance will not be altered.

## Bearing types and technical characteristics

URB bearings can be manufactured in various type and size, so that they can meet the customers' requirements assuring a proper reliability for various applications.

Table 1.1 shows suitability of each group of bearings, considering the main technical characteristics.

Bearing type is selected depending on the technical characteristics required by a certain application.

A suggestive graphic symbol has been determined for each main technical characteristic. Thus, a proper bearing for each purpose can be easily chosen. According to the specifications in this catalogue, the proper type and size of bearing can be selected, together with all manufacturing and operating technical conditions.

## Bearing types and their characteristics







































































































































































































 - excellent  - poor  - good  - unsuitable  - fair  - single direction  - double direction		Purely radial load	Purely axial load	Combined load	Moment load
Deep groove ball bearings					
Self-aligning ball bearings					
Angular contact ball bearings - single row	 				
- high precision	 				
- double rows	 				
Cylindrical roller bearings - NU; N	 				
- NJ, NU+HJ, NUP, NJ+HJ	   				
- NCF, NJ23VH	 				
- NNU, NN	 				
Spherical roller bearings	 				
Tapered roller bearings - single row					
Thrust ball bearing - single direction - double direction	 				

Table 1.1

Tolerance class	Quiet running	High speed	High stiffness	Compensation of misalignment	Low friction	Shock resistance	Located bearing	Non-located bearing	Axial displacement possible in bearing
									
									
								 <sup>a</sup>	
								 <sup>a</sup>	
									
									
									
									
									
									
									
									



# Selection of bearing size

The size of a bearing is selected considering as usually factor magnitude of the load, and also selection depends on the operational rating life and prescribed operating safety.

## Basic load ratings

The basic dynamic load rating  $C_r$  is used to evaluate bearing dimensions while rotating under load. It expresses the bearing admissible load which will give a basic rating life up to 1000 000 revolutions.

The basic dynamic load ratings of URB bearings have been determined in accordance with international standard ISO 281. The values are given in bearing tables.

Considering the basic dynamic load rating, can be calculated the service time until the "metal fatigue" of rolling contact surfaces appears, determining this way the rating life.

The other characteristic, basic static load rating  $C_{or}$ , is considered in case of low speeds, low oscillating movements or in the stationary case.

The basic static load rating is defined in accordance with ISO 76, as the load acting upon the stationary bearing. It corresponds to a calculated contact stress in the center of the contact area between the most heavily loaded rolling element and the raceway, of:

- 4 600 MPa for self-aligning ball bearings,
- 4 200 MPa for all other ball bearings,
- 4 000 MPa for all roller bearings.

This stress produces a permanent deformations of the rolling element and raceway which is about 0,0001 of the rolling element diameter. The loads are pure radial for radial bearings and pure axial for thrust bearings.

## Bearing life

The life of a rolling bearing is defined as the number of revolutions or the number of operating hours, which the bearing is capable to endure, before

the first sign of metal fatigue occurs on one of its rings, on the raceway or the rolling elements.

If we want to consider only the fatigue of the bearing operating surfaces the following conditions have to be observed:

1. The forces and speeds considered when calculating the bearing should correspond to the real operating conditions.
2. Proper lubrication should be assured during the entire operating period.
3. If the bearing carries a light load, its failure is generated by wear.
4. Experience showed that the failure of many bearings was caused by other reasons than fatigue, such as: selection of an inadequate bearing type in a bearing assembly, improper operating conditions, lubrication contamination, etc.

## Basic rating life

The basic rating life of a single bearing or a group of apparently identical bearings operating under identical conditions, is the life corresponding to a reliability of 90%.

Basic rating life is marked with  $L_{10}$  (millions of revolutions) or  $L_{10h}$  (operating hours).

$L_{10}$  can be calculated using the equation:

$$L_{10} = \left( \frac{C}{P} \right)^p, \text{ where:}$$

$L_{10}$  - basic rating life, millions of revolutions,

$C$  - basic dynamic load rating, kN,

$P$  - equivalent dynamic bearing load, kN,

$p$  - exponent of the life equation

$p = 3$  - for ball bearings

$p = 10/3$  - for roller bearings

The equivalent dynamic bearing load, respectively the radial and axial load, acting simultaneously can be calculated using the following equations (applicable to ball and roller radial bearings):



$$P_r = F_r, \text{ kN,} \quad \text{- for pure radial load}$$

$$P_r = XF_r + YF_a, \text{ kN,} \quad \text{- for combined load}$$

For thrust ball bearings, the following equations can be used:

$$P_a = F_a, \text{ kN,} \quad \text{- for pure axial load}$$

$$P_a = XF_r + YF_a, \text{ kN,} \quad \text{- for combined load}$$

where:

$$F_r = \text{the radial component of the load, kN}$$

$$F_a = \text{the axial component of the load, kN}$$

In the texts preceding the bearing tables, for some groups of bearings there are given details for determining the equivalent load. Values of the coefficients X and Y can be found in tables.

For bearings operating at constant speed, the basic rating life expressed in operating hours can be calculated using the equation:

$$L_{10h} = \frac{1000000}{60n} \left(\frac{C}{P}\right)^p \quad \text{or} \quad L_{10h} = \frac{16666}{n} \left(\frac{C}{P}\right)^p$$

Where:

$$n = \text{rotational speed, r/min}$$

Values of the basic rating life  $L_{10}$  (millions of revolutions) as a function of the ratio C/P can be found in the table 2.1.

Values of the basic rating life  $L_{10h}$  (operating hours) as a function of the ratio C/P and speed n can be found in table 2.2 for ball bearings and table 2.3 for roller bearings.

When determining the bearing size it is necessary to base the calculations on the rating life corresponding to the purpose of operation.

Usually it depends on the machine type, service life and the requirements regarding operational safety.

Approximate values of the service life for various classes of machines and equipments for general purposes are given in table 2.4.

The basic rating life  $L_{10h}$  of the bearings can be determined as a function of service life, using the life

calculation chart on page 17.

The basic rating life of road and rail vehicle bearings, for axlebox bearings, is expressed as a function of the wheel diameter and covered distance (km), using the equation:

$$L_{10s} = \frac{\pi D}{1000} L_{10}$$

where:

$$L_{10} = \text{basic rating life, millions of revolutions}$$

$$L_{10s} = \text{service life distance, millions of kilometers}$$

$$D = \text{wheel diameter, metres}$$

Approximate values for the service life distance (kilometers covered), in case of light loaded cars and rail vehicles are given in table 2.5.



**Load ratio C/P for various life L10 (millions of revolutions)**

Table 2.1

L <sub>10</sub>	C/P		L <sub>10</sub>	C/P		L <sub>10</sub>	C/P	
	Ball bearings	Roller bearings		Ball bearings	Roller bearings		Ball bearings	Roller bearings
0,5	0,793	0,812	240	6,21	5,18	2000	12,6	9,78
0,75	0,909	0,917	260	6,38	5,3	2200	13	10,1
1	1	1	280	6,54	5,42	2400	13,4	10,3
1,5	1,14	1,13	300	6,69	5,54	2600	13,8	10,6
2	1,26	1,24	320	6,84	5,64	2800	14,1	10,8
3	1,44	1,39	340	6,98	5,75	3000	14,4	11
4	1,59	1,52	360	7,11	5,85	3200	14,7	11,3
5	1,71	1,62	380	7,24	5,94	3400	15	11,5
6	1,82	1,71	400	7,37	6,03	3600	15,3	11,7
8	2	1,87	420	7,49	6,12	3800	15,6	11,9
10	2,15	2	440	7,61	6,21	4000	15,9	12
12	2,29	2,11	460	7,72	6,29	4500	16,5	12,5
14	2,41	2,21	480	7,83	6,37	5000	17,1	12,9
16	2,52	2,3	500	7,94	6,45	5500	17,7	13,2
18	2,62	2,38	550	8,19	6,64	6000	18,2	13,6
20	2,71	2,46	600	8,43	6,81	6500	18,7	13,9
25	2,92	2,63	650	8,66	6,98	7000	19,1	14,2
30	3,11	2,77	700	8,88	7,14	7500	19,6	14,5
35	3,27	2,91	750	9,09	7,29	8000	20	14,8
40	3,42	3,02	800	9,28	7,43	8500	20,4	15,1
45	3,56	3,13	850	9,47	7,56	9000	20,8	15,4
50	3,68	3,23	900	9,65	7,7	9500	21,2	15,6
60	3,91	3,42	950	9,83	7,82	10000	21,5	15,8
70	4,12	3,58	1000	10	7,94	12000	22,9	16,7
80	4,31	3,72	1100	10,3	8,17	14000	24,1	17,5
90	4,48	3,86	1200	10,6	8,39	16000	25,2	18,2
100	4,64	3,98	1300	10,9	8,59	18000	26,2	18,9
120	4,93	4,2	1400	11,2	8,79	20000	27,1	1,5
140	5,19	4,4	1500	11,4	8,97	25000	29,2	20,9
160	5,43	4,58	1600	11,7	9,15	30000	31,1	22
180	5,65	4,75	1700	11,9	9,31			
200	5,85	4,9	1800	12,2	9,48			
220	6,04	5,04	1900	12,4	9,63			

**Ball bearings - load ratio C/P for various rating lives  $L_{10h}$  (operating hours) at different speed n (rpm)**

Table 2.2

$L_{10h}$	C/P when n =										
	50	100	150	200	250	300	400	500	750	1000	1500
100	0,67	0,84	0,97	1,06	1,14	1,22	1,34	1,44	1,65	1,82	2,08
500	1,14	1,44	1,65	1,82	1,96	2,08	2,29	2,47	2,82	3,11	3,56
1000	1,44	1,82	2,08	2,29	2,47	2,62	2,88	3,11	3,56	3,91	4,48
1250	1,55	1,96	2,24	2,47	2,66	2,82	3,11	3,35	3,83	4,22	4,83
1600	1,69	2,13	2,43	2,68	2,88	3,07	3,37	3,63	4,16	4,58	5,24
2000	1,82	2,29	2,62	2,88	3,11	3,30	3,63	3,91	4,48	4,93	5,65
2500	1,96	2,47	2,82	3,11	3,35	3,56	3,91	4,22	4,83	5,31	6,08
3200	2,13	2,68	3,07	3,37	3,63	3,86	4,25	4,58	5,24	5,77	6,60
4000	2,29	2,88	3,30	3,63	3,91	4,16	4,58	4,93	5,65	6,21	7,11
5000	2,47	3,11	3,56	3,91	4,22	4,48	4,93	5,31	6,08	6,69	7,66
6300	2,66	3,36	3,84	4,23	4,55	4,84	5,33	5,74	6,57	7,23	8,28
8000	2,88	3,63	4,16	4,58	4,93	5,24	5,77	6,21	7,11	7,83	8,96
10000	3,11	3,91	4,48	4,93	5,31	5,65	6,21	6,69	7,66	8,43	9,65
12500	3,35	4,22	4,83	5,31	5,27	6,08	6,69	7,21	8,25	9,09	10,4
16000	3,63	4,58	5,24	5,77	6,21	6,60	7,27	7,83	8,96	9,86	11,3
20000	3,91	4,93	5,65	6,21	6,69	7,11	7,83	8,43	9,65	10,6	12,2
25000	4,22	5,31	6,08	6,69	7,21	7,66	8,43	9,09	10,4	11,4	13,1
32000	4,58	5,77	6,60	7,27	7,83	8,32	9,16	9,86	11,3	12,4	14,2
40000	4,93	6,21	7,11	7,83	8,43	8,96	9,86	10,6	12,2	13,4	15,3
50000	5,31	6,69	7,66	8,43	9,09	9,65	10,6	11,4	13,1	14,4	16,5
63000	5,74	7,23	8,28	9,11	9,81	10,4	11,5	12,4	14,2	15,6	17,8
80000	6,21	7,83	8,96	9,86	10,6	11,3	12,4	13,4	15,3	16,9	19,3
100000	6,69	8,43	9,65	10,6	11,4	12,2	13,4	14,4	16,5	18,2	20,8
200000	8,43	10,6	12,2	13,4	14,4	15,3	16,9	18,2	20,8	22,9	26,2

$L_{10h}$	C/P when n =										
	2000	2500	3000	4000	5000	6000	8000	10000	15000	20000	30000
100	2,29	2,47	2,62	2,88	3,11	3,30	3,63	3,91	4,48	4,93	5,65
500	3,91	4,22	4,48	4,93	5,31	5,65	6,21	6,69	7,66	8,43	9,65
1000	4,93	5,31	5,65	6,21	6,69	7,11	7,83	8,43	9,65	10,6	12,2
1250	5,31	5,72	6,08	6,69	7,21	7,66	8,43	9,09	10,4	11,4	13,1
1600	5,77	6,21	6,60	7,27	7,83	8,32	9,16	9,86	11,3	12,4	14,2
2000	6,21	6,69	7,11	7,83	8,43	8,96	9,86	10,6	12,2	13,4	15,3
2500	6,69	7,21	7,66	8,43	9,09	9,65	10,6	11,4	13,1	14,4	16,5
3200	7,27	7,83	8,32	9,16	9,86	10,5	11,5	12,4	14,2	15,7	17,9
4000	7,83	8,43	8,96	9,86	10,6	11,3	12,4	13,4	15,3	16,9	19,3
5000	8,43	9,09	9,65	10,6	11,4	12,2	13,4	14,4	16,5	18,2	20,8
6300	9,11	9,81	10,4	11,5	12,4	13,1	14,5	15,6	17,8	19,6	22,5
8000	9,86	10,6	11,3	12,4	13,4	14,2	15,7	16,9	19,3	21,3	24,3
10000	10,6	11,4	12,2	13,4	14,4	15,3	16,9	18,2	20,8	22,9	26,2
12500	11,4	12,3	13,1	14,4	15,5	16,5	18,2	19,6	22,4	24,7	28,2
16000	12,4	13,4	14,2	15,7	16,9	17,9	19,7	21,3	24,3	26,8	30,7
20000	13,4	14,4	15,3	16,9	18,2	19,3	21,3	22,9	26,2	28,8	33,0
25000	14,4	15,5	16,5	18,2	19,6	20,8	22,9	24,7	28,2	31,1	35,6
32000	15,7	16,9	17,9	19,7	21,3	22,6	24,9	26,8	30,7	33,7	38,6
40000	16,9	18,2	19,3	21,3	22,9	24,3	26,8	28,8	33,0	36,3	41,6
50000	18,2	19,6	20,8	22,9	24,7	26,1	28,8	31,1	35,6	39,1	44,8
63000	19,6	21,1	22,5	24,7	26,6	28,3	31,2	33,6	38,4	42,3	48,4
80000	21,3	22,9	24,3	26,8	28,8	30,7	33,7	36,3	41,6	45,8	52,4
100000	22,9	24,7	26,2	28,8	31,1	33,0	36,3	39,1	44,8	49,3	56,5
200000	28,8	31,1	33,0	36,3	39,1	41,6	45,8	49,3	56,5	62,1	71,1



**Roller bearings - load ratio C/P for various basic rating lives  $L_{10h}$  (operating hours) at various speeds n (rpm)**

Table 2.3

$L_{10h}$	C/P when n=										
	50	100	150	200	250	300	400	500	750	1000	1500
100	0,70	0,86	0,97	1,06	1,13	1,19	1,30	1,39	1,57	1,71	1,93
500	1,13	1,39	1,57	1,71	1,83	1,93	2,11	2,25	5,24	2,77	3,13
1000	1,39	1,71	1,93	2,11	2,25	2,38	2,59	2,77	3,13	3,42	3,86
1250	1,49	1,83	2,07	2,25	2,41	2,54	2,77	2,97	3,35	3,65	4,12
1600	1,60	1,97	2,23	2,43	2,59	2,74	2,99	3,19	3,61	3,93	4,44
2000	1,71	2,11	2,38	2,59	2,77	2,93	3,19	3,42	3,86	4,20	4,75
2500	1,83	2,25	2,54	2,77	2,97	3,13	3,42	3,65	4,12	4,50	5,08
3200	1,97	2,43	2,74	2,99	3,19	3,37	3,68	3,93	4,44	4,84	5,47
4000	2,11	2,59	2,93	3,19	3,42	3,61	3,93	4,20	4,75	5,18	5,85
5000	2,25	2,77	3,13	3,42	3,65	3,86	4,20	4,50	5,08	5,54	6,25
6300	2,42	2,97	3,36	3,66	3,91	4,13	4,51	4,82	5,44	5,93	6,70
8000	2,59	3,19	3,61	3,93	4,20	4,44	4,84	5,18	5,85	6,37	7,20
10000	2,77	3,42	3,86	4,20	4,50	4,75	5,18	5,54	6,25	6,81	7,70
12500	2,97	3,65	4,12	4,50	4,81	5,08	5,54	5,92	6,68	7,29	8,23
16000	3,19	3,93	4,44	4,84	5,18	5,47	5,96	6,37	7,20	7,85	8,86
20000	3,42	4,20	4,75	5,18	5,54	5,85	6,37	6,81	7,70	8,39	9,48
25000	3,65	4,50	5,08	5,54	5,92	6,25	6,81	7,29	8,23	8,97	10,1
32000	3,93	4,84	5,47	5,96	6,37	6,73	7,34	7,85	8,86	9,66	10,9
40000	4,20	5,18	5,85	6,37	6,81	7,20	7,85	8,39	9,48	10,3	11,7
50000	4,50	5,54	6,25	6,81	7,29	7,70	8,39	8,97	10,1	11,0	12,5
63000	4,82	5,93	6,70	7,30	7,81	8,25	8,99	9,61	10,9	11,8	13,4
80000	5,18	6,37	7,20	7,85	8,39	8,86	9,66	10,3	11,7	12,7	14,4
100000	5,54	6,81	7,70	8,39	8,97	9,48	10,3	11,0	12,5	13,6	15,4
200000	6,81	8,39	9,48	10,3	11,0	11,7	12,7	13,6	15,4	16,7	18,9

$L_{10h}$	C/P when n =											
	2000	2500	3000	4000	5000	6000	8000	10000	15000	20000	30000	
100	2,11	2,25	2,38	2,59	2,77	2,93	3,19	3,42	3,86	4,20	4,75	
500	3,42	3,65	3,86	4,20	4,50	4,75	5,18	5,54	6,25	6,81	7,70	
1000	4,20	4,50	4,75	5,18	5,54	5,85	6,37	6,81	7,70	8,39	9,48	
1250	4,50	4,81	5,08	5,54	5,92	6,25	6,81	7,29	8,23	8,97	10,1	
1600	4,84	5,18	5,47	5,96	6,37	6,73	7,34	1,85	8,86	9,66	10,9	
2000	5,18	5,54	5,85	6,37	6,81	7,20	7,85	8,39	9,48	10,3	11,7	
2500	5,54	5,92	6,25	6,81	7,29	7,70	8,39	8,97	10,1	11,0	12,5	
3200	5,96	6,37	6,73	7,34	7,85	8,29	9,03	9,66	10,9	11,9	13,4	
4000	6,37	6,81	7,20	7,85	8,39	8,86	9,66	10,3	11,7	12,7	14,4	
5000	6,81	7,29	7,70	8,39	8,97	9,48	10,3	11,0	12,5	13,6	15,4	
6300	7,30	7,81	8,25	8,99	9,61	10,2	11,1	11,8	13,4	14,6	16,5	
8000	7,85	8,39	8,86	9,66	10,3	10,9	11,9	12,7	14,4	15,7	17,7	
10000	8,39	8,97	9,48	10,3	11,0	11,7	12,7	13,6	15,4	16,7	18,9	
12500	8,97	9,59	10,1	11,0	11,8	12,5	13,6	14,5	16,4	17,9	20,2	
16000	9,66	10,3	10,9	11,9	12,7	13,4	14,6	15,7	17,7	19,3	21,8	
20000	10,3	11,0	11,7	12,7	13,6	14,4	15,7	16,7	18,9	20,6	23,3	
25000	11,0	11,8	12,5	13,6	14,5	15,4	16,7	17,9	20,2	22,0	24,9	
32000	11,9	12,7	13,4	14,6	15,7	16,5	18,0	19,3	21,8	23,7	26,8	
40000	12,7	13,6	14,4	15,7	16,7	17,7	19,3	20,6	23,3	25,4	28,7	
50000	13,6	14,5	15,4	16,7	17,9	18,9	20,6	22,0	24,9	27,1	30,6	
63000	14,6	15,6	16,5	17,9	19,2	20,3	22,1	23,6	26,7	29,1	32,8	
80000	15,7	16,7	17,7	19,3	20,6	21,8	23,7	25,4	28,7	31,2	35,3	
100000	16,7	17,9	18,9	20,6	22,0	23,3	25,4	27,1	30,6	33,4	37,7	
200000	20,6	22,0	23,3	25,4	27,1	28,7	31,2	33,4	37,7	41,1	46,4	

### Basic rating life calculation chart

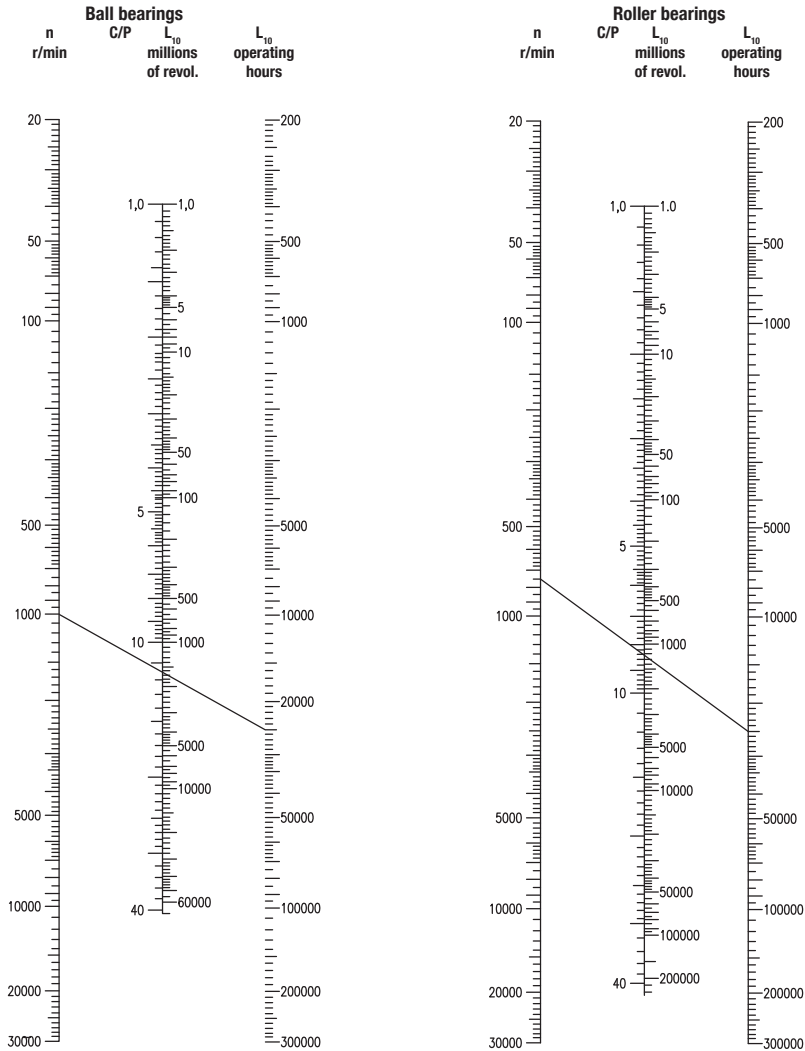

#### Example:

1. Determine the size of a deep groove ball bearing single row, considering the following conditions:

- Basic rating life  $L_{10h} = 25000$  operating hours
- Rotational speed  $n = 1000$  rpm
- Radial load  $F_r = P = 5$  kN

In the chart we find report:  $C/P = 11,6$ ;  $C = 11,6 \times P = 11,6 \times 5 = 58$  kN. In the catalogue on page 100, you can select bearing 6310 type, with the following characteristics:  $C_r = 61,8$  kN;  $n_{lim} = 7000$  rpm.

2. What is the basic life of the bearing NU 210E, operating under radial load of 7,7 kN, at a rotational speed  $n = 750$  rpm?

See page 172 in the catalogue and find for NU 210E type, the following values:  $C_r = 64,4$  kN,  $n_{lim} = 8000$  rpm. From the chart, for a roller bearing operated at 750 rpm, and  $C_r/P_r = 64,4/7,7 = 8,36$  result is a rating life  $L_{10h} = 25000$  hours.



**Recommended basic rating lives for general purpose machines**

Table 2.4

Application	Recommended basic rating life $L_{10h}$ (operating hours)
Household machines, technical apparatus for medical use, instruments, agricultural machines:	300..3000
Machines used for short periods or intermittently: electric hand tools, cranes, lifting tackles in workshops, building machines:	3000..8000
Machines used intermittently or for short periods with high operational reliability: lifts, small cranes	8000..12000
Machines for use 8 hours/day but not always at full capacity: machines for general purposes, electric motors for industrial use, rotary crushers, gear drives for general purposes:	10000..25000
Machines operating 8 hours/day at full capacity: machine tools, woodworking machines, large cranes, printing equipment, ventilators, separators, centrifuges:	20000..30000
Machines for continuous use 24 hours/day: Rolling mill gear units, medium sized electrical machinery, compressors, pumps, textile machines, mine hoists:	40000..50000
Hydraulic machines, rotary furnaces, capstans, propulsion machinery for sea vessel (propellers for sea vessels):	50000..100000
Machines for continuous use 24 hour/day with high reliability: large electric machinery, mine pumps and mine ventilators, power station plants, machines for cellulose industry, pumping units:	100000..

**Values for basic rating life  $L_{10s}$**

Table 2.5

Type of vehicle	$L_{10s} / 10^6$ [km]
Wheel hub bearings automotive:	
- light loaded cars	0,3
- trucks, buses	0,6
Axlebox bearings rail vehicles:	
- freight wagons (according to UIC)	0,8
- suburban vehicles, trams	1,5
- long distance passenger carriages	3
- motorailers	3...4
- Diesel and electric locomotives	3...4

In case of bearings which do not rotate, but oscillates from a central position through an angle, as shown in fig. 1, basic rating life can be determined as follows:

$$L_{10osc} = \frac{180}{2\gamma} L_{10}$$

Where:

$L_{10osc}$  = basic rating life, millions of cycles

$\gamma$  = oscillation amplitude (angle of maximum deviation from centre position), degrees

If oscillation of amplitude is very small, it can be ignored for basic dynamic rating life calculation. It will be only a static evaluation.

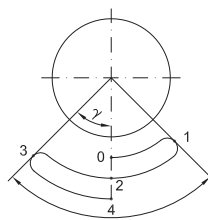

Fig. 1

**Fluctuating dynamic load and speeds**

In many cases, operation speed and magnitude of the load fluctuates. Therefore a mean dynamic load is to be calculated.

Complete oscillation =  $4\gamma$  from point 0 to point 4. The load acting on the bearing can vary as shown in fig. 2-a and 2-b.

In this case, the mean load can be determined using the equation:

$$F_m = \sqrt[n]{\frac{F_1^p n_1 + F_2^p n_2 + \dots + F_n^p n_n}{n}}$$

Where:

$F_m$  - constant mean load, kN

$F_1, F_2, F_n$  - constant load during  $n_1, n_2, \dots, n_n$  revolutions, kN

$n$  - total number of revolutions ( $n=n_1+n_2+\dots+n_n$ ) during which loads  $F_1, F_2, \dots, F_n$  are acting

$p$  - exponent,

$p=3$  - for ball bearings

$p=10/3$  - for roller bearings

If the bearing speed is constant and the magnitude of load is between the minimum value  $F_{min}$  and a maximum value  $F_{max}$ , as shown in fig. 3 a and b, the mean load can be obtained from:

$$F_m = \frac{F_{min} + 2F_{max}}{3}, \text{ kN}$$

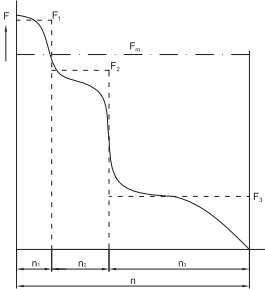

Fig. 2 a

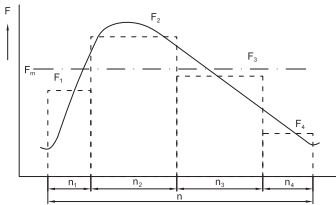

Fig. 2 b

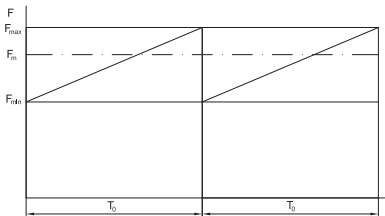

Fig. 3 a

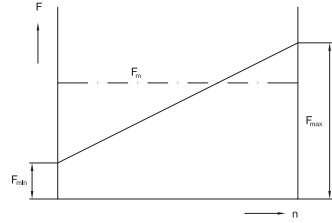

Fig. 3 b

If the external radial load consists in a load  $F_1$  - constant as magnitude and direction) and a load  $F_2$  - variable as direction and constant as magnitude ( $F_1, F_2$  acting in the same plane) as shown in fig. 4, the mean load can be determined using the equation:

$$F_m = f_m(F_1 + F_2), \text{ kN}$$

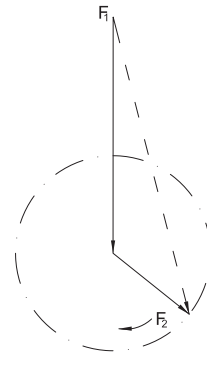

Fig. 4

Values for the factor  $f_m$  can be obtained from fig.5.

In case of sinusoidal movement as it shown in fig.6, the mean load can be obtained from equation:

$$F_m = \sqrt[3]{\frac{4}{3\pi} F_{max}^3}, \text{ kN}$$

$F_m \approx 0,75 F_{max}$ , kN, for ball bearings

$F_m \approx 0,77 F_{max}$ , kN, for roller bearings



In case of oscillating movements with angle  $\gamma$ , as shown in fig. 7, equivalent mean load can be calculated with the equation:

$$F_m = \sqrt[p]{\frac{\gamma}{90^\circ}} F_r, \text{ kN}$$

If the fluctuating load acts in a pure radial direction for radial bearings and in a pure axial direction for thrust bearings, the equivalent dynamic bearing load will be:

$$P_r = F_m$$

For combined loads, with radial load  $F_r$  and axial load  $F_a$  constant in direction and magnitude, the equivalent dynamic load can be calculated using the equation:

$$P_r = X F_r + Y F_a, \text{ kN}$$

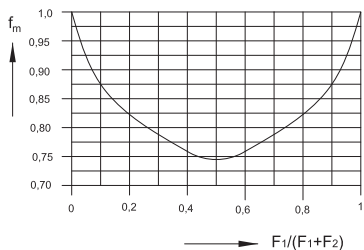

Fig. 5

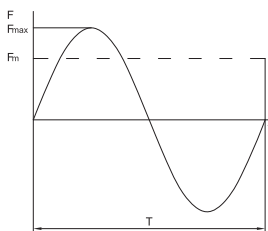

Fig. 6

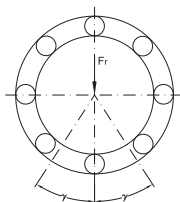

Fig. 7

In case of combined loads, with radial and axial loads changing in time, ratio  $F_r/F_a$  being constant, the equivalent dynamic load can be calculated by:

$$P_m = X F_{rm} + Y F_{am}, \text{ kN}$$

where:

$P_m$  - equivalent mean dynamic load, kN

$F_{rm}$  - radial mean load, kN

$F_{am}$  - axial mean load, kN

X, Y - factors of radial and axial load.

If direction and magnitude of load changes in time and speeds fluctuates in time, the equivalent mean dynamic load will be calculated using the equation:

$$P_m = \sqrt[p]{\frac{P_1^p n_1 + P_2^p n_2 + \dots + P_n^p n_n}{n}}$$

where:

$P_m$  - equivalent mean dynamic load, kN

$P_1$  - equivalent dynamic load for  $n_1$  revolutions, kN

$P_2$  - equivalent dynamic load for  $n_2$  revolutions, kN

$P_n$  - equivalent dynamic load for  $n_n$  revolutions, kN

$n_1$  - number of revolutions for load  $P_1$

$n_2$  - number of revolutions for load  $P_2$

$n_n$  - number of revolutions for load  $P_n$

$n$  - number of revolutions ( $n = n_1 + n_2 + \dots + n_n$ )

$p$  - exponent: - 3 for ball bearings,

- 10/3 for roller bearings

### Basic dynamic load of a bearing group

If heavy radial loads must be carried, it is required a bearing group of the same type, mounted close together, especially in case of ball and roller bearings. In order to take over the load uniformly, these bearings should be mounted with equal diameter deviations and also radial clearances. These deviations must be kept below half of the admitted tolerance class.

Basic dynamic load for a bearing group, as a function of the basic load of the single bearing, can be calculated using the equation:

$$C_{ri} = C_r i^n,$$

where:

$C_{ri}$  - basic dynamic load of the bearing group, kN

$C_r$  - basic dynamic load of the single bearing,



selected from the tables,

$i$  - number of bearings of the same type, mounted close together,

$n$  - exponent depending on the bearing type:

0,7 - for ball bearings

7/9 - for roller bearings

Values of  $i^n$  are given in table 2.6.

$i$	$i^{0,7}$	$i^{7/9}$
2	1,62	1,71
3	2,16	2,35
4	2,64	2,94

The equivalent basic dynamic load for each group of bearings is calculated considering specifications in the introductory text preceding the respective group.

### Adjusted rating life

Basic rating life  $L_{10}$  is often satisfactory for bearing performances. This life means a reliability of 90% for standard material and modern and usual manufacturing technologies, as well as for conventional operating conditions.

For a reliability over 90%, international standards recommends steels elaborated in better conditions, high level manufacturing technologies and specific operating conditions. In this case adjusted rated life can be calculated as follows:

$$L_{na} = a_1 a_2 a_3 L_{10} \text{ or } L_{na} = a_1 a_2 a_3 \left(\frac{C}{P}\right)^p$$

where:

$L_{na}$  – adjusted rating life, millions of revolutions

$a_1$  - life adjustment factor considering reliability

$a_2$  - life adjustment factor considering the material and manufacturing conditions

$a_3$  - life adjustment factor considering the operating conditions.

In case of life adjustment factors  $a_1, a_2, a_3$

greater than 1, when calculating adjusted rating life, prudence is recommended, because knowledge about bearings manufacture and operating conditions (shaft bending, housing stiffness, lubrication, temperature influence, etc.).

Values of the life adjustment factor  $a_1$  for reliabilities over 90% are given in table 2.7.

Reliability %	$L_{na}$	$a_1$
90	L10a	1
95	L5a	0,62
96	L4a	0,53
97	L3a	0,44
98	L2a	0,33
99	L1a	0,21

### Life adjustment factor $a_2$ for material

Life adjustment factor  $a_2$  takes into account the material properties, heat treatment of the steel and manufacturing technologies. For URB bearings,  $a_2=1$  is recommended.

### Life adjustment factor $a_{23}$ for operating conditions

The maximum life of a bearing can be reached in case of hydrodynamical lubrication, namely where is no direct contact between rolling elements and raceways due to the lubricant film. In this field, many studies have been done by world leading bearing manufacturers. These studies showed that there is a relationship between life adjustment factor  $a_2$  for material and life adjustment factor  $a_3$  for operating conditions. Preferably these factors should be unified, obtaining factor  $a_{23}$ . In this case, adjusted rating life would be:

$$L_{na} = a_1 a_{23} L_{10}$$

These values of  $a_{23}$  factor depends on the lubricant used, namely on the ratio between the oil viscosity



required at +40°C,  $\nu$  (initial value) to the viscosity required for adequate lubrication at the operating temperature  $\nu_1$ . The values are given in table 2.8.

Values for factor $a_{23}$									
Table 2.8									
$\frac{\nu}{\nu_1}$	0,1	0,2	0,5	1	1,5	2	3	4	5
$a_{23}$	0,45	0,55	0,75	1	1,3	1,6	2	2,5	2,5

The value of viscosity  $\nu_1$ , as a function of the mean bearing diameter and operating speed, are given in diagram fig. 8.

Kinematic viscosity  $\nu$  at the temperature of +40°C can be determined from diagram fig. 9, in accordance with ISO, if the bearing operating temperature is known.

In case of grease lubrication, calculation should be done considering the basic oil viscosity and the value of the life adjustment factor  $a_{23}$  will be smaller than 1.

Example of oil kinematic viscosity calculation for bearing lubrication:

The bearing 6212 operates at a speed of 3500 rpm and a temperature of +70° C.

Mean diameter will be:

$$D_m = 0,5(d+D) = 0,5(60+110) = 85 \text{ mm}$$

From the diagram fig. 9, at a temperature of +70° C, for a viscosity  $\nu_1 = 8 \text{ mm}^2/\text{s}$ , the viscosity at +40° C is  $20 \text{ mm}^2/\text{s}$  (Cst).

In this case should be selected an oil in accordance with ISO VG 22 with kinematic viscosity limits:  $\nu_{\min} = 19,8 \text{ mm}^2/\text{s}$  (cSt) and  $\nu_{\max} = 24,2 \text{ mm}^2/\text{s}$  (cSt).

In case of bearing operating at temperatures higher than +150°C, an adjustment factor  $f_t$  for temperature should be added to the life adjustment factor  $a_{23}$ . Adjusted rating life will be:

$$L_{na} = a_1 a_{23} f_t L_{10}$$

Values for the life adjustment factor  $f_t$  for temperature are given in table 2.9.

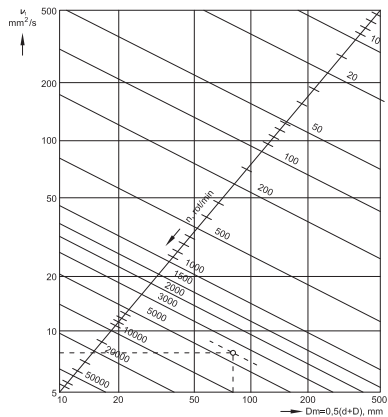

Fig. 8

Values for temperature factor $f_t$				
Table 2.9				
Operating temperature t°C	150	200	250	300
$f_t$	1	0,73	0,42	0,22

### Static load

When the bearing is stationary or rotates at slow movements or very low speeds (lower than 10 rpm), basic static load is not determined by the material fatigue but by permanent deformation caused at the rolling element/raceway contact.

It is also the case of rotating bearings, when they have to sustain heavy shock loads which act during a fraction of their revolution.

Generally, the value of the load may increase up to the value of the basic static load  $C_0$ , without altering the bearing operating properties.

### Equivalent static load

Combined static load (radial and axial load acting simultaneously on bearing) must be converted into an equivalent static bearing load. This is defined as the load (radial for radial bearings and axial for thrust bearings) which is applied, and would cause the

same permanent deformation in the bearing as the real load operating over it.

Equivalent static load is obtained from the general equation:

$$P_0 = X_0 F_r + Y_0 F_a, \text{ kN},$$

where:

- $P_0$  - equivalent bearing static load, kN,
- $F_r$  - radial component of the heaviest static load, kN,
- $F_a$  - axial component of the heaviest static load, kN,
- $X_0$  - radial load factor of the bearing,
- $Y_0$  - axial load factor of the bearing.

Data needed to calculate equivalent static load can be found in text and in bearing tables.

### Requisite basic static load rating

When determining bearing size on the basis of the static load, a static safety factor  $s_0$  is used.

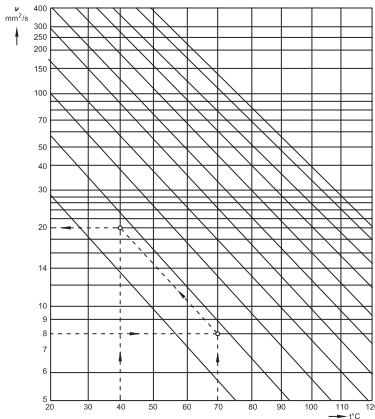

Fig. 9

The requisite basic static load is calculated using the equation:

$$C_{r0} = s_0 P_{r0}, \text{ kN}$$

where:

- $C_{r0}$  - basic static load rating, kN
- $s_0$  - static safety factor, table 2.11

$P_{r0}$  - equivalent static load, kN.

At high temperatures, life of the material decreases and the static load carrying capacity of bearings is reduced.

For high temperatures, basic static load is calculated using the equation:

$$C_{r0} = f_{0t} s_0 P_{r0}, \text{ kN}$$

The values of factor  $f_{0t}$  depending on temperature is given in table 2.10.

Operating temperature t°C	150	200	250	300
$f_{0t}$	1	0,95	0,85	0,75

### Non – rotating bearings

In case of non-rotating bearings, values of static safety factor  $s_0$ , for certain applications are given in table 2.11. These values are also valid for bearings with oscillating movements.

Application	$s_0$
Variable pitch propeller for aircraft	0,5
Dam gates, flood gates	
Opening bridges	1,5
Crane hooks for:	
*large cranes without additional loads	1,5
*small cranes with additional dynamic loads	1,6

### Rotating bearings

In case of fluctuating or oscillating loads and especially when heavy shock loads are acting during a fraction of revolution, it is necessary to check if the bearing has the proper static load carrying capacity. Heavy shock loads, higher than the basic static



bearing load, produce permanent deformations not uniformly distributed on raceway, which influence negatively bearing running.

Generally, heavy shock loads cannot be exactly calculated and in certain cases they produce deformations of bearing housing and consequently an unfavorable load distribution in bearing.

When a bearing rotates under maximum load, raceway becomes uniformly deformed on all its outer surface without any imprint.

For various operating conditions, maximum load acting upon the bearing is calculated with static safety factor  $s_0$ , depending on the vibrations and shock loads.

The values of static safety factor are given in table 2.12.

mounted close together to take over a static load, the load magnitude supported by these bearings will be calculated from:

$$C_{Ort} = C_{Or} i,$$

where:

$C_{Ort}$  - basic static load of the bearing group

$C_{Or}$  - basic static load of the single bearing (catalogue)

$i$  - number of bearings.

Values for static safety factor $s_0$						
Type of operation	Requirements regarding quiet running					
	Unimportant		Normal		High	
	Ball bearings	Roller	Ball bearings	Roller	Ball bearings	Roller
Smooth, vibration-free	0,5	1	1	1,5	2	3
Normal	0,5	1	1	1,5	2	3,5
Heavy shock loads	>1,5	>2,5	>1,5	>3	>2	>4

For bearing with a known equivalent static load, static safety factor  $s_0$  is necessary to be checked using the equation:

$$s_0 = \frac{C_{ro}}{P_{ro}}$$

If the value of  $s_0$  is less than recommended in table 2.12, then a bearing with a higher basic static load carrying capacity should be selected.

### Basic static load for a group of bearings

Where more bearings of the same type are

# Bearing tolerances

Bearing tolerances have been internationally standardized in accordance with ISO 492, ISO 199, ISO 582, ISO 1132.

Bearings are generally manufactured to the tolerance class P0. At request, they can also be manufactured to the tolerance classes P6, P6x, P5, P4 and P2. These bearings are used for special applications, such as very accurate shaft guidance or very high speeds.

The values of the limit deviations for these tolerance classes are given for:

- the overall dimensions of:
  - deep groove ball bearings, angular contact ball bearings, self-aligning ball bearings, spherical roller bearings, cylindrical roller bearings, tapered roller bearings,
  - tapered roller bearing with metric (mm) and inch dimensions,
  - tapered bore bearings,
  - thrust ball bearings, angular contact thrust ball bearings, cylindrical roller thrust bearings, needle roller thrust bearings.
- mounting chamfer.

## Symbols

- $d$  - nominal bore diameter or shaft washer nominal bore diameter for thrust bearings
- $d_1$  - nominal diameter at the theoretical large end of the tapered bore
- $d_2$  - nominal bore diameter of the shaft washer for double directions thrust bearings
- $d_s$  - deviation of single bore diameter
- $d_{psmax}$  - maximum bore diameter, in a single radial plane
- $d_{psmin}$  - minimum bore diameter, in a single radial plane
- $\Delta d_s$  - deviation of a single bore diameter  $\Delta d_s = d_s - d$
- $d_{mp}$  - mean bore diameter, in a single radial

- plane  $d_{mp} = (d_{psmax} + d_{psmin})/2$
- $\Delta d_{mp}$  - deviation of the mean bore diameter in a single radial plane; or deviation of the mean diameter at the theoretical small end of the tapered bore, in case of tapered bore bearings; or deviation of the mean bore diameter of the shaft washer in a single direction thrust bearings  $\Delta d_{mp} = d_{mp} - d$
- $\Delta d_{1mp}$  - deviation of the mean diameter at the theoretical large end of the tapered bore  $\Delta d_{1mp} = d_{1mp} - d$
- $\Delta d_{2mp}$  - deviation of the mean bore diameter of the shaft washer for a double directions thrust bearings, in a single radial plane
- $V_{dp}$  - bore diameter variation in a single radial plane; or bore diameter variation of the shaft washer in a single radial place, for single thrust bearings  $V_{dp} = d_{psmax} - d_{psmin}$
- $V_{d2p}$  - bore diameter variation of the shaft washer for double directions thrust bearings, in a single radial plane
- $V_{dmp}$  - mean bore diameter variation (valid only for cylindrical bore)  $V_{dmp} = d_{mpmax} - d_{mpmin}$
- $\alpha$  - nominal half-angle of the tapered bore
- $D$  - nominal outside diameter or housing washer nominal diameter
- $D_1$  - nominal outside diameter of the outer ring rib
- $D_s$  - single outside diameter maximum
- $D_{psmax}$  - outside diameter in a single radial plane maximum outside diameter in a single radial plane
- $D_{psmin}$  - outside diameter in a single radial plane minimum outside diameter in a single radial plane deviation of the single outside diameter  $\Delta D_s = D_s - D$
- $\Delta D_s$  - mean outside diameter, in a single plane  $= (D_{psmax} + D_{psmin})/2$
- $D_{mp}$  - deviation of the mean outside diameter in a single radial plane; or deviation of the mean diameter of housing washer in a single radial plane, for thrust bearings  $\Delta D_{mp} = D_{mp} - D$
- $\Delta D_{Dmp}$  - the mean diameter of housing washer in a single radial plane, for thrust bearings  $\Delta D_{mp} = D_{mp} - D$
- $V_{DP}$  - outside diameter variation in a single



- $V_{Dmp}$  - mean outside diameter variation
- $B$  - nominal width of the inner ring
- $B_s$  - single width of the inner ring
- $\Delta B_s$  - inner ring single width deviation  
 $\Delta B_s = B_s - B$
- $V_{Bs}$  - inner ring single width variation
- $C$  - nominal width of the outer ring
- $C_s$  - single width of the outer ring
- $\Delta C_s$  - deviation of the outer ring single width  
 $\Delta C_s = C_s - C$
- $V_{Cs}$  - single width variation of the outer ring  
 $V_{Cs} = C_{smax} - C_{smin}$
- $T$  - nominal width of tapered roller bearings
- $T_s$  - single width of tapered roller bearings
- $\Delta T_s$  - deviation of the single width of tapered roller bearings  $\Delta T_s = T_s - T$
- $T_1$  - nominal width of the inner ring and tapered roller assembly
- $T_{1s}$  - single width of the inner ring and tapered roller assembly
- $\Delta T_{1s}$  - deviation of the single width of inner ring and tapered roller assembly  
 $\Delta T_{1s} = T_{1s} - T_1$
- $T_2$  - nominal width of the outer ring assembly
- $T_{2s}$  - single width of the outer ring assembly

- $\Delta T_{2s}$  - deviation of the single width of outer ring assembly  $\Delta T_{2s} = T_{2s} - T_2$
- $K_{ia}$  - radial runout of assembled bearing inner ring
- $K_{ea}$  - radial runout of assembled bearing outer ring
- $S_d$  - side face runout with reference to bore of the inner ring
- $S_D$  - variation in inclination of outside cylindrical surface to outer ring side face
- $S_{ia}$  - side face runout of assembled inner ring with reference to raceway
- $S_{ea}$  - side face runout of assembled outer ring with reference to raceway
- $S_i$  - thickness variation measured from middle of raceway to back seating face of shaft washer
- $S_e$  - thickness variation measured from middle of raceway to back face of housing washer
- $\Delta H_s$  - deviation of mounting height of single direction thrust ball and roller bearings
- $\Delta H_{1s}$  - deviation of mounting height of thrust ball bearings with sphered housing washer
- $\Delta H_{2s}$  - deviation of mounting height of double direction thrust ball and roller bearings,
- $\Delta H_{3s}$  - deviation of mounting height of double direction thrust ball bearings with sphered housing washer.

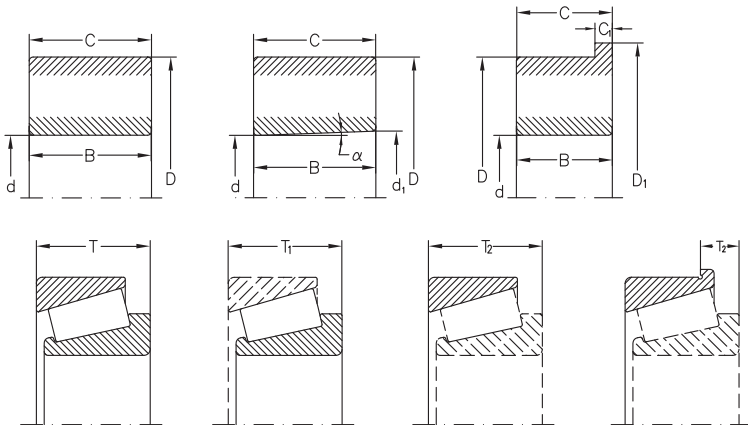

**Radial bearings (excepting tapered roller bearings)**  
**Tolerance class P0**

**Table 3.1** Deviations in  $\mu\text{m}$  **Inner ring**

d mm		$\Delta d_{mp}$		$V_{dp}$			$V_{dmp}$	$K_{ia}$	$\Delta B_s$			$V_{Bs}$
				Diameter series					all	normal	modified <sup>2)</sup>	
				7,8,9	0,1	2,3,4						
over	up to	high	low	max.	max.	max.	max.	max.	high	low	low	max.
<b>0,6</b> <sup>1)</sup>	<b>2,5</b>	0	-8	10	8	6	6	10	0	-40	-	12
<b>2,5</b>	<b>10</b>	0	-8	10	8	6	6	10	0	-120	-250	15
<b>10</b>	<b>18</b>	0	-8	10	8	6	6	10	0	-120	-250	20
<b>18</b>	<b>30</b>	0	-10	13	10	8	8	13	0	-120	-250	20
<b>30</b>	<b>50</b>	0	-12	15	12	9	9	15	0	-120	-250	20
<b>50</b>	<b>80</b>	0	-15	19	19	11	11	20	0	-150	-380	25
<b>80</b>	<b>120</b>	0	-20	25	25	15	15	25	0	-200	-380	25
<b>120</b>	<b>180</b>	0	-25	31	31	19	19	30	0	-250	-500	30
<b>180</b>	<b>250</b>	0	-30	38	38	23	23	40	0	-300	-500	30
<b>250</b>	<b>315</b>	0	-35	44	44	26	26	50	0	-350	-500	35
<b>315</b>	<b>400</b>	0	-40	50	50	30	30	60	0	-400	-630	40
<b>400</b>	<b>500</b>	0	-45	56	56	34	34	65	0	-450	-	50
<b>500</b>	<b>630</b>	0	-50	63	63	38	38	70	0	-500	-	60
<b>630</b>	<b>800</b>	0	-75	-	-	-	-	80	0	-750	-	70

1) This value included.  
2) If refers to isolated bearing ring for paired mounting or sets of 3 or 4 bearing.

**Table 3.2** Deviations in  $\mu\text{m}$  **Outer ring**

D mm		$\Delta D_{mp}$		$V_{Dp}^{3)}$				$V_{Dmp}^{3)}$	$K_{ea}$	$\Delta C_s$		$V_{Cs}$
				Open bearings			Shielded					
							Bearings <sup>2)</sup>					
				Diameter series								
7,8,9	0,1	2,3,4	2,3,4	max.	max.	max.	max.	max.	high	low	max.	
over	up to	high	low	max.	max.	max.	max.	max.	max.	high	low	max.
<b>2,5</b> <sup>1)</sup>	<b>6</b>	0	-8	10	8	6	10	6	15	Values are identical to $\Delta B_s$ and $V_{Bs}$ for the inner ring of the same bearing.		
<b>6</b>	<b>18</b>	0	-8	10	8	6	10	6	15			
<b>18</b>	<b>30</b>	0	-9	12	9	7	12	7	15			
<b>30</b>	<b>50</b>	0	-11	14	11	8	16	8	20			
<b>50</b>	<b>80</b>	0	-13	16	13	10	20	10	25			
<b>80</b>	<b>120</b>	0	-15	19	19	11	26	11	35			
<b>120</b>	<b>150</b>	0	-18	23	23	14	30	14	40			
<b>150</b>	<b>180</b>	0	-25	31	31	19	38	19	45			
<b>180</b>	<b>250</b>	0	-30	38	38	23	-	23	50			
<b>250</b>	<b>315</b>	0	-35	44	44	26	-	26	60			
<b>315</b>	<b>400</b>	0	-40	50	50	30	-	30	70			
<b>400</b>	<b>500</b>	0	-45	56	56	34	-	34	80			
<b>500</b>	<b>630</b>	0	-50	63	63	38	-	38	100			
<b>630</b>	<b>800</b>	0	-75	94	94	55	-	55	120			
<b>800</b>	<b>1000</b>	0	-100	125	125	75	-	75	140			

1) This value included.  
2) For bearings of diameter series 7,8,9,0, and 1 values are not indicated.  
3) Values are valid before mounting the snap ring or shields or after their dismounting.



Tolerance class P6

Deviations in $\mu\text{m}$												Inner ring		Table 3.3
d mm		$\Delta d_{mp}$		$V_{dp}$			$V_{dmp}$	$K_{ia}$	$\Delta B_s$			$V_{Bs}$		
				Diameter series					all	normal	modified <sup>2)</sup>			
				7,8,9	0,1	2,3,4								
over	up to	high	low	max.	max.	max.	max.	max.	high	low	low	max.		
0	2,5	0	-7	9	7	5	5	5	0	-40	-	12		
2,5	10	0	-7	9	7	5	5	6	0	-120	-250	15		
10	18	0	-7	9	7	5	5	7	0	-120	-250	20		
18	30	0	-8	10	8	6	6	8	0	-120	-250	20		
30	50	0	-10	13	10	8	8	10	0	-120	-250	20		
50	80	0	-12	15	15	9	9	10	0	-150	-380	25		
80	120	0	-15	19	19	11	11	13	0	-200	-380	25		
120	180	0	-18	23	23	14	14	18	0	-250	-500	30		
180	250	0	-22	28	28	17	17	20	0	-300	-500	30		
250	315	0	-25	31	31	19	19	25	0	-350	-500	35		
315	400	0	-30	38	38	23	23	30	0	-400	-630	40		
400	500	0	-35	44	44	26	26	35	0	-450	-	45		
500	630	0	-40	50	50	30	30	40	0	-500	-	50		

1) This value included.  
2) It refers to isolated bearing ring for paired mounting or sets of 3 or 4 bearing.

Deviations in $\mu\text{m}$												Outer ring		Table 3.4
D mm		$\Delta D_{mp}$		$V_{Dp}^{3)}$				$V_{Dmp}^{3)}$	$K_{oa}$	$\Delta C_s$		$V_{Cs}$		
				Open bearings			Shielded Bearings <sup>2)</sup>							
				Diameter series										
				7,8,9	0,1	2,3,4	2,3,4							
over	up to	high	low	max.	max.	max.	max.	max.	max.	high	low	max.		
2,5 <sup>1)</sup>	6	0	-7	9	7	5	9	5	8	Values are identical to $\Delta B_s$ and $V_{Bs}$ for the inner ring				
6	18	0	-7	9	7	5	9	5	8					
18	30	0	-8	10	8	6	10	6	9					
30	50	0	-9	11	9	7	13	7	10					
50	80	0	-11	14	11	8	16	8	13					
80	120	0	-13	16	16	10	20	10	18					
120	150	0	-15	19	19	11	25	11	20					
150	180	0	-18	23	23	14	30	14	23					
180	250	0	-20	25	25	15	-	15	25					
250	315	0	-25	31	31	19	-	19	30					
315	400	0	-28	35	35	21	-	21	35					
400	500	0	-33	41	41	25	-	25	40					
500	630	0	-38	48	48	29	-	29	50					
630	800	0	-45	56	56	34	-	34	60					
800	1000	0	-60	75	75	45	-	45	75					

1) This value included.  
2) For bearings of diameter series 7,8 and 9 values are not indicated.  
3) Values are valid before mounting the snap ring or shields or after their dismounting.



### Tolerance class P5

Inner ring													
Deviations in $\mu\text{m}$													
d mm		$\Delta d_{mp}$		$V_{dp}$		$V_{dmp}$	$K_{Ia}$	$S_d$	$S_{Ia}^{2)}$	$\Delta B_s$			$V_{Bs}$
				Diameter series						all	normal	modified <sup>3)</sup>	
				7,8,9	0,1,2,3,4								
over	up to	high	low	max.	max.	max.	max.	max.	high	low	low	max.	
<b>0,6</b> <sup>1)</sup>	<b>2,5</b>	0	-5	5	4	3	4	7	7	0	-40	-250	5
<b>2,5</b>	<b>10</b>	0	-5	5	4	3	4	7	7	0	-40	-250	5
<b>10</b>	<b>18</b>	0	-5	5	4	3	4	7	7	0	-80	-250	5
<b>18</b>	<b>30</b>	0	-6	6	5	3	4	8	8	0	-120	-250	5
<b>30</b>	<b>50</b>	0	-8	8	6	4	5	8	8	0	-120	-250	5
<b>50</b>	<b>80</b>	0	-9	9	7	5	5	8	8	0	-150	-250	6
<b>80</b>	<b>120</b>	0	-10	10	8	5	6	9	9	0	-200	-380	7
<b>120</b>	<b>180</b>	0	-13	13	10	7	8	10	10	0	-250	-380	8
<b>180</b>	<b>250</b>	0	-15	15	12	8	10	11	13	0	-300	-500	10
<b>250</b>	<b>315</b>	0	-18	18	14	9	13	13	15	0	-350	-500	13
<b>315</b>	<b>400</b>	0	-25	25	18	12	15	15	20	0	-400	-630	15

1) This value included.

2) Applies only to ball bearings.

3) If refers to single bearing ring for paired mounting or sets of 3 or 4 bearing.

Outer ring													
Deviations in $\mu\text{m}$													
D mm		$\Delta D_{mp}$		$V_{Dp}^{2)}$		$V_{Dmp}^{3)}$	$K_{Ca}$	$S_D$	$S_{Ca}^{3)}$	$\Delta C_s$		$V_{Cs}$	
				7,8,9	0,1,2,3,4					high	low		
				max.	max.								
over	up to	high	low	max.	max.	max.	max.	max.	max.	high	low	max.	
<b>2,5</b> <sup>1)</sup>	<b>6</b>	0	-5	5	4	3	5	8	8	Identical to $\Delta B_s$ and $V_{Bs}$ for the inner ring		5	
<b>6</b>	<b>18</b>	0	-5	5	4	3	5	8	8				5
<b>18</b>	<b>30</b>	0	-6	6	5	3	6	8	8				5
<b>30</b>	<b>50</b>	0	-7	7	5	4	7	8	8				5
<b>50</b>	<b>80</b>	0	-9	9	7	5	8	8	10				6
<b>80</b>	<b>120</b>	0	-10	10	8	5	10	9	11				8
<b>120</b>	<b>150</b>	0	-11	11	8	6	11	10	13				8
<b>150</b>	<b>180</b>	0	-13	13	10	7	13	10	14				8
<b>180</b>	<b>250</b>	0	-15	15	11	8	15	11	15				10
<b>250</b>	<b>315</b>	0	-18	18	14	9	18	13	18				11
<b>315</b>	<b>400</b>	0	-20	20	15	10	20	13	20				13
<b>400</b>	<b>500</b>	0	-23	23	17	12	23	15	23				15
<b>500</b>	<b>630</b>	0	-28	28	21	14	25	18	25				18
<b>630</b>	<b>800</b>	0	-35	35	26	18	30	20	30				20

1) This value included.

2) Do not apply to shielded bearings.

3) Apply to ball bearings.



Tolerance class P4

Deviations in $\mu\text{m}$														Table 3.7
Inner ring														
d mm		$\Delta d_{mp}, \Delta d_s^{2)}$		$V_{dp}$		$V_{dmp}$	$K_{ia}$	$S_d$	$S_{ia}^{3)}$	$\Delta B_s$			$V_{Bs}$	
				Diameter series						all	normal	modified <sup>4)</sup>		
				7,8,9	0,1,2,3,4									
over	up to	high	low	max.	max.	max.	max.	max.	max.	high	low	low	max.	
0,6 <sup>1)</sup>	2,5	0	-4	4	3	2	2,5	3	3	0	-40	-250	2,5	
2,5	10	0	-4	4	3	2	2,5	3	3	0	-40	-250	2,5	
10	18	0	-4	4	3	2	2,5	3	3	0	-80	-250	2,5	
18	30	0	-5	5	4	2,5	3	4	4	0	-120	-250	2,5	
30	50	0	-6	6	5	3	4	4	4	0	-120	-250	3	
50	80	0	-7	7	5	3,5	4	5	5	0	-150	-250	4	
80	120	0	-8	8	6	4	5	5	5	0	-200	-380	4	
120	180	0	-10	10	8	5	6	6	7	0	-250	-380	5	
180	250	0	-12	12	9	6	8	7	8	0	-300	-500	6	

- 1) This value included.
- 2) Apply only to bearings of diameter series 0,1,2,3,4.
- 3) Apply only to ball bearings.
- 4) It refers to single bearing ring for paired mounting or sets of 3 or 4 bearing.

Deviations in $\mu\text{m}$														Table 3.8
Outer ring														
D mm		$\Delta D_{mp}, \Delta D_s^{2)}$		$V_{Dp}^{3)}$		$V_{Dmp}$	$K_{ea}$	$S_D$	$S_{ea}^{4)}$	$\Delta C_s$		$V_{Cs}$		
				Diameter series						high	low			
				7,8,9	0,1,2,3,4									
over	up to	high	low	max.	max.	max.	max.	max.	max.	high	low	max.		
2,5 <sup>1)</sup>	6	0	-4	4	3	2	3	4	5	Identical to $\Delta B_s$ and $V_{Bs}$ for the inner ring		2,5		
6	18	0	-4	4	3	2	3	4	5		2,5			
18	30	0	-5	5	4	2,5	4	4	5		2,5			
30	50	0	-6	6	5	3	5	4	5		2,5			
50	80	0	-7	7	5	3,5	5	4	5		3			
80	120	0	-8	8	6	4	6	5	6		4			
120	150	0	-9	9	7	5	7	5	7		5			
150	180	0	-10	10	8	5	8	5	8		5			
180	250	0	-11	11	8	6	10	7	10		7			
250	315	0	-13	13	10	7	11	8	10		7			
315	400	0	-15	15	11	8	13	10	13	8				

- 1) This value included.
- 2) Apply to bearings of diameter series 0,1,2,3 and 4.
- 3) Do not apply to sealed and shielded bearings.
- 4) Apply only to ball bearings.

### Tolerance class P2

Deviations in $\mu\text{m}$												Inner ring		Table 3.9	
d mm		$\Delta d_{mp}, \Delta d_s^{2)}$		$V_{dp}$	$V_{dmp}$	$K_{ia}$	$S_d$	$S_{ia}^{2)}$ all	$\Delta B_s$		$V_{Bs}$				
												over	up to	high	low
<b>0,6</b> <sup>1)</sup>	<b>2,5</b>	0	-2,5	2,5	1,5	1,5	1,5	1,5	1,5	0	-40	1,5			
<b>2,5</b>	<b>10</b>	0	-2,5	2,5	1,5	1,5	1,5	1,5	1,5	0	-40	1,5			
<b>10</b>	<b>18</b>	0	-2,5	2,5	1,5	1,5	1,5	1,5	1,5	0	-80	1,5			
<b>18</b>	<b>30</b>	0	-2,5	2,5	1,5	2,5	1,5	2,5	2,5	0	-120	1,5			
<b>30</b>	<b>50</b>	0	-2,5	2,5	1,5	2,5	1,5	2,5	2,5	0	-120	1,5			
<b>50</b>	<b>80</b>	0	-4	4	2	2,5	1,5	2,5	2,5	0	-150	1,5			
<b>80</b>	<b>120</b>	0	-5	5	2,5	2,5	2,5	2,5	2,5	0	-200	2,5			
<b>120</b>	<b>150</b>	0	-7	7	3,5	2,5	2,5	2,5	2,5	0	-250	2,5			
<b>150</b>	<b>180</b>	0	-7	7	3,5	5	4	5	5	0	-300	4			
<b>180</b>	<b>250</b>	0	-8	8	4	5	5	5	5	0	-350	5			

1) This value included.

2) Apply only to ball bearings.

Deviations in $\mu\text{m}$												Outer ring		Table 3.10	
D mm		$\Delta D_{mp}, \Delta D_s$		$V_{Dp}$	$V_{Dmp}$	$K_{ea}$	$S_D^{2),3)}$	$S_{ea}^{3)}$	$\Delta C_s$		$V_{Cs}$				
												over	up to	high	low
<b>2,5</b> <sup>1)</sup>	<b>6</b>	0	-2,5	2,5	1,5	1,5	1,5	1,5	1,5	Identical to $\Delta B_s$ for the inner ring	1,5				
<b>6</b>	<b>18</b>	0	-2,5	2,5	1,5	1,5	1,5	1,5	1,5		1,5				
<b>18</b>	<b>30</b>	0	-4	4	2	2,5	1,5	2,5	2,5		1,5				
<b>30</b>	<b>50</b>	0	-4	4	2	2,5	1,5	2,5	2,5		1,5				
<b>50</b>	<b>80</b>	0	-4	4	2	4	1,5	4	4		1,5				
<b>80</b>	<b>120</b>	0	-5	5	2,5	5	2,5	5	5		2,5				
<b>120</b>	<b>150</b>	0	-5	5	2,5	5	2,5	5	5		2,5				
<b>150</b>	<b>180</b>	0	-7	7	3,5	5	2,5	5	5		2,5				
<b>180</b>	<b>250</b>	0	-8	8	4	7	4	7	7		4				
<b>250</b>	<b>315</b>	0	-8	8	4	7	5	7	7		5				
<b>315</b>	<b>400</b>	0	-10	10	5	8	7	8	8	7					

1) This value included.

2) Do not apply to bearings with rib on the outer ring.

3) Apply only to ball bearings



**Tolerance class SP**

**Inner ring**

Table 3.11

d mm		Cylindrical bore			Tapered bore					$\Delta B_s$		$V_{Bs}$	$K_{Ia}$	$S_d$	$S_{Ia}$	
		$\Delta d_{mp}, \Delta d_s$		$V_{dp}$	$\Delta d_s$		$V_{dp}$	$\Delta d_{1mp}, -\Delta d_{mp}$								
		over	up to	low	high	max.	low	high	max.	low	high	low	high	max.	max.	max.
-	<b>18</b>	-5	0	3	-	-	-	-	-	-	-100	0	5	3	8	8
<b>18</b>	<b>30</b>	-6	0	3	0	+10	3	0	+4	-100	0	5	3	8	8	
<b>30</b>	<b>50</b>	-8	0	4	0	+12	4	0	+4	-120	0	5	4	8	8	
<b>50</b>	<b>80</b>	-9	0	5	0	+15	5	0	+5	-150	0	6	4	8	8	
<b>80</b>	<b>120</b>	-10	0	5	0	+20	5	0	+6	-200	0	7	5	9	9	
<b>120</b>	<b>180</b>	-13	0	7	0	+25	7	0	+8	-250	0	8	6	10	10	
<b>180</b>	<b>250</b>	-15	0	8	0	+30	8	0	+10	-300	0	10	8	11	13	
<b>250</b>	<b>315</b>	-18	0	9	0	+35	9	0	+12	-350	0	13	10	13	15	
<b>315</b>	<b>400</b>	-23	0	12	0	+40	12	0	+13	-400	0	15	12	15	20	

**Outer ring**

Table 3.12

D mm		$\Delta D_{mp}, \Delta D_s$		$V_{Dp}$	$K_{Ea}$	$S_D$	$S_{Ea}$	$\Delta C_s$	$V_{Cs}$
		low	high	max.	max.	max.	max.		
over	up to	low	high	max.	max.	max.	max.	Identical to $\Delta B_s$ and $V_{Bs}$ for the inner ring	
<b>30</b>	<b>50</b>	-7	0	4	5	8	8		
<b>50</b>	<b>80</b>	-9	0	5	5	8	10		
<b>80</b>	<b>120</b>	-10	0	5	6	9	11		
<b>120</b>	<b>150</b>	-11	0	6	7	10	13		
<b>150</b>	<b>180</b>	-13	0	7	8	10	14		
<b>180</b>	<b>250</b>	-15	0	8	10	11	15		
<b>250</b>	<b>315</b>	-18	0	9	11	13	18		
<b>315</b>	<b>400</b>	-20	0	10	13	13	20		
<b>400</b>	<b>500</b>	-23	0	12	15	15	23		

### Tolerance class UP

Deviations in $\mu\text{m}$																			
d mm		Inner ring										$\Delta B_s$				$V_{Bs}$	$K_{Ia}$	$S_d$	$S_{Ia}$
		Cylindrical bore			Tapered bore														
		$\Delta d_{mp}, \Delta d_s$		$V_{dp}$	$\Delta d_s$		$V_{dp}$	$\Delta d_{imp}, -\Delta d_{mp}$											
over	up to	low	high	max.	low	high	max.	low	high	low	high	max.	max.	max.	max.				
-	18	-4	0	2	0	-	-	-	-	-25	0	1,5	1,5	2	3				
18	30	-5	0	3	0	+6	3	0	+2	-25	0	1,5	1,5	3	3				
30	50	-6	0	3	0	+8	3	0	+3	-30	0	2	2	3	3				
50	80	-7	0	4	0	+9	4	0	+3	-40	0	3	2	4	3				
80	120	-8	0	4	0	+10	4	0	+4	-50	0	3	3	4	4				
120	180	-10	0	5	0	+13	5	0	+5	-60	0	4	3	5	6				
180	250	-12	0	6	0	+15	6	0	+7	-75	0	5	4	6	7				
250	315	-18	0	9	0	+18	9	0	+8	-90	0	6	5	6	8				
315	400	-23	0	12	0	+23	12	0	+9	-100	0	8	6	8	9				

Table 3.13

Deviations in $\mu\text{m}$										
Outer ring										
D mm		$\Delta D_{mp}, \Delta D_s$		$V_{Dp}$	$K_{ea}$	$S_D$	$S_{ea}$	$\Delta C_s$	$V_{Cs}$	
over	up to	low	high	max.	max.	max.	max.	high	max.	
30	50	-5	0	3	3	2	4	Identical to $\Delta B_s$ and $V_{Bs}$ for the inner ring		
50	80	-6	0	3	3	2	4			
80	120	-7	0	4	3	3	5			
120	150	-8	0	4	4	3	6			
150	180	-9	0	5	4	3	7			
180	250	-10	0	5	5	4	9			
250	315	-12	0	6	6	4	9			
315	400	-14	0	7	7	5	12			
400	500	-23	0	12	8	-	12			

Table 3.14



**3.2 Tapered Roller Bearings  
Tolerance class P0 and P0X**

Deviations in $\mu\text{m}$		Inner ring					Table 3.15
d mm		$\Delta d_{mp}$		$V_{dp}$	$V_{dmp}$	$K_{ia}$	
over	up to	high	low	max.	max.	max.	
<b>10</b> <sup>1)</sup>	<b>18</b>	0	-12	12	9	15	
<b>18</b>	<b>30</b>	0	-12	12	9	18	
<b>30</b>	<b>50</b>	0	-12	12	9	20	
<b>50</b>	<b>80</b>	0	-15	15	11	25	
<b>80</b>	<b>120</b>	0	-20	20	15	30	
<b>120</b>	<b>180</b>	0	-25	25	19	35	
<b>180</b>	<b>250</b>	0	-30	30	23	50	
<b>250</b>	<b>315</b>	0	-35	35	26	60	
<b>315</b>	<b>400</b>	0	-40	40	30	70	

1) This value included.

Deviations in $\mu\text{m}$		Outer ring					Table 3.16
D mm		$\Delta D_{mp}$		$V_{Dp}$	$V_{Dmp}$	$K_{ea}$	
over	up to	high	low	max.	max.	max.	
<b>18</b> <sup>1)</sup>	<b>30</b>	0	-12	12	9	18	
<b>30</b>	<b>50</b>	0	-14	14	11	20	
<b>50</b>	<b>80</b>	0	-16	16	12	25	
<b>80</b>	<b>120</b>	0	-18	18	14	35	
<b>120</b>	<b>150</b>	0	-20	20	15	40	
<b>150</b>	<b>180</b>	0	-25	25	19	45	
<b>180</b>	<b>250</b>	0	-30	30	23	50	
<b>250</b>	<b>315</b>	0	-35	35	26	60	
<b>315</b>	<b>400</b>	0	-40	40	30	70	
<b>400</b>	<b>500</b>	0	-45	45	34	80	

1) This value included.

Note: Limit deviations of the diameter D1 of the outer ring rib for bearings with ribs are in accordance with tolerance class h9.

**Tolerance class P0**

Deviations in $\mu\text{m}$		Inner and outer ring								Table 3.17
d mm		$\Delta B_s, \Delta D_s$		$\Delta T_s$		$\Delta T_{1s}$		$\Delta T_{2s}$		
over	up to	high	low	high	low	high	low	high	low	
<b>10</b> <sup>1)</sup>	<b>18</b>	0	-120	+200	0	+100	0	+100	0	
<b>18</b>	<b>30</b>	0	-120	+200	0	+100	0	+100	0	
<b>30</b>	<b>50</b>	0	-120	+200	0	+100	0	+100	0	
<b>50</b>	<b>80</b>	0	-150	+200	0	+100	0	+100	0	
<b>80</b>	<b>120</b>	0	-200	+200	-200	+100	-100	+100	-100	
<b>120</b>	<b>180</b>	0	-250	+350	-250	+150	-150	+200	-100	
<b>180</b>	<b>250</b>	0	-300	+350	-250	+150	-150	+200	-100	
<b>250</b>	<b>315</b>	0	-350	+350	-250	+150	-150	+200	-100	
<b>315</b>	<b>400</b>	0	-400	+400	-400	+200	-200	+200	-200	

1) This value included.



**Tolerance class P6X  
Inner and outer ring**

Diameter limit deviations and radial runout of the inner and outer ring of this tolerance class are the same as those of tolerance class P<sub>0</sub>

**Deviations in  $\mu\text{m}$**  Table 3.18

d mm		$\Delta B_s$		$\Delta C_s$		$\Delta T_s$		$\Delta T_{1s}$		$\Delta T_{2s}$	
over	up to	high	low	high	low	high	low	high	low	high	low
<b>10</b> <sup>1)</sup>	<b>18</b>	0	-50	0	-100	+100	0	+50	0	+50	0
<b>18</b>	<b>30</b>	0	-50	0	-100	+100	0	+50	0	+50	0
<b>30</b>	<b>50</b>	0	-50	0	-100	+100	0	+50	0	+50	0
<b>50</b>	<b>80</b>	0	-50	0	-100	+100	0	+50	0	+50	0
<b>80</b>	<b>120</b>	0	-50	0	-100	+100	0	+50	0	+50	0
<b>120</b>	<b>180</b>	0	-50	0	-100	+150	0	+50	0	+100	0
<b>180</b>	<b>250</b>	0	-50	0	-100	+150	0	+50	0	+100	0
<b>250</b>	<b>315</b>	0	-50	0	-100	+200	0	+100	0	+100	0
<b>315</b>	<b>400</b>	0	-50	0	-100	+200	0	+100	0	+100	0

1) This value included.

**Tolerance class P5**

**Deviations in  $\mu\text{m}$**  Table 3.19

**Inner ring**

d mm		$\Delta d_{mp}$		$V_{dp}$	$V_{dmp}$	$K_{Ia}$	$S_d$	$\Delta B_s$		$\Delta T_s$	
over	up to	high	low	max.	max.	max.	max.	high	low	high	low
<b>10</b> <sup>1)</sup>	<b>18</b>	0	-7	5	5	5	7	0	-200	+200	-200
<b>18</b>	<b>30</b>	0	-8	6	5	5	8	0	-200	+200	-200
<b>30</b>	<b>50</b>	0	-10	8	5	6	8	0	-240	+200	-200
<b>50</b>	<b>80</b>	0	-12	9	6	7	8	0	-300	+200	-200
<b>80</b>	<b>120</b>	0	-15	11	8	8	9	0	-400	+200	-200
<b>120</b>	<b>180</b>	0	-18	14	9	11	10	0	-500	+350	-250
<b>180</b>	<b>250</b>	0	-22	17	11	13	11	0	-600	+350	-250

1) This value included.

**Deviations in  $\mu\text{m}$**  Table 3.20

**Outer ring**

D mm		$\Delta D_{mp}$		$V_{Dp}$	$V_{Dmp}$	$K_{Ea}$	$S_D$	$\Delta C_s$	
over	up to	high	low	max.	max.	max.	max.	high	low
<b>18</b> <sup>1)</sup>	<b>30</b>	0	-8	6	5	6	8	Identical with $\Delta B_s$ for the inner ring.	
<b>30</b>	<b>50</b>	0	-9	7	5	7	8		
<b>50</b>	<b>80</b>	0	-11	8	6	8	8		
<b>80</b>	<b>120</b>	0	-13	10	7	10	9		
<b>120</b>	<b>150</b>	0	-15	11	8	11	10		
<b>150</b>	<b>180</b>	0	-18	14	9	13	10		
<b>180</b>	<b>250</b>	0	-20	15	10	15	11		
<b>250</b>	<b>315</b>	0	-25	19	13	18	13		
<b>315</b>	<b>400</b>	0	-28	22	14	20	15		

1) This value included.



**Tolerance class P4**

Deviations in $\mu\text{m}$												
Inner ring												
d mm		$\Delta d_{mp}, \Delta d_s$		$V_{dp}$	$V_{dmp}$	$K_{ia}$	$S_d$	$S_{ia}$	$\Delta B_s$		$\Delta T_s$	
over	up to	high	low	max.	max.	max.	max.	max.	high	low	high	low
10 <sup>1)</sup>	18	0	-5	4	4	3	3	3	0	-200	+200	-200
18	30	0	-6	5	4	3	4	4	0	-200	+200	-200
30	50	0	-8	6	5	4	4	4	0	-240	+200	-200
50	80	0	-9	7	5	4	5	4	0	-300	+200	-200
80	120	0	-10	8	5	5	5	5	0	-400	+200	-200
120	180	0	-13	10	7	6	6	7	0	-500	+350	-250
180	250	0	-15	11	8	8	7	8	0	-600	+350	-250

Table 3.21

1) This value included.

Deviations in $\mu\text{m}$												
Outer ring												
D mm		$\Delta D_{mp}, \Delta D_s$		$V_{Dp}$	$V_{Dmp}$	$K_{ea}$	$S_D$	$S_{ea}$	$\Delta C_s$			
over	up to	high	low	max.	max.	max.	max.	max.	high	low		
<b>18<sup>1)</sup></b>	<b>30</b>	0	-6	5	4	4	4	5	Identical with $\Delta B_s$ for the inner ring.			
<b>30</b>	<b>50</b>	0	-7	5	5	5	4	5				
<b>50</b>	<b>80</b>	0	-9	7	5	5	4	5				
<b>80</b>	<b>120</b>	0	-10	8	5	6	5	6				
<b>120</b>	<b>150</b>	0	-11	8	6	7	5	7				
<b>150</b>	<b>180</b>	0	-13	10	7	8	5	8				
<b>180</b>	<b>250</b>	0	-15	11	8	10	7	10				
<b>250</b>	<b>315</b>	0	-18	14	9	11	8	10				
<b>315</b>	<b>400</b>	0	-20	15	10	13	10	13				

Table 3.22

1) This value included.

**Note:** Limit deviations of the diameter D<sub>i</sub> of the outer ring rib for bearings with ribs are in accordance with tolerance class h9.



**Tapered roller bearings, inch-metric sizes (AFBMA)**

Deviations in $\mu\text{m}$												Inner ring- $\Delta d_{mp}$		Table 3.23
Tolerances classes														
d mm		4		2		3		0		00				
over	up to	high	low	high	low	high	low	high	low	high	low			
-	<b>76,2</b>	+13	0	+13	0	+13	0	+13	0	+8	0			
<b>76,2</b>	<b>266,7</b>	+25	0	+25	0	+13	0	+13	0	+8	0			
<b>266,7</b>	<b>304,8</b>	+25	0	+25	0	+13	0	+13	0	-	-			

Deviations in $\mu\text{m}$												Outer ring- $\Delta D_{mp}$		Table 3.24
Tolerances classes														
D mm		4		2		3		0		00				
over	up to	high	low	high	low	high	low	high	low	high	low			
-	<b>266,7</b>	+25	0	+25	0	+13	0	+13	0	+8	0			
<b>266,7</b>	<b>304,8</b>	+25	0	+25	0	+13	0	+13	0	-	-			
<b>304,8</b>	<b>609,6</b>	+51	0	+51	0	+25	0	-	-	-	-			

Deviations in $\mu\text{m}$							Assembled bearing- $K_{ia}, K_{ea}$				
D mm		Tolerances classes									
over	up to	4	2	3	0	00					
		max.	max.	max.	max.	max.					
-	<b>266,7</b>	51	38	8	4	2					
<b>266,7</b>	<b>304,8</b>	51	38	8	4	-					
<b>304,8</b>	<b>609,6</b>	51	38	18	-	-					



**Tapered roller bearings, inch-metric sizes (AFBMA)**

Deviations in $\mu\text{m}$												Assembled bearing - $\Delta T_s$		Table 3.26
Tolerances classes														
d mm		4		2		3		0		00				
over	up to	high	low	high	low	high	low	high	low	high	low			
-	<b>101,6</b>	+203	-	+203	0	+203	-203	+203	-203	+203	-203			
<b>101,6</b>	<b>266,7</b>	+356	-254	+203	0	+203	-203	+203	-203	+203	-203			
<b>266,7</b>	<b>304,8</b>	+356	-254	+203	0	+203	-203	+203	-203	-	-			

Deviations in $\mu\text{m}$												Inner ring+rollers assembly, with outer ring gauge - $\Delta_{T1s}$		Table 3.27
Tolerances classes														
d mm		4		2		3		0		00				
over	up to	high	low	high	low	high	low	high	low	high	low			
-	<b>101,6</b>	+102	0	+102	0	+102	-102	+102	-102	+102	-102			
<b>101,6</b>	<b>304,8</b>	+152	-152	+102	0	+102	-102	+102	-102	+102	-102			

Deviations in $\mu\text{m}$												Outer ring with gauge inner ring assembly - $\Delta T_{2s}$		Table 3.28
Tolerances classes														
d mm		4		2		3		0		00				
over	up to	high	low	high	low	high	low	high	low	high	low			
-	<b>101,6</b>	+102	0	+102	0	+102	-102	+102	-102	+102	-102			
<b>101,6</b>	<b>304,8</b>	+203	-102	+102	0	+102	-102	+102	-102	+102	-102			

**Tapered bore bearings**

Deviations $\mu\text{m}$												Taper 1:12		Table 3.29
d mm		Normal tolerance class, P6						Tolerance class P5						
		$\Delta d_{mp}$		$Vd_p^{1)}$	$\Delta d_{1mp} - \Delta d_{mp/2}$		$\Delta d_{mp}$		$Vd_p^{1)}$	$\Delta d_{1mp} - \Delta d_{mp}$				
over	up to	high	low	max.	high	low	high	low	max.	high	low			
<b>18</b>	<b>30</b>	+21	0	13	+21	0	+13	0	13	+13	0			
<b>30</b>	<b>50</b>	+25	0	15	+25	0	+16	0	15	+16	0			
<b>50</b>	<b>80</b>	+30	0	19	+30	0	+19	0	19	+19	0			
<b>80</b>	<b>120</b>	+35	0	25	+35	0	+22	0	22	+22	0			
<b>120</b>	<b>180</b>	+40	0	31	+40	0	+25	0	25	+25	0			
<b>180</b>	<b>250</b>	+46	0	38	+46	0	+29	0	29	+29	0			
<b>250</b>	<b>315</b>	+52	0	44	+52	0	+32	0	32	+32	0			
<b>315</b>	<b>400</b>	+57	0	50	+57	0	+36	0	36	+36	0			

1) Applies in all single radial planes of the bore

Deviations in $\mu\text{m}$		Taper 1:30					Table 3.30	
d mm		Normal tolerance class						
		$\Delta d_{mp}$		$V_{dp}^{(1)}$	$\Delta d_{1mp} - \Delta d_{mp}$			
over	up to	high	low	max.	high	low		
<b>80</b>	<b>120</b>	+20	0	25	+40	0		
<b>120</b>	<b>180</b>	+25	0	31	+50	0		
<b>180</b>	<b>250</b>	+30	0	38	+55	0		
<b>250</b>	<b>315</b>	+35	0	44	+60	0		
<b>315</b>	<b>400</b>	+40	0	50	+65	0		

1) Applies in all singular planes

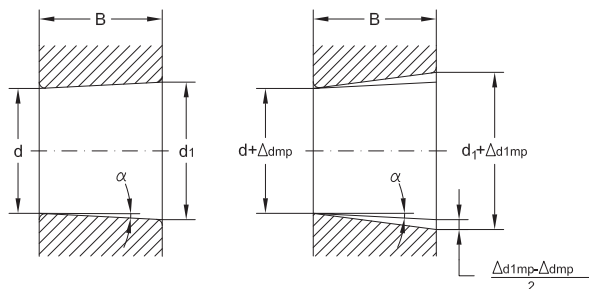

Tapered bore  
Half angle of taper,  $\alpha$

$\alpha = 2^{\circ}23'9,4''$  (taper 1:12)  
 $\alpha = 0^{\circ}57'17,4''$  (taper 1:30)

Nominal diameter,  $d$ , at the theoretical large end of bore

$$d_1 = d + \frac{1}{12} B \text{ (taper 1:12)}$$

$$d_1 = d + \frac{1}{30} B \text{ (taper 1:30)}$$

Deviations in $\mu\text{m}$		Shaft washer						Table 3.31	
d and $d_2$ mm		P0;P6;P5			P4;P2				
		$\Delta d_{mp}$	$\Delta d_{2mp}$	$V_{dp}$ $V_{d2p}$	$\Delta d_{mp}$ $\Delta d_{2mp}$		$V_{dp}$ $V_{d2p}$		
over	up to	high	low	max.	high	low	max.		
-	<b>18</b>	0	-8	6	0	-7	5		
<b>18</b>	<b>30</b>	0	-10	8	0	-8	6		
<b>30</b>	<b>50</b>	0	-12	9	0	-10	8		
<b>50</b>	<b>80</b>	0	-15	11	0	-12	9		
<b>80</b>	<b>120</b>	0	-20	15	0	-15	11		
<b>120</b>	<b>180</b>	0	-25	19	0	-18	14		
<b>180</b>	<b>250</b>	0	-30	23	0	-22	17		
<b>250</b>	<b>315</b>	0	-35	26	0	-25	19		
<b>315</b>	<b>400</b>	0	-40	30	0	-30	23		
<b>400</b>	<b>500</b>	0	-45	34	0	-35	26		
<b>500</b>	<b>630</b>	0	-50	38	0	-40	30		

Housing washer								
Deviations in $\mu\text{m}$								
D mm		P0;P6;P5			P4;P2			
		$\Delta D_{mp}$		$V_{Dp}$	$\Delta D_{mp}$		$V_{Dp}$	
over	up to	high	low	max.	high	low	max.	
10 <sup>1)</sup>	18	0	-11	8	0	-7	5	
18	30	0	-13	10	0	-8	6	
30	50	0	-16	12	0	-9	7	
50	80	0	-19	14	0	-11	8	
80	120	0	-22	17	0	-13	10	
120	180	0	-25	19	0	-15	11	
180	250	0	-30	23	0	-20	15	
250	315	0	-35	26	0	-25	19	
315	400	0	-40	30	0	-28	21	
400	500	0	-45	34	0	-33	25	
500	630	0	-50	38	0	-38	29	
630	800	0	-75	55	0	-45	34	

Table 3.32

1) This value included.

Variation of shaft washer and housing washer thickness							
Deviations in $\mu\text{m}$							
d* mm		$S_s$					$S_e$
		P0	P6	P5	P4	P2	P0,P6,P5,P4,P2
over	up to	max.	max.	max.	max.	max.	max.
-	18	10	5	3	2	1	Identical to $S_s$ for the shaft washer
18	30	10	5	3	2	1,2	
30	50	10	6	3	2	1,5	
50	80	10	7	4	3	2	
80	120	15	8	4	3	2	
120	180	15	9	5	4	3	
180	250	20	10	5	4	3	
250	315	25	13	7	5	4	
315	400	30	15	7	5	4	
400	500	30	18	9	6	-	
500	630	35	21	11	7	-	

Table 3.33

\* The values of  $S_s$  and  $S_e$  admitted for double direction thrust bearings are equal to the corresponding values of the single direction thrust bearings and are functions of the bore diameter d, of the single direction bearings.

### Assembled thrust bearings Bearing height

Deviations in $\mu\text{m}$					
d mm		$\Delta H_s$		$\Delta H_{2s}$	
over	up to	high	low	high	low
18	30	+20	-250	+150	-400
30	50	+20	-250	+150	-400
50	80	+20	-300	+150	-500
80	120	+25	-300	+200	-500
120	180	+25	-400	+200	-600
180	250	+30	-400	+250	-600
250	315	+40	-400	+350	-700
315	400	+40	-500	+350	-700
400	500	+50	-500	+400	-900
500	600	+60	-600	+500	-1100

Table 3.34

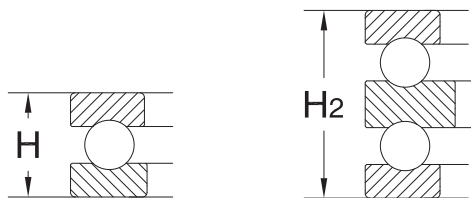

## Mounting chamfer dimensions tolerances

Symbols:

- $r_1, r_3$  - chamfer dimension in radial direction,
- $r_2, r_4$  - chamfer dimension in axial direction,
- $r_{s\ min}$  - general symbol for minimum limit of  $r_1, r_2, r_3, r_4$ ,
- $r_{1s\ max}, r_{3s\ max}$  - maximum dimension in radial direction,
- $r_{2s\ max}, r_{4s\ max}$  - maximum dimension in axial direction.

<b>Mounting chamfer dimension limits for radial and thrust bearings</b>					
Values in mm <span style="float: right;">Table 3.35</span>					
		Radial bearings		Thrust bearings	
$r_{s\ min}$	d		$r_{1s}, r_{3s}$	$r_{2s}, r_{4s}$	$r_{1s}, r_{2s}$
	over	up to	max.	max.	max.
<b>0,1</b>	-	-	0,2	0,4	0,2
<b>0,15</b>	-	-	0,3	0,6	0,3
<b>0,2</b>	-	-	0,5	0,8	0,5
<b>0,3</b>	-	40	0,6	1	0,8
	40	-	0,8	1	0,8
<b>0,6</b>	-	40	1	2	1,5
	40	-	1,3	2	1,5
<b>1</b>	-	50	1,5	3	2,2
	50	-	1,9	3	2,2
<b>1,1</b>	-	120	2	3,5	2,7
	120	-	2,5	4	2,7
<b>1,5</b>	-	120	2,3	4	3,5
	120	-	3	5	3,5
<b>2</b>	-	80	3	4,5	4
	80	220	3,5	5	4
	220	-	3,8	6	4
<b>2,1</b>	-	100	3,8	6	-
	-	280	4	6,5	4,5
<b>2,5</b>	100	280	4,5	6	-
	280	-	5	7	-
<b>3</b>	-	280	5	8	5,5
	280	-	5,5	8	5,5
<b>4</b>	-	-	6,5	9	6,5
<b>5</b>	-	-	8	10	8
<b>6</b>	-	-	10	13	10
7,5	-	-	12,5	17	12,5

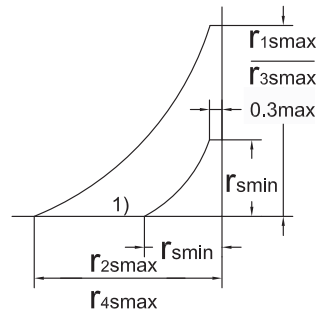
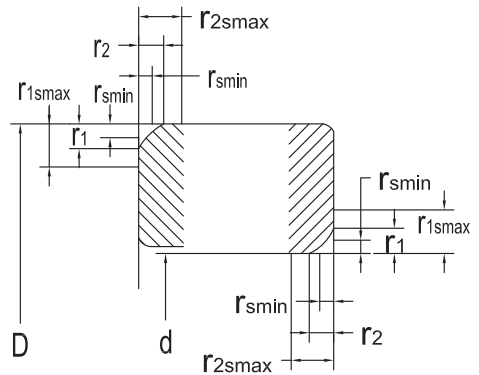
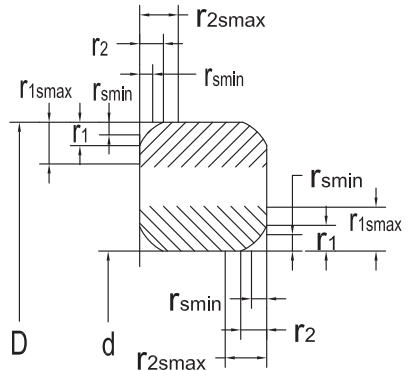

1) Only for  $d < 30$  mm



**Mounting chamfer dimension limits for tapered roller bearings**

Values in mm

Tab 3.36

$r_{smin}$	d, D		$r_{1s}, r_{3s}$	$r_{2s}, r_{4s}$
	over	incl.	max.	max.
<b>0,3</b>	-	40	0,7	1,4
	40	-	0,9	1,6
<b>0,6</b>	-	40	1,1	1,7
	40	-	1,3	2
<b>1</b>	-	50	1,6	2,5
	50	-	1,9	3
<b>1,5</b>	-	120	2,3	3
	120	250	2,8	3,5
	250	-	3,5	4
<b>2</b>	-	120	2,8	4
	120	250	3,5	4,5
	250	-	4	5
<b>2,5</b>	-	120	3,5	5
	120	250	4	5,5
	250	-	4,5	6
<b>3</b>	-	120	4	5,5
	120	250	4,5	6,5
	250	400	5	7
	400	-	5,5	7,5
<b>4</b>	-	120	5	7
	120	250	5,5	7,5
	250	400	6	8
	400	-	6,5	8,5
<b>5</b>	-	180	6,5	8
	180	-	7,5	9
<b>6</b>	-	180	7,5	10
	180	-	9	11

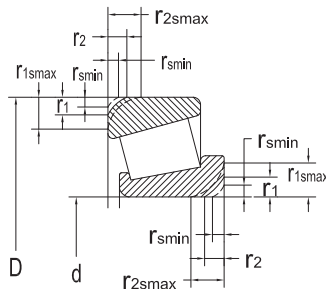

**Mounting chamfer dimension limits for tapered roller bearings**

Values in mm

(inch-metric sizes)

Table 3.37

Minimum values	Inner ring Nominal bore diameter		Maximum values		Outer ring Nominal outer diameter D		Maximum	
	d over	d up to	$r_{1smax}$	$r_{2smax}$	D over	D up to	$r_{3smax}$	$r_{4smax}$
<b>See bearing tables</b>	-	50,8	$r_{smin}+0,4$	$r_{smin}+0,9$	-	101,6	$r_{smin}+0,6$	$r_{smin}+1,1$
	50,8	101,6	$r_{smin}+0,5$	$r_{smin}+1,3$	101,6	168,3	$r_{smin}+0,6$	$r_{smin}+1,2$
	101,6	254	$r_{smin}+0,6$	$r_{smin}+1,8$	168,3	266,7	$r_{smin}+0,8$	$r_{smin}+1,4$
<b>1</b>	254	-	1,9	3	266,7	355,6	$r_{smin}+1,7$	$r_{smin}+1,7$
<b>1,5</b>	254	-	3,5	4	-	-	1,9	3
<b>2,5</b>	254	-	4,5	6	355,6	-	3,5	4
<b>3</b>	254	-	5,5	7,5	355,6	-	4,5	6
<b>3,3</b>	254	-	6,5	9	355,6	-	5,5	7,5
<b>3,5</b>	254	-	6,5	9	355,6	-	6,5	9
<b>6,4</b>	254	-	125	17	355,6	-	6,5	9
<b>8,5</b>	254	-	15	19	355,6	-	12,5	17

# Bearing applications

Radial and axial loads in bearing units can be transmitted by locating and non-locating bearings.

A locating bearing is generally used for medium and large-sized shafts that can reach high temperatures during operation. It has to support radially the shaft assembly and to locate it axially in both directions.

A non-locating bearing supports the shaft assembly only radially. It also allows axial displacement in relation to the housing to take place so that additional axial loading is avoided.

Axial displacement can take place either in the housing bore seating or in the bearing itself.

In case the shaft is supported by more than two bearings, only one of them will be a locating bearing and it will be the one with the lightest radial load.

In case of small-sized shafts, two non-locating bearings with limited displacement can be used. Each of them can accommodate axial loads in a single direction, having thus mutual location.

Fig. 4.1 shows a few of the most representative applications of locating and non-locating bearings, as follows:

a) The locating bearing is a single row deep groove ball bearing and the non-locating one is a cylindrical roller bearing with both rings tightly fitted on the shaft and into the housing, respectively.

b) Both bearings are supported by spherical roller bearings. The locating bearing is tightly fitted both on the shaft and into the housing. The non-locating bearing has the outer ring mounted with clearance into the housing and thus allows axial displacement in both directions.

c) The locating bearing consists of a cylindrical roller bearing, NUP type and the non-locating bearing consists of a cylindrical roller bearing, NU type.

d) The locating bearings consist of a cylindrical roller bearing, NU type which takes over radial loads and of a four-point contact ball bearing (unloaded on the outside). The non-locating bearing consists of a cylindrical roller bearing, NU type.

e) The locating bearings consist of a cylindrical

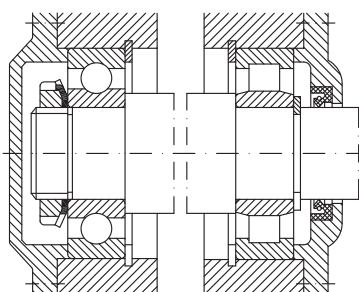

locating bearing a) non-locating bearing

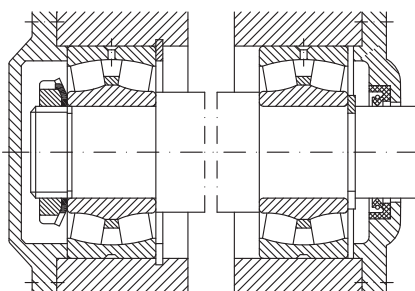

locating bearing b) non-locating bearing

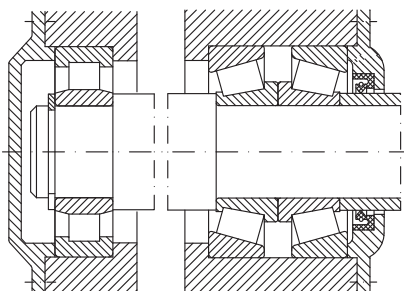

locating bearing c) non-locating bearing

Fig. 4.1

roller bearing, NU type which take over radial loads and of a four-point contact ball bearing (unloaded on the outside). The non-locating bearing consists of a cylindrical roller bearing, NU type.

f) The locating bearing consists of a needle roller



bearing, NA type which takes over radial loads and of a single row deep groove ball bearing (unloaded on the outside) which takes over axial loads in both directions. The non-locating bearing consists of a needle roller bearing, NA type.

g) The shaft bearings can also be X-type arrangement of two tapered roller bearings which can be considered mutual located bearing.

### Recommendation for bearing fit selection

Three main criteria have to be considered when selecting the bearing fit:

- Firm location and uniform support of bearings;
- Simply mounting and dismounting;
- Axial displacement of non-locating bearing.

The most common location is assured by tight fit.

A high tightening is recommended for roller bearings and large-sized bearings in comparison to ball bearings of the same size.

In case of a tight fit, the inner ring is supported by the entire shaft contact surface, thus bearing is used at full load carrying capacity.

The tolerance classes given in table 4.1 and 4.3 are available for bearing fits which do not exceed  $+120^\circ$  during operation.

As a general rule, selection of the tolerance class "H" is recommended for bearings of separable design and tolerance class "J" for bearings of non-separable design.

When selecting a fit, the load of rotating ring has to consider, namely:

- If the inner ring rotates and the load is stationary, the outer ring should be mounted with clearance fit.
- If the inner ring rotates and the load is stationary, the outer ring should be mounted with a tight fit.
- If the inner ring rotates and the direction of load is not determined, both rings should be mounted with a tight fit.

In table 4.1, there are given recommendations to select the tolerance class for shaft as function of: bearing type, loading and shaft diameter. In table 4.3, one can find recommendations to select the

tolerance class for housing,

Figure 4.2 shows schematically the tolerance classes for shaft and housing and their influence over fit type i.e. clearance, transition or tight fit for housing and transition fit or tight fit for shaft, respectively.

In tables 4.2 and 4.4, the deviations of the shaft diameter (4.2) and of the housing diameter (4.4) are given, considering the following:

- upper and lower limits
- theoretical minimum and maximum values of tightening (+) or clearance (0) in the fit.
- the minimum and maximum values of the probable tightening or clearance in the fit (99% of fits are between these limits).

The tolerances of bore diameter  $d_{mp}$  and outside diameter  $D_{mp}$  are valid for all metric sized bearings, except tapered roller bearings with  $d < 30$  mm and  $D < 150$  mm, (see table 3.15 and 3.16 on page 34 and table 3.31 and 3.32 on page 39-40).

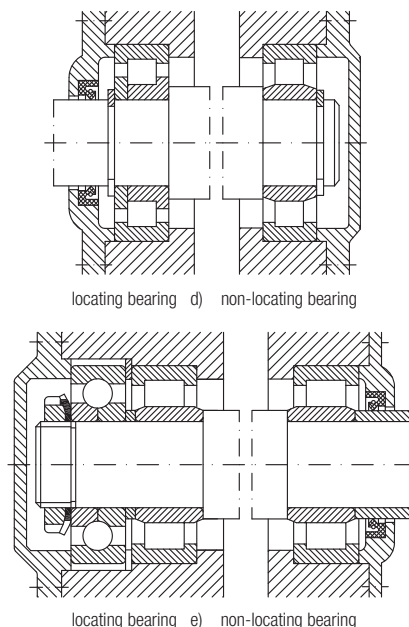



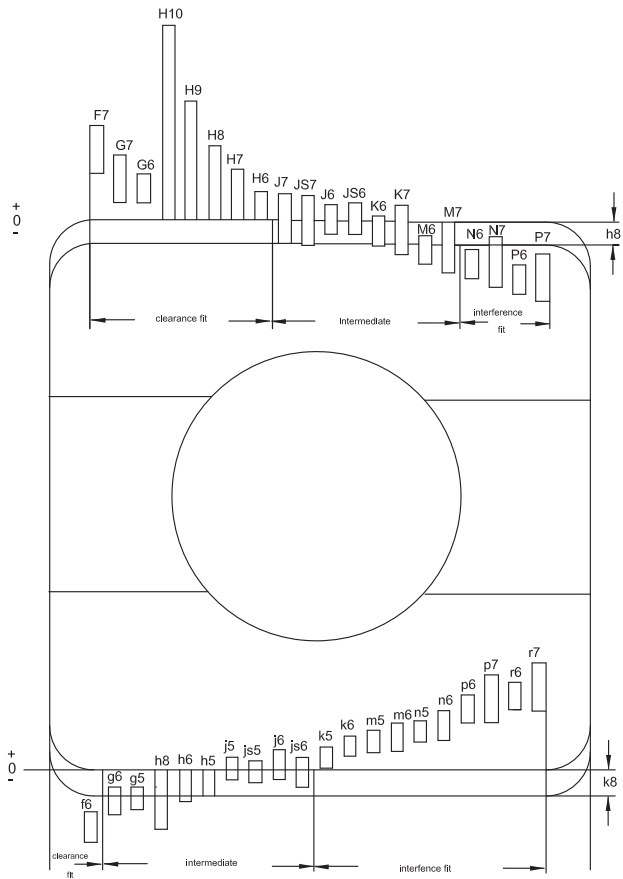
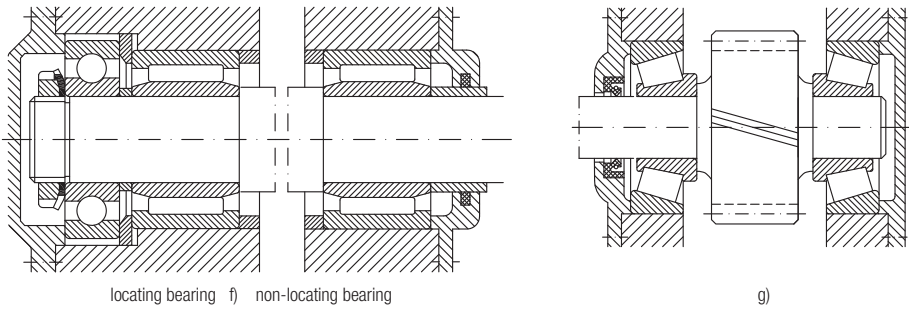
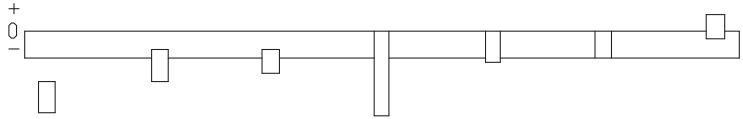

Fig. 4.2



<b>Bearing application</b>					
Tolerance classes for shafts <span style="float: right;">Table 4.1</span>					
Operating conditions	Examples	Shaft diameter [mm]			
		Ball bearings	Cylindrical needle and tapered roller bearings	Spherical roller bearings	Tolerance class symbol
<b>Radial bearings with cylindrical bore</b>					
<b>Stationary load on the inner ring</b>					
Easy axial displacement of inner ring on shaft desirable	Wheels on non-rotating shafts (free wheels)	All diameters			g6 (f6)
Axial displacement of inner ring on shaft not necessary	Tension pulleys, sheaves				h6
<b>Rotating inner ring load</b>					
Light and variable loads (P<0,06C)	Conveyers, lightly loaded mechanisms	18...100	≤40		j6
		>100...140	>40...100		k6
Normal and heavy loads (P>0,06C)	General mechanical engineering electric motors, turbines, pumps, gearboxes, woodworking machines	≤18	-	-	j5
		> 18...100	≤40	≤40	k5(k6)
		>100...140	>40...100	>40...65	m5(m6)
		>140...200	>100...140	>65...100	m6
		>200...280	>140...200	>100...140	n6
		-	>200...400	>140...280	p6
		-	-	>280...500	r6
		-	-	>500	r7
Heavy loads and shock loads, arduous working conditions (P>0,12C)	Heavy duty railway vehicles axle bearings, traction motors, rolling mills	-	>50...140	>50...100	n6
		-	>140...200	>100...200	p6
		-	>200	>200	r6
High running accuracy, light loads (P<0,06C)	Machine tools	≤18	-	-	h5
		> 18...100	≤40	-	j5
		>100...200	>40...140	-	k5
		-	>140...200	-	m5
<b>Axial loads</b>					
	All kind of bearing application	≤250	≤250	≤250	j6
		>250	>250	>250	js6
<b>Tapered bore bearings with withdrawal or adapter sleeve</b>					
	Axle shaft for railway vehicles General mechanical engineering	All diameters			h9 h10
<b>Thrust bearings</b>					
<b>Axial loads</b>					
Thrust ball bearings		All sizes			h6
Cylindrical and needle roller thrust bearings		All sizes			h6 (h8)
Cylindrical, needle roller and cage thrust assembly		All sizes			h8
<b>Combined loads spherical roller thrust bearings</b>					
Stationary load on shaft washer		≤250			j6
		>250			js6
Rotating load on shaft washer or undetermined load direction		≤200			k6
		> 200...400			m6
		>400			n8



Bearing application														Table 4.2			
Shaft fits																	
Shaft nominal diameter		Bearing Bore diameter tolerance		Deviations of shaft diameter, resultant fits Tolerances													
d		$\Delta d_{mp}$		f6	g6		g5		h8		h6		h5		j5		
over	up to	low	high	a) Deviations (shaft diameter) b) Tightening/Theoretical clearance c) Tightening/Probable clearance													
mm		$\mu\text{m}$															
1	3	-8	0	a) -6	-12	-2	-8	-2	-6	0	-14	0	-6	0	-4	+2	-2
				b) +2	-12	+6	-8	+6	-6	+8	-14	-8	-6	+8	-4	+10	0
				c) 0	-10	+4	-6	+5	-5	+6	-12	+6	-4	+7	-3	+9	-1
3	6	-8	0	-10	-18	-4	-12	-4	-9	0	-18	0	-8	0	-5	+3	-2
				-2	-18	+4	-12	+4	-9	+8	-18	+8	-8	+8	-5	+11	-2
				-4	-16	+2	-10	+3	-8	+5	-15	+6	-6	+7	-4	+10	-1
6	10	-8	0	-13	-22	-5	-14	-5	-11	0	-22	0	-9	0	-6	+4	-2
				-5	-22	+3	-14	+3	-11	+8	-22	+8	-9	+8	-6	+12	-2
				-7	-20	+1	-12	+1	-9	+5	-19	+6	-7	+6	-4	+10	0
10	18	-8	0	-16	-27	-6	-17	-6	-14	0	-27	0	-11	0	-8	+5	-3
				-8	-27	+2	-17	+2	-14	+8	-27	+8	-11	+8	-8	+13	-3
				-10	-25	0	-15	0	-12	+5	-24	+6	-9	+6	-6	+11	-1
18	30	-10	0	-20	-33	-7	-20	-7	-16	0	-33	0	-13	0	-9	+5	-4
				-10	-33	+3	-20	+3	-16	+10	-33	+10	-13	+10	-9	+15	-4
				-13	-30	0	-17	+1	-14	+6	-29	+7	-10	+8	-7	+13	-2
30	50	-12	0	-25	-41	-9	-25	-9	-20	0	-39	0	-16	0	-11	+6	-5
				-13	-41	+3	-25	+3	-20	+12	-39	+12	-16	+12	-11	+18	-5
				-17	-37	-1	-21	0	-17	+7	-34	+8	-12	+9	-8	+15	-2
50	80	-15	0	-30	-49	-10	-29	-10	-23	0	-46	0	-19	0	-13	+6	-7
				-15	-49	+5	-29	+5	-23	+15	-46	+15	-19	+15	-13	+21	-7
				-19	-45	+1	-25	+1	-19	+9	-40	+11	-15	+11	-9	+17	-3
80	120	-20	0	-36	-58	-12	-34	-12	-27	0	-54	0	-22	0	-15	+6	-9
				-16	-58	+8	-34	+8	-27	+20	-54	+20	-22	+20	-15	+26	-9
				-22	-52	+2	-28	+3	-22	-12	-46	+14	-16	+15	-10	+21	-4
120	180	-25	0	-43	-68	-14	-39	-14	-32	0	-63	0	-25	0	-18	+7	-11
				-18	-68	+11	-39	+11	-32	+25	-63	+25	-25	+25	-18	+32	-11
				-25	-61	+4	-32	+5	-26	+15	-53	+18	-18	+19	-12	+26	-5
180	250	-30	0	-50	-79	-15	-44	-15	-35	0	-72	0	-29	0	-20	+7	-13
				-20	-79	+15	-44	+15	-35	+30	-72	+30	-29	+30	-20	+37	-13
				-28	-71	+7	-36	+9	-29	+18	-60	+22	-21	+24	-14	+31	-7
250	315	-35	0	-56	-88	-17	-49	-17	-40	0	-81	0	-32	0	-23	+7	-16
				-21	-88	+18	-49	+18	-40	+35	-81	+35	-32	+35	-23	+42	-16
				-30	-79	+9	-40	+10	-32	+22	-68	+26	-23	+27	-15	+34	-8
315	400	-40	0	-62	-98	-18	-54	-18	-43	0	-89	0	-36	0	-25	+7	-18
				-22	-98	+22	-54	+22	-43	+40	-89	+40	-36	+40	-25	+47	-18
				-33	-87	+11	-43	+14	-35	+25	-74	+29	-25	+32	-17	+39	-10

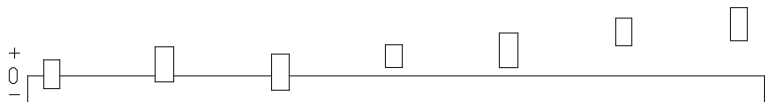

**Bearing application**  
**Shaft fits** Table 4.2 (continued)

Shaft nominal diameter		Bearing Bore diameter tolerance		Deviations of shaft diameter, resultant fits Tolerances													
d		Δd <sub>mp</sub>		js5	j6	js6	k5	k6	m5	m6							
over	up to	low	high	a) Deviations (shaft diameter) b) Tightening/Theoretical clearance c) Tightening/Probable clearance													
mm		μm															
1	3	-8	0	a) +2	-2	+4	-2	+3	-3	+4	0	+6	0	+6	+2	+8	+2
				b) +10	-2	+12	-2	+11	-3	+12	0	+14	0	+14	+2	+16	+2
				c) +9	-1	+10	0	+9	-1	+11	+1	+12	+2	+13	+3	+14	+4
3	6	-8	0	+2,5	-2,5	+6	-2	+4	-4	+6	+1	+9	+1	+9	+4	+12	+4
				+10,5	-2,5	+14	-2	+12	-4	+14	+1	+17	+1	+17	+4	+20	+4
				+9	-1	+12	0	+10	-2	+13	+2	+15	+3	+16	+5	+18	+6
6	10	-8	0	+3	-3	+7	-2	+4,5	-4,5	+7	+1	+10	+1	+12	+6	+15	+6
				+11	-3	+15	-2	+12,5	-4,5	+15	+1	+18	+1	+20	+6	+23	+6
				+9	-1	+13	0	+11	-3	+13	+3	+16	+3	+18	+8	+21	+8
10	18	-8	0	+4	-4	+8	-3	+5,5	-5,5	+9	+1	+12	+1	+15	+7	+18	+7
				+12	-4	+16	-3	+13,5	-5,5	+17	+1	+20	+1	+23	+7	+26	+7
				+10	-2	+14	-1	+11	-3	+15	+3	+18	+3	+21	+9	+24	+9
18	30	-10	0	+4,5	-4,5	+9	-4	+6,5	-6,5	+11	+2	+15	+2	+17	+8	+21	+8
				+14,5	-4,5	+19	-4	+16,5	-6,5	+21	+2	+25	+2	+27	+8	+31	+8
				+12	-2	+16	-1	+14	-4	+19	+4	+22	+5	+25	+10	+28	+11
30	50	-12	0	+5,5	-5,5	+11	-5	+8	-8	+13	+2	+18	+2	+20	+9	+25	+9
				+17,5	-5,5	+23	-5	+20	-8	+25	+2	+30	+2	+32	+9	+37	+9
				+15	-3	+19	-1	+16	-4	+22	+5	+26	+6	+29	+12	+33	+13
50	80	-15	0	+6,5	-6,5	+12	-7	+9,5	-9,5	+15	+2	+21	+2	+24	+11	+30	+11
				+21,5	-6,5	+27	-7	+24,5	-9,5	+30	+2	+36	+2	+39	+11	+45	+11
				+18	-3	+23	-3	+20	-5	+26	+6	+32	+6	+35	+15	+41	+15
80	120	-20	0	+7,5	-7,5	+13	-9	+11	-11	+18	+3	+25	+3	+28	+13	+35	+13
				+27,5	-7,5	+33	-9	+31	-11	+38	+3	+45	+3	+48	+13	+55	+13
				+23	-3	+27	-3	+25	-5	+33	+8	+39	+9	+43	+18	+49	+19
120	180	-25	0	+9	-9	+14	-11	+12,5	-12,5	+21	+3	+28	+3	+33	+15	+40	+15
				+34	-9	+39	-11	37,5	-12,5	+46	+3	+53	+3	+58	+15	+65	+15
				+28	-3	+32	-4	+31	-6	+40	+9	+46	+10	+52	+21	+58	+22
180	250	-30	0	+10	-10	+16	-13	+14,5	-14,5	+24	+4	+33	+4	+37	+17	+46	+17
				+40	-10	+46	-13	+44,5	-14,5	+54	+4	+63	+4	+67	+17	+76	+17
				+34	-4	+38	-5	+36	-6	+48	+10	+55	+12	+61	+23	+68	+25
250	315	-35	0	+11,5	-11,5	+16	-16	+16	-16	+27	+4	+36	+4	+43	+20	+52	+20
				+46,5	-11,5	+51	-16	+51	-16	+62	+4	+71	+4	+78	+20	+87	+20
				+39	-4	+42	-7	+42	-7	+54	+12	+62	+13	+70	+28	+78	+29
315	400	-40	0	+12,5	-12,5	+18	-18	+18	-18	+29	+4	+40	+4	+46	+21	+57	+21
				+52,5	-12,5	+58	-18	+58	-18	+69	+4	+80	+4	+89	+21	+97	+21
				+44	-4	+47	-7	+47	-7	+61	+12	+69	+15	+78	+29	+86	+32



**Bearing application**
**Shaft fits**

Table 4.2. (continued)

Shaft nominal diameter		Bearing Bore diameter tolerance		Deviations of shaft diameter, resultant fits Tolerances											
d		$\Delta d_{mp}$		n5	n6	p6	p7	r6	r7						
over	up to	low	high	a) Deviations (shaft diameter) b) Tightening/Theoretical clearance c) Tightening/Probable clearance											
mm		$\mu m$													
1	3	-8	0	a) +8	+4	+10	+4	+12	+6	+16	+6	+16	+10	+20	+10
				b) +16	+4	+18	+4	+20	+6	+24	+6	+24	+10	+28	+10
				c) +15	+5	+16	+6	+18	+8	+22	+8	+22	+12	+26	+12
3	6	-8	0	+13	+8	+16	+8	+20	+12	+24	+12	+23	+15	+27	+15
				+21	+8	+24	+8	+28	+12	+32	+12	+31	+15	+35	+15
				+20	+9	+22	+10	+26	+14	+30	+14	+29	+17	+33	+17
6	10	-8	0	+16	+10	+19	+10	+24	+15	+30	+15	+28	+19	+34	+19
				+24	+10	+27	+10	+32	+15	+38	+15	+36	+19	+42	+19
				+22	+12	+25	+12	+30	+17	+35	+18	+34	+21	+39	+22
10	18	-8	0	+20	+12	+23	+12	+29	+18	+36	+18	+34	+23	+41	+23
				+28	+12	+31	+12	+37	+18	+44	+18	+42	+23	+49	+23
				+26	+14	+29	+14	+35	+20	+41	+21	+40	+25	+46	+26
18	30	-10	0	+24	+15	+28	+15	+35	+22	+43	+22	+41	+28	+49	+28
				+34	+15	+38	+15	+45	+22	+53	+22	+51	+28	+59	+28
				+32	+17	+35	+18	+42	+25	+50	+25	+48	+31	+56	+31
30	50	-12	0	+28	+17	+33	+17	+42	+26	+51	+26	+50	+34	+59	+34
				+40	+17	+45	+17	+54	+26	+63	+26	+62	+34	+71	+34
				+37	+20	+41	+21	+50	+30	+59	+30	+58	+38	+67	+38
50	65	-15	0	+33	+20	+39	+20	+51	+32	+62	+32	+60	+41	+71	+41
				+48	+20	+54	+20	+66	+32	+77	+32	+75	+41	+86	+41
				+44	+24	+50	+24	+62	+36	+72	+37	+71	+45	+81	+46
65	80	-15	0	+33	+20	+39	+20	+51	+32	+62	+32	+62	+43	+73	+43
				+48	+20	+54	+20	+66	+32	+77	+32	+77	+43	+88	+43
				+44	+24	+50	+24	+62	+36	+72	+37	+73	+47	+83	+48
80	100	-20	0	+38	+23	+45	+23	+59	+37	+72	+37	+73	+51	+86	+51
				+58	+23	+65	+23	+79	+37	+92	+37	+93	+51	+106	+51
				+53	+28	+59	+29	+73	+43	+85	+44	+87	+57	+99	+58
100	120	-20	0	+38	+23	+45	+23	+59	+37	+72	+37	+76	+54	+89	+54
				+58	+23	+65	+23	+79	+37	+92	+37	+96	+54	+109	+54
				+53	+28	+59	+29	+73	+43	+85	+44	+90	+60	+102	+61
120	140	-25	0	+45	+27	+52	+27	+68	+43	+83	+43	+88	+63	+103	+63
				+70	+27	+77	+27	+93	+43	+108	+43	+113	+63	+128	+63
				+64	+33	+70	+34	+86	+50	+100	+51	+106	+70	+120	+71
140	160	-25	0	+45	+27	+52	+27	+68	+43	+83	+43	+90	+65	+105	+65
				+70	+27	+77	+27	+93	+43	+108	+43	+115	+65	+130	+65
				+64	+33	+70	+34	+86	+50	+100	+51	+108	+72	+122	+73
160	180	-25	0	+45	+27	+52	+27	+68	+43	+83	+43	+93	+68	+108	+68
				+70	+27	+77	+27	+93	+43	+108	+43	+118	+68	+133	+68
				+64	+33	+70	+34	+86	+50	+100	+51	+111	+75	+125	+76

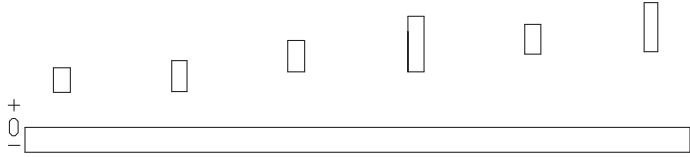
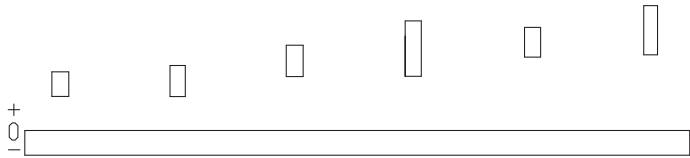

**Bearing application  
Shaft fits**

Table 4.2 (continued)

Shaft nominal diameter		Bearing Bore diameter tolerance		Deviations of shaft diameter, resultant fits Tolerances											
d		$\Delta d_{mp}$		n5	n6	p6	p7	r6	r7						
over	up to	low	high	a) Deviations (shaft diameter) b) Tightening/Theoretical clearance c) Tightening/Probable clearance											
mm		$\mu\text{m}$													
180	200	-30	0	a)+51	+31	+60	+31	+79	+50	+96	+50	+106	+77	+123	+77
				b)+81	+31	+90	+31	+109	+50	+126	+50	+136	+77	+153	+77
				c)+75	+37	+82	+39	+101	+58	+116	+60	+128	+85	+143	+87
200	225	-30	0	+51	+31	+60	+31	+79	+50	+96	+50	+109	+80	+126	+80
				+81	+31	+90	+31	+109	+50	+126	+50	+139	+80	+156	+80
				+75	+37	+82	+39	+101	+58	+116	+60	+131	+88	+146	+90
225	250	-30	0	+51	+31	+60	+31	+79	+50	+96	+50	+113	+84	+130	+84
				+81	+31	+90	+31	+109	+50	+126	+50	+143	+84	+160	+84
				+75	+37	+82	+39	+101	+58	+116	+60	+135	+92	+150	+94
250	280	-35	0	+57	+34	+66	+34	+88	+56	+108	+56	+126	+94	+146	+94
				+92	+34	+101	+34	+123	+56	+143	+56	+161	+94	+181	+94
				+84	+42	+92	+43	+114	+65	+131	+68	+152	+103	+169	+106
280	315	-35	0	+57	+34	+66	+34	+88	+56	+108	+56	+130	+98	+150	+98
				+92	+34	+101	+34	+123	+56	+143	+56	+165	+98	+185	+98
				+84	+42	+92	+43	+114	+65	+131	+68	+156	+107	+173	+110
315	355	-40	0	+62	+37	+73	+37	+98	+62	+119	+62	+144	+108	+165	+108
				+102	+37	+113	+37	+138	+62	+159	+62	+184	+108	+205	+108
				+94	+45	+102	+48	+127	+73	+146	+75	+173	+119	+192	+121
355	400	-40	0	+62	+37	+73	+37	+98	+62	+119	+62	+150	+114	+171	+114
				+102	+37	+113	+37	+138	+62	+156	+62	+190	+114	+211	+114
				+94	+45	+102	+48	+127	+73	+146	+75	+179	+125	+198	+127

**Bearing application**

 Tolerance classes for housing bores  
 Radial bearings

Table 4.3

<b>Solid housing Operating conditions</b>	<b>Examples</b>	<b>Tolerance class symbol</b>	<b>Outer ring displacement</b>
<b>Rotating outer ring load</b>			
Heavy loads on bearings in thin-walled housings, heavy shock loads ( $P > 0,12 C$ )	Roller bearing wheel hubs, connecting rod bearings	P7	Outer ring cannot be displaced
Normal and heavy loads ( $P > 0,06 C$ )	Ball bearing wheel hubs, connecting rod bearings, crane traveling wheels	N7	
Light and variable loads ( $P \leq 0,06 C$ )	Conveyor rollers, rope sheaves, belt tension pulleys	M7	
<b>Direction of load indeterminate</b>			
Heavy shock loads	Traction motors	M7	Outer ring cannot be displaced
Normal and heavy loads ( $P > 0,06 C$ ) Outer ring displacement is not necessary	Electric motors, pumps, crankshaft main bearings	K7	

<b>Split or solid housing Operating conditions</b>	<b>Examples</b>	<b>Tolerance class symbol</b>	<b>Outer ring displacement</b>
<b>Direction of load indeterminate</b>			
Light and normal loads Desirable outer ring displacement ( $P \leq 0,12 C$ )	Medium-sized electric motors, pumps, crankshaft main bearings	J7	Outer ring cannot be displaced
<b>Stationery outer ring load</b>			
All kind of loads	General mechanical engineering, railway axleboxes	H7	Outer ring can be easily displaced
Light and normal loads with simple conditions ( $P \leq 0,12 C$ )		H8	
Heat conduction through shaft	Drying cylinders, large electrical machines with spherical roller bearings	G7	



**Bearing application**  
**Tolerance classes for housing bores**  
**Radial bearings**

Table 4.3 (continued)

<b>Split housing</b> <b>Operating conditions</b>	<b>Examples</b>	<b>Tolerance class symbol</b>	<b>Outer ring displacement</b>	
High accuracy rotation, quiet running				
High stiffness at variable loads	Main shafts for machine-tools with roller bearings	D ≤ 125 D > 125	M6 N6	The outer ring cannot be displaced.
Light loads, indeterminate load direction	Shaft operating surface for grinding machines with ball bearing, free bearing for high speed superchargers	K6		The outer ring cannot be displaced.
Desirable outer ring displacement	Shaft operating surface for grinding machines with ball bearing, free bearing for high speed superchargers	J6		The outer ring can be displaced.
Quiet running	Small-sized electrical machines	H6		The outer ring can be easily displaced

**Tolerance classes for housing bores**  
**Thrust bearings**

Table 4.3 (continued)

<b>Thrust bearings</b> <b>Operating conditions</b>	<b>Tolerance class symbol</b>	<b>Outer ring displacement</b>
<b>Axial load</b>		
Thrust ball bearings Cylindrical and needle roller thrust bearings	H8 H7 (H9)	For less accurate bearing arrangements, radial clearance in housing can be up to 0,001 D
<b>Combined loads on spherical roller thrust bearings</b>		
Local load on housing washer Peripheral load on housing washer	H7 (H9) M7	
<b>Axial or combined load on spherical roller thrust bearings</b>		
Bearing radial location is ensured by another bearing	-	Housing washer fitted with clearance up to 0,001 D



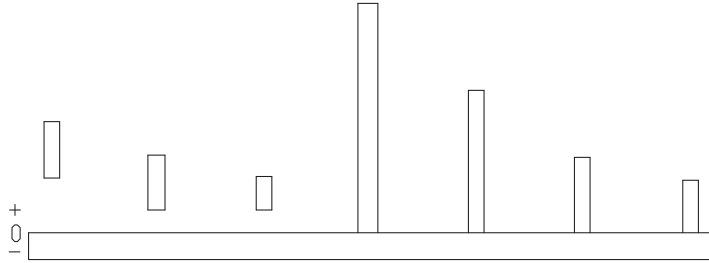

**Bearing application  
Housing fits**

Table 4.4

Housing nominal diameter		Bearing Outside diameter tolerance		Deviations of housing bore diameter, resultant fits Tolerances																																									
D		$\Delta d_{mp}$		F7			G7			G6			H10		H9		H8		H7																										
over	up to	low	high	a) Deviations (shaft diameter) b) Tightening/Theoretical clearance c) Tightening/Probable clearance																																									
mm		$\mu m$																																											
6	10	-8	0	a) +13	+28	+5	+20	+5	+14	0	+58	0	+36	0	+22	0	+15	b) -13	-36	-5	-28	-5	-22	0	-66	0	-44	0	-30	0	-23	c) -16	-33	-8	-25	-7	-20	-3	-63	-3	-41	-3	-27	-3	-20
				+16	+34	+6	+24	+6	+17	0	+70	0	+43	0	+27	0	+18	-16	-42	-6	-32	-6	-25	0	-78	0	-51	0	-35	0	-26	-19	-39	-9	-29	-8	-23	-3	-75	-3	-48	-3	-32	-3	-23
				+20	+41	+7	+28	+7	+20	0	+84	0	+52	0	+33	0	+21	-20	-50	-7	-37	-7	-29	0	-93	0	-61	0	-42	0	-30	-23	-47	-10	-34	-10	-26	-4	-89	-4	-57	-3	-39	-3	-27
10	18	-8	0	+25	+50	-9	+34	+9	+25	0	+100	0	+62	0	+39	0	+25	-25	-61	-9	-45	-9	-36	0	-111	0	-73	0	-50	0	-36	-29	-57	-13	-41	-12	-33	-5	-106	-5	-68	-4	-46	-4	-32
				+30	+60	+10	+40	+10	+29	0	+120	0	+74	0	+46	0	+30	-30	-73	-10	-53	-10	-42	0	-133	0	-87	0	-59	0	-43	-35	-68	-15	-48	-14	-38	-6	-127	-5	-82	-5	-54	-5	-38
				+36	+71	+12	+47	+12	+34	0	+140	0	+87	0	+54	0	+35	-36	-86	-12	-62	-12	-49	0	-155	0	-102	0	-69	0	-50	-41	-81	-17	-57	-17	-44	-7	-148	-6	-96	-6	-63	-5	-45
120	150	-18	0	+43	+83	+14	+54	+14	+39	0	+160	0	+100	0	+63	0	+40	-43	-101	-14	-72	-14	-57	0	-178	0	-118	0	-81	0	-58	-50	-94	-21	-65	-20	-51	-8	-170	-8	-110	-7	-74	-7	-51
				+43	+83	+14	+54	+14	+39	0	+160	0	+100	0	+63	0	+40	-43	-108	-14	-79	-14	-64	0	-185	0	-125	0	+88	0	-65	-51	-100	-22	-71	-21	-57	-11	-174	-10	-115	-10	-78	-8	-57
				+50	+96	+15	+61	+15	+44	0	+185	0	+115	0	+72	0	+46	-50	-126	-15	-91	-15	-74	0	-215	0	-145	0	-102	0	-76	-60	-116	-25	-81	-23	-66	-13	-202	-13	-132	-12	-90	-10	-66
180	250	-30	0	+56	+108	-17	+69	+17	+49	0	+210	0	+130	0	+81	0	+52	-56	-143	-17	-104	-17	-84	0	-245	0	-165	0	-116	0	-87	-68	-131	-29	-92	-26	-75	-16	-229	-15	-150	-13	-103	-12	-75
				+62	+119	+18	+75	+18	+54	0	+230	0	+140	0	+89	0	+57	-62	-159	-18	-115	-18	-94	0	-270	0	-180	0	-129	0	-97	-75	-146	-31	-102	-29	-83	-18	-252	-17	-163	-15	-114	-13	-84
				+68	+131	+20	+83	+20	+60	0	+250	0	+155	0	+97	0	+63	-68	-176	-20	-128	-20	-105	0	-295	0	-200	0	-142	0	-108	-83	-161	-35	-113	-32	-93	-20	-275	-19	-181	-17	-125	-15	-93

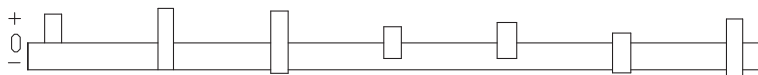

**Bearing application Housing fits** Table 4.4 (continued)

Housing nominal diameter		Bearing Outside diameter tolerance		Deviations of housing bore diameter, resultant fits Tolerances													
D		$\Delta d_{mp}$		H6	J7	JS7	J6	JS6	K6	K7							
over	up to	low	high	a) Deviations (shaft diameter) b) Tightening/Theoretical clearance c) Tightening/Probable clearance													
mm		$\mu m$															
6	10	-8	0	a)0	+9	-7	+8	-7,5	+7,5	-4	+5	-4,5	+4,5	-7	+2	-10	+5
				b)0	-17	+7	+16	+7,5	-15,5	+4	-13	+4,5	-12,5	+7	-10	+10	-13
				c)-2	-15	+4	-13	+5	-13	+2	-11	+3	-11	+5	-8	+7	-10
10	18	-8	0	0	+11	-8	+10	-9	+9	-5	+6	-5,5	+5,5	-9	+2	-12	+6
				0	-19	+8	-18	+9	-17	+5	-14	+5,5	-13,5	+9	-10	+12	-14
				-2	-17	+5	-15	+6	-14	+3	-12	+3	-11	+7	-8	+9	-11
18	30	-9	0	0	+13	-9	+12	-10,5	+10,5	-5	+8	-6,5	+6,5	-11	+2	-15	+6
				0	-22	+9	-21	+10,5	-19,5	+5	-17	+6,5	-15,5	+11	-11	+15	-15
				-3	-19	+6	-18	+7	-16	+2	-14	+4	-13	+8	-8	+12	-12
30	50	-11	0	0	+16	-11	+14	-12,5	+12,5	-6	+10	-8	+8	-13	+3	-18	+7
				0	-27	+11	-25	-12,5	-23,5	+6	-21	+8	-19	+13	-14	+18	-18
				-3	-24	+7	-21	+9	-20	+3	-18	+5	-16	+10	-11	+14	-14
50	80	-13	0	0	+19	-12	+18	-15	+15	-6	+13	-9,5	+9,5	-15	+4	-21	+9
				0	-32	+12	-31	+15	-28	+6	-26	+9,5	-22,5	+15	-17	+21	-22
				-4	-28	+7	-26	+10	-23	+2	-22	+6	-19	+11	-13	+16	-17
80	120	-15	0	0	+22	-13	+22	-17,5	+17,5	-6	+16	-11	+11	-18	+4	-25	+10
				0	-37	+13	-37	+17,5	-32,5	+6	-31	+11	-26	+18	-19	+25	-25
				-5	-32	+8	-32	+12	-27	+1	-26	+6	-21	+13	-14	+20	-20
120	150	-18	0	0	+25	-14	+26	-20	+20	-7	+18	-12,5	+12,5	-21	+4	-28	+12
				0	-43	+14	-44	+20	-38	+7	-36	+12,5	-30,5	+21	-22	+28	-30
				-6	-37	+7	-37	+13	-31	+1	-30	+7	-25	+15	-16	+21	-23
150	180	-25	0	0	+25	-14	+26	-20	+20	-7	+18	-12,5	+12,5	-21	+4	-28	+12
				0	-50	+14	-51	+20	-45	+7	-43	+2,5	-37,5	+21	-29	+28	-37
				-7	-43	+6	-43	+12	-37	0	-36	+6	-31	+14	-22	+20	-29
180	250	-30	0	0	+29	-16	+30	-23	+23	-7	+22	-14,5	+14,5	-24	+5	-33	+13
				0	-59	+16	-60	+23	-53	+7	-52	+14,5	-44,5	+24	-35	+33	-43
				-8	-51	+6	-50	+13	-43	-1	-44	+6	-36	+16	-27	+23	-33
250	315	-35	0	0	+32	-16	+36	-26	+26	-7	+25	-16	+16	-27	+5	-36	+16
				0	-67	+16	-71	+26	-61	+7	-60	+16	+51	+27	-40	+36	-51
				-9	-58	+4	-59	+14	-49	-2	-51	+7	-42	+18	-31	+24	-39
315	400	-40	0	0	+36	-18	+39	-28,5	+28,5	-7	+29	-18	+18	-29	+7	-40	+17
				0	-76	+18	-79	+28,5	-68,5	+7	-69	+18	-58	+29	-47	+40	-57
				-11	-65	+5	-66	+15	-55	-4	-58	+7	-47	+18	-36	+27	-44
400	500	-45	0	0	+40	-20	+43	-31,5	+31,5	-7	+33	-20	+20	-32	+8	-45	+18
				0	-85	+20	-88	+31,5	-76,5	+7	-78	+20	-65	+32	-53	+45	-63
				-12	-73	+5	-73	+17	-62	-5	-66	+8	-53	+20	-41	+30	-48

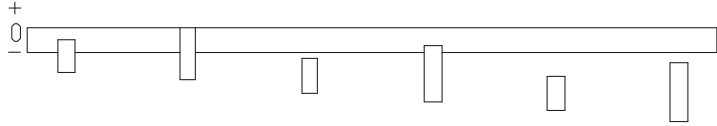

**Bearing application  
Housing fits**

Table 4.4 (continued)

Housing nominal diameter		Bearing Outside diameter tolerance		Deviations of housing bore diameter, resultant fits Tolerances											
D		$\Delta d_{mp}$		M6	M7	N6	N7	P6	P7						
over	up to	low	high	a) Deviations (shaft diameter) b) Tightening/Theoretical clearance c) Tightening/Probable clearance											
mm		$\mu m$													
6	10	-8	0	a)-12	-3	-15	0	-16	-7	-19	-4	-21	-12	-24	-9
				b)+12	-5	+15	-8	+16	-1	+19	-4	+21	+4	+24	+1
				c)+10	-3	+12	-5	+14	+1	+16	-1	+19	+6	+21	+4
10	18	-8	0	-15	-4	-18	0	-20	-9	-23	-5	-26	-15	-29	-11
				+15	-4	+18	-8	+20	+1	+23	-3	+26	+7	+29	+3
				+13	-2	+15	-5	+18	+3	+20	0	+24	+9	+26	+6
18	30	-9	0	-17	-4	-21	0	-24	-11	-28	-7	-31	-18	-35	-14
				+17	-5	+21	-9	+24	+2	+28	-2	+31	+9	+35	+5
				+14	-2	-18	-6	+21	+5	+25	+1	+28	+12	+32	+8
30	50	-11	0	-20	-4	-25	0	-28	-12	-33	-8	-37	-21	-42	-17
				+20	-7	+25	-11	+28	+1	+33	-3	+37	+10	+42	+6
				+17	-4	+21	-7	+25	+4	+29	+1	+34	+13	+38	+10
50	80	-13	0	-24	-5	-30	0	-33	-14	-39	-9	-45	-26	-51	-21
				+24	-8	+30	-13	+33	+1	+39	-4	+45	+13	+51	+8
				+20	-4	+25	-8	+29	+5	+34	+1	+41	+17	+46	+13
80	120	-15	0	-28	-6	-35	0	-38	-16	-45	-10	-52	-30	-59	-24
				+28	-9	+35	-15	+38	+1	+45	-5	+52	+15	+59	+9
				+23	-4	+30	-10	+33	+6	+40	0	+47	+20	+54	+14
120	150	-18	0	-33	-8	-40	0	-45	-20	-52	-12	-61	-36	-68	-28
				+33	-10	+40	-18	+45	+2	+52	-6	+61	+18	+68	+10
				+27	-4	+33	-11	+39	+8	+45	+1	+55	+24	+61	+17
150	180	-25	0	-33	-8	-40	0	-45	-20	-52	-12	-61	-36	-68	-28
				+33	-17	+40	-25	+45	-5	+52	-13	+61	+11	+68	+3
				+26	-10	+32	-17	+38	+2	+44	-5	+54	+18	+60	+11
180	250	-30	0	-37	-8	-46	0	-51	-22	-60	-14	-70	-41	-79	-33
				+37	-22	+46	-30	+51	-8	+60	-16	+70	+11	+79	+3
				+29	-14	+36	-20	+43	0	+50	-6	+62	+19	+69	+13
250	315	-35	0	-41	-9	-52	0	-57	-25	-66	-14	-79	-47	-88	-36
				+41	-26	+52	-35	+57	-10	+66	-21	+79	+12	+88	+1
				+32	-17	+40	-23	+48	-1	+54	-9	+70	+21	+76	+13
315	400	-40	0	-46	-10	-57	0	-62	-26	-73	-16	-87	-51	-98	-41
				+46	-30	+57	-40	+62	-14	+73	-24	+87	+11	+98	+1
				+35	-19	+44	-27	+51	-3	+60	-11	+76	+22	+85	+14
400	500	-45	0	-50	-10	-63	0	-67	-27	-80	-17	-95	-55	-108	-45
				+50	-35	+63	-45	+67	-18	+80	-28	+95	+10	+108	0
				+38	-23	+48	-30	+55	-6	+65	-13	+83	+22	+93	+15

## Deviations of form and position

Permissible deviations of form and position for shaft and housing where bearings will be mounted are given in fig. 4.3 and table 4.5

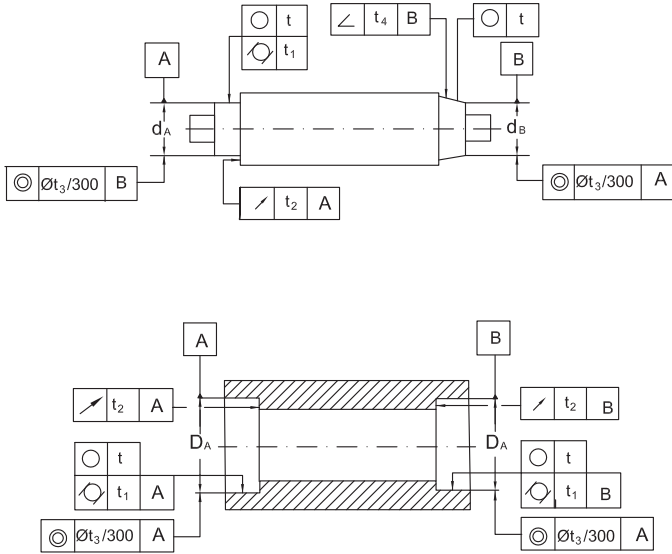

Fig. 4.3

Table 4.5

Tolerance name	Fit	Symbol of deviation	Permissible deviations depending on the tolerance class					
			P0 P6X	P6	P5	P4 (SP)	P2 (UP)	
Tolerance of dimension	shaft		-	IT6(IT5)	IT5	IT4	IT4	IT3
	housing		-	IT7(IT6)	IT6	IT5	IT4	IT4
Tolerance of roundness and cylindricity	shaft		$t, t_1$	IT4/2 (IT3/2)	IT3/2 (IT2/2)	IT2/2	IT1/2	IT0/2
	housing		$t, t_1$	IT5/2 (IT4/2)	IT4/2 (IT2/2)	IT3/2	IT2/2	IT1/2
Tolerance of face runout	shaft		$t_2$	IT4(IT3)	IT3(IT2)	IT2	IT1	IT0
	housing			IT5(IT4)	IT4(IT3)	IT3	IT2	IT1
Tolerance of concentricity	shaft		$t_3$	IT5	IT4	IT4	IT3	IT3
	housing			IT6	IT5	IT5	IT4	IT3
Tolerance of angularity	shaft		$t_4$	IT7/2	IT6/2	IT4/2	IT3/2	IT2/2

In case of bearings on which adapter or withdrawal sleeves are to be mounted, the shaft tolerances for deviations of form and position should be to IT5/2 tolerance class for shafts with diameter tolerance h9 and IT7/2 for shaft tolerance h10.

Surface roughness of bearing seating is given in table 4.6.

Shaft and housing mounting surfaces roughness							Table 4.6	
Bearing tolerance class	Shaft			Housing				
	Diameter d, mm			Diameter D, mm				
	≤ 80	>80...500	> 500	≤ 80	> 80... 500	> 500		
Roughness Ra, [μm]								
<b>P0, P6X and P6</b>	0,8 (N6)	1,6 (N7)	3,2 (N8)	0,8 (N6)	1,6 (N7)	3,2 (N8)		
<b>P5, SP and P4</b>	0,4 (N5)	0,8 (N6)	1,6 (N7)	0,8 (N6)	1,6 (N7)	1,6 (N7)		
<b>P2 and UP</b>	0,2 (N4)	0,4 (N5)	0,8 (N6)	0,4 (N5)	0,8 (N6)	0,8 (N6)		

If bearings are mounted with adapter or withdrawal sleeves, shaft surface roughness should be of max. Ra = 1,6 μm

The values of fundamental tolerances – ISO (tolerance classes IT0...IT12) are given in table 4.7.

Tolerance ISO (IT)														Table 4.7	
Nominal dimension															
over	1	3	6	10	18	30	50	80	120	180	250	315	400	500	
up to	3	6	10	18	30	50	80	120	180	250	315	400	500	630	
mm	Tolerances in micrometers (0,001 mm)														
<b>IT0</b>	0,5	0,6	0,6	0,8	1	1	1,2	1,5	2	3	4	5	6		
<b>IT1</b>	0,8	1	1	1,2	1,5	1,5	2	2,5	3,5	4,5	6	7	8		
<b>IT2</b>	1,2	1,5	1,5	2	2,5	2,5	3	4	5	7	8	9	10		
<b>IT3</b>	2	2,5	2,5	3	4	4	5	6	8	10	12	13	15		
<b>IT4</b>	3	4	4	5	6	7	8	10	12	14	16	18	20		
<b>IT5</b>	4	5	6	8	9	11	13	15	18	20	23	25	27	29	
<b>IT6</b>	6	8	9	11	13	16	19	22	25	29	32	36	40	44	
<b>IT7</b>	10	12	15	18	21	25	30	35	40	46	52	57	63	70	
<b>IT8</b>	14	18	22	27	33	39	46	54	63	72	81	89	97	110	
<b>IT9</b>	25	30	36	43	52	62	74	87	100	115	130	140	155	175	
<b>IT10</b>	40	48	58	70	84	100	120	140	160	185	210	230	250	280	
<b>IT11</b>	60	75	90	110	130	160	190	220	250	290	320	360	400	440	
<b>IT12</b>	100	120	150	180	210	250	300	350	400	460	520	570	630	700	



## Bearing axial location

Axial location of the bearing is necessary for a proper guiding of bearing in an assembly under operation.

A tight fit is inadequate for the axial location of bearing. In case of locating bearings, axial location for both rings is generally needed. Some important solutions of bearing axial location, on shaft or into the housing are shown in Fig. 4.4.

In case of bearings with light axial loads, bearings can be located using a lock nut and a lock washer (a), an end plate fastened by a screw at the shaft end (b) and, for bearings carrying light axial loads, by lock rings mounted in shaft and housing grooves (c).

Bearing with NR design, with groove and snap ring on the outer ring, can be easily located by the lock ring (d). Tapered roller bearings can be located by supporting the inner ring on the shaft shoulder and the outer ring with a threaded ring and a safety plate fastened by a screw (e).

Tapered bore bearings can be mounted and axially located by adapter or withdrawal sleeves (f,g).

The axial load carrying capacity of the bearings mounted with adapter or withdrawal sleeves is governed by the friction between shaft and sleeve (g).

To locate radial bearings, where axial adjustment of the shaft is required, setting washers (i) or spacer rings (j) are used between the outer rings, the width of the spacer ring being experimentally determined, during mounting.

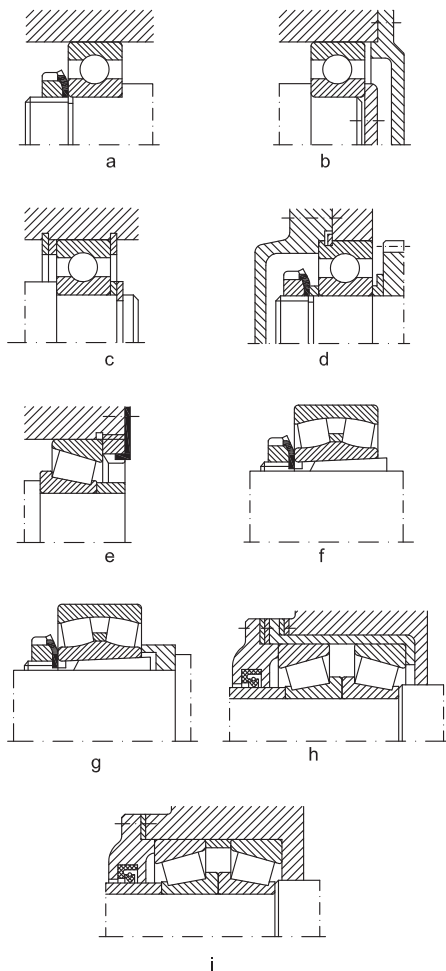

Fig. 4.4

## Bearing sealing

Seals are used in most of bearing arrangements and they must ensure the conditions of a proper operation.

For such a purpose, they have to prevent solid contaminants (dust, hard particles, water, aggressive substances etc) from penetrating into the bearing and at the same time to retain the lubricant in the bearing.

Seals for rolling bearings can be classified

considering some important criteria such as: design, operations, type of lubricant etc.

Considering their design and operation, seals can be: stationary seals between the stationary bearing elements (housing and cover), rotary seals, between the rotating bearing elements and they also can be rubbing seals or non-rubbing seals, which are used in special applications (surrounding conditions and loading stress).

Rotary non-rubbing seals are often used due to their simple design. They are particularly used at high speeds or temperature, both for grease and oil, and have practically no friction and do not wear.

In case of bearing grease lubrication, bearing operating temperature must be lower with  $20^{\circ}\text{C}$  than the dropping point of the grease (melting temperature).

The main constructive types of rotary non-rubbing seals have narrow gaps, labyrinths and their combinations are shown in fig 4.5 a-c.

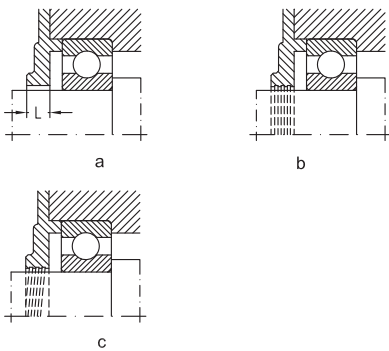

Fig. 4.5

Gap seals represent the simplest constructive solution for a rotary non-rubbing seal which have to retain grease in the bearing housing. The efficacy of sealing depends on the gap length ( $L$ ) and the clearance between shaft and housing. It can be improved by providing one or more circular grooves on the shaft or in the housing, which are to be filled with grease (b). In case of oil lubrication, the grooves on the shaft must be helical (c) and their direction must be the same with the direction on the shaft rotary movement.

Experiments proved that most favorable clearance is obtained between the limits of the fit A11/h10, geometrical deviations should be IT6 and gap surface roughness  $R_a=12,6 \mu\text{m}$ .

Labyrinth seals are used at high peripheral speeds, in impure surroundings.

They are shown in fig. 4.6 a-d.

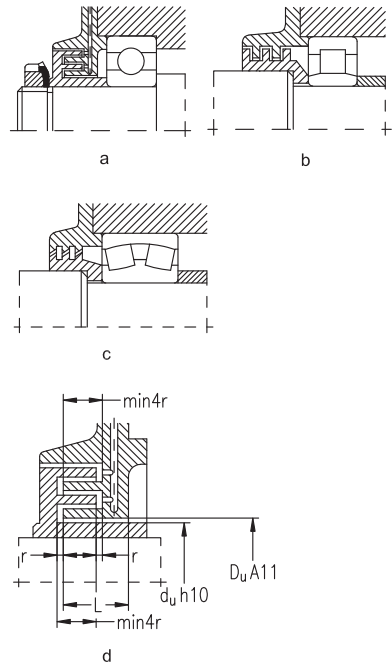

Fig. 4.6

The labyrinths are spaces where periodically water-in-soluble grease (e.g. Lithium or Calcium base grease) is to be supplied.

The tongues of the labyrinth seals can be radially (a), axially (b) arranged or they can have inclined passages.

Details of an axial labyrinth design are given in fig. 4.6 d and values of axial clearance and length  $L$  are given in table 4.8.

In case of rotary rubbing seals there is a direct contact between elastic seal element and the rotating element. They are shown in fig. 4.8.

When selecting the proper rotary rubbing seal, the following factors have to be considered: material and its elasticity (felt, rubber, plastics, leather, graphite, asbestos etc.); resistance at various temperatures, maximum peripheral speeds on sealing surface; sealing direction etc.

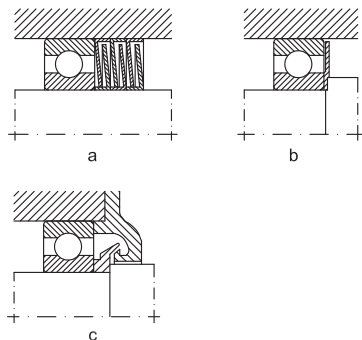

Fig. 4.7

These systems have sealing properties higher than those corresponding to non-rubbing seals. In case of grease lubrication at peripheral speeds higher than 4m/s and temperatures over +100°C, felt ring seals (a) are frequently used because of their simple design and cheapness.

Before mounting, felt rings are impregnated during one hour with a mixture of mineral oil (66%) and paraffin (34%), at a temperature of +70...+80°C so that sealing properties are improved as the friction is reduced.

At higher temperatures and peripheral speeds over 12 m/s, surface roughness is  $R_a=1,6 \mu\text{m}$  and the space between the ends of the seal should be filled with grease. Two felt rings can be used for sealing.

Rubbing seals with a spring incorporated are preferably to be used in case of oil lubricated bearings which are operated under peripheral speeds of 5-10 m/s, temperatures between -40°C and +20°C. Their efficacy depends on the material and operating surroundings.

In most cases, rubbing seals with a spring incorporated are made of synthetic rubber and have a metallic hardening fixture.

Inclined sealing surfaces are recommended to be ground  $R_a=0,8 \mu\text{m}$  and hardened at 45 HRC, when operating at peripheral speeds over 8 m/s. Lubricant outflow can be stopped by mounting the rubbing seal with incorporated spring with edge inwards (c)

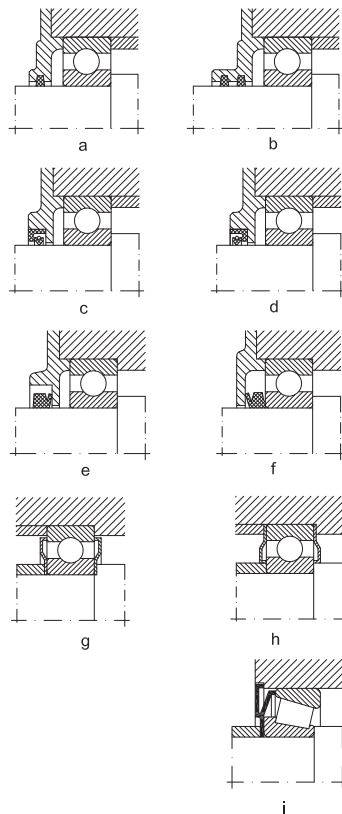

Fig. 4.8

or outwards (d) if sealing has to prevent dust or other impurities from penetrating into the bearing.

Double sealing with these rubbing seals can also be used.

V-ring seal is used to prevent dust or contaminants from penetrating into the bearing with best results both in case of grease or oil lubrication. The elastic rubber lip of the V-ring seal is notched on the plane sealing surface, drawing the fluids in centrifugal motion. V-ring seals are used at temperatures of -40°C...+100°C roughness of sealing surface being  $R_a=1,5 - 3 \mu\text{m}$ . Generally, at peripheral speeds up to 15 m/s, the V-ring seal operates as a rubbing seal (seal lip reaches sealing surface), and at peripheral speeds over 15 m/s the seal lip will lift from the



sealing surface, operating as a centrifugal sealing.

V-ring seals can also be used in case of angular misalignment of the shaft ( $2^{\circ}\text{C} \dots 3^{\circ}\text{C}$ ) as they are made of high quality, elastic rubber, easy to be mounted.

The efficacy of sealing depends on the fact that the body ring acts as a flinger for dirt and fluids. Therefore, with grease lubrication the seal is generally arranged outside the housing and with oil lubrication it is placed inside the housing.

Pressed sheet washers provide simple, inexpensive and space-saving sealing especially for grease lubricated deep groove ball bearings. The washers are clamped against either the outer ring or the inner ring and exert a resilient pressure axially against the rubbing ring. In case of usual applications, the types of seals mentioned above or their combinations shown in fig. 4.9 are used, some of them becoming standard seals for rolling bearings (e.g. labyrinths, felt rings, V-rings etc). Thus, better sealing can be obtained if felt ring (a) or V-ring (b) rubbing seals are combined with radial or axial labyrinth non-rubbing seals.

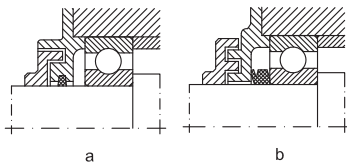

Fig. 4.9

Special seals are used in case of unusual surroundings and loading conditions (e.g. rolling mills, helm of ocean-vessels, main shaft of grinding machines etc).

Sealed bearings of the type 2RS (2RSR) (a) or shielded bearings of the type 2Z (ZZR) (b) shown in fig. 4.10 a.b. provide simple and inexpensive sealing, with upper operating results. These rolling bearings are delivered ready greased, provision for relubrication and maintenance are not needed. They are used in case of bearings with small free space where other seals cannot be used.

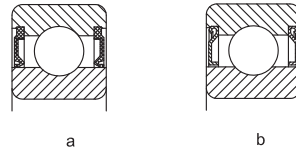

Fig. 4.10



# Bearing lubrication

Safe operating and long rating life of bearings depend on the lubricant type and quality and on the lubrication method. Bearing lubrication is used for certain purposes, such as:

- to reduce friction between rolling elements and raceway, rolling elements and cage
- to reduce friction between rolling elements and raceway, rolling elements and cage, cage and guiding ribs of rings during operation;
- to ensure anticorrosive protection of bearings;
- to reduce noise in bearing within certain limits;
- to distribute heat uniformly in contact areas and to remove it outside through lubricant circulation.

Lubricants for bearings lubrication should satisfy the following conditions:

- they should have physical and chemical stability;
- foreign mechanical substances (abrasive, metallic substances etc.) are not admitted in lubricant;
- they should have a minimal coefficient of friction;
- to be non-corrosive;
- good unctuosity (lubricating capacity).

There are two categories of lubricants used for bearing lubrication:

- fluid lubricants (oils);
- plastic lubricants (greases).

Table 5.1 shows comparison between fluid and plastic lubricants.

Although fluid lubricants have better characteristics than plastic lubricants, they cannot be used in all cases because of sealing difficulties.

Characteristics	Lubricant	
	Fluid	Plastic
speed	any value	low and medium
friction	low (reduced)	high
unctuosity	excellent	good
service life	long	short
cooling effect	high	low
replacement	easy	difficult

## Selection of lubricants

When selecting lubricants, much care is needed and all operating conditions and lubricant properties

should be considered.

No lubrication system can be considered universal. The most important criteria when selecting a lubricant have to be as follows:

- size of bearing
- speed
- load
- bearing operating temperature

These characteristic act upon lubricant viscosity as follows:

- the higher the bearing size, value of load and temperature, the higher the viscosity
- bearing speed acts by product  $D_m * n$ , as show in table 5.2.

$D_m * n$ over	up to	Lubricant type
-	150x10 <sup>3</sup>	Mineral oil and grease with medium or high viscosity
150x10 <sup>3</sup>	300x10 <sup>3</sup>	Mineral oil with medium viscosity and grease
300x10 <sup>3</sup>	500x10 <sup>3</sup>	Mineral oil with low viscosity and grease
500x10 <sup>3</sup>	1200x10 <sup>3</sup>	Mineral oil with low viscosity and lubricating equipment

## Grease lubrication

Grease can be used to lubricate rolling bearings only when product  $D_m * n \leq 500x10^3$  and it offers the following advantages:

- bearing speed acts by product  $D_m n$ , as show in table 5.2.
- it is more easily retained in the bearing;
- it assures anti-corrosive protection to bearing as it is water-resistant;
- low expenses for sealing.

The grease quantity to be supplied shouldn't be excessive, otherwise rotation is bracket, friction increases and also operating temperature without extending the bearing rating life.

The quantity of grease that is to be inserted in bearing seating should be as follows, considering the free space inside the housing:

- 1/2... 3/4 of the free space in the housing, in case of normal speeds;
- 1/3 of the free space in the housing, in case of high speeds and speed limit;
- whole housing freespace should be free, in case of low speeds and product  $D_m * n < 10 \times 10^3$ .

The quantity of grease can be calculated as a function of bearing bore diameter using the equation:

$$G = K d^{2.5}, g.$$

where:

- K= 1/900 - for ball bearings
- K= 1/350 - for roller bearings
- d = bore diameter, mm

Relubrication intervals in most cases can be experimentally determined and depend on:

- bearing type
- bearing size
- operating temperature
- grease properties

Grease service life and rubricating interval can be calculated from:

$$Tur = k_0 \left( \frac{14 \cdot 10^6}{n\sqrt{d}} - 4d \right) f_1 f_2,$$

where:

- $T_{ur}$  = service life or rubricating interval, in operating hours
- $k_0$  = coefficient depending on the bearing type, table 5.3
- n = speed, r/min
- d = bore diameter, mm
- $f_1$  = temperature factor, table 5.4
- $f_2$  = factor depending on the operating conditions, table 5.5

Low values are valid for deep groove ball bearings with shields, 2Z type, or with seals, 2RS type, series 60, 62 and 63.

Bearing relubrication interval can be also determined using the chart - fig. 5.1, as a function of bearing type, bore diameter and speed.

**Example:**

A bearing 6208-2RSR is operated under reduced load (it is not considered for calculation), at a speed  $n = 1500$  r/min, at a temperature of +60 deg C, light operating conditions. What is the grease service life and relubrication interval?

Grease service life will be:

$$T_u = k_0 \cdot \left( \frac{14 \times 10^6}{n\sqrt{d}} \cdot 4d \right) f_1 f_2 = 32\ 893 \text{ hours.}$$

- $k_0 = 25$ , from table 5.3
- d = 40 mm
- $f_1 = 1$ , from table 5.4
- $f_2 = 1$ , from table 5.5

Relubrication interval:

$$T_r = k_0 \cdot \left( \frac{14 \times 10^6}{n\sqrt{d}} \cdot 4d \right) f_1 f_2 = 13\ 157 \text{ hours.}$$

- $k_0 = 10$ , from table 5.3
- $f_1, f_2 = 1$ , from tables 5.4, 5.5.

The grease quantity to be supplied can be determined using the equation:

$$G = K D B, g,$$

**Values for coefficient  $k_0$**  Table 5.3

Bearing type	Value of $k_0$	
	Relubrication interval	Grease service life
Angular contact ball bearings Tapered roller bearings Thrust ball bearings	1	2
Cylindrical roller bearings	5	15
Deep groove ball bearings	10	20...40

**Values for factor  $f_1$**  Table 5.4

Temperature	70°C	85°C	100°C
Factor $f_1$	1	0,5	0,25



Values for factor $f_2$				
Table 5.5				
Operating conditions	Light	Moderate	Heavy	Very heavy
Factor $f_2$	1	0,7...0,9	0,4...0,7	0,1...0,4

Values for coefficient K	
Table 5.6	
Relubrication interval	K
weekly	0,0015...0,0020
monthly	0,0020...0,0030
yearly	0,0030...0,0045
after 2...3 years	0,0045...0,0055

From the diagram fig. 5.1, the value of the relubrication interval will be of 13500 operating hours.

where:

$G$  = grease quantity, g

$K$  = coefficient depending on the relubrication interval, table 5.6

$D$  = bearing outside diameter, mm

$B$  = total bearing width for radial bearings, mm and total bearing height for thrust bearings, mm

The chart in fig. 5.1 applies to operating temperatures which do not exceed  $+70^\circ\text{C}$ . For operating temperatures over  $+70^\circ\text{C}$ , see table 5.4.

Grease service life can be defined as the period of time when it preserves physical and mechanical characteristics in time and oxidizing due to temperature and vaporization of base oil doesn't occur.

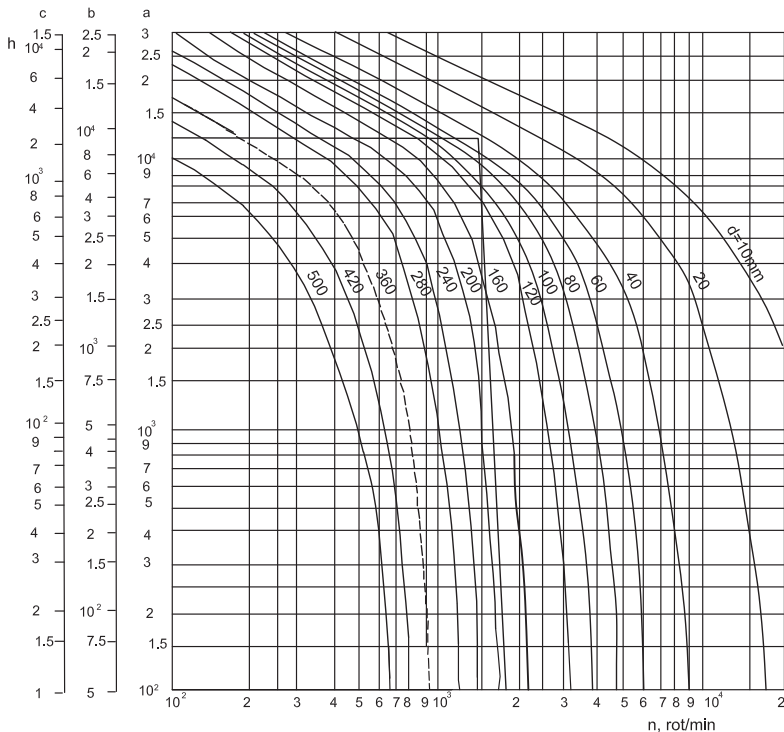

Fig. 5.1

Scale a; deep groove ball bearings

Scale b; cylindrical roller bearings

Scale c; spherical roller bearings, thrust ball bearings, cylindrical roller bearings without cage.

A more accurate calculation of grease service life, considering grease quality and bearing operating conditions (load, size, speed, temperature etc.) can be done using the equation:

$$L = 10^{a-(m_1+m_2+m_3)}$$

where:

L = service life, operating hours

a = exponent depending on the grease quality (a=5,8... 6,1)

m<sub>1</sub>... m<sub>3</sub> = exponents which take into account the following factors:

$$m_1 = 4,4 \times 10^{-8} D_m * n,$$

$$m_2 = 2,5 (P/C - 0,05),$$

$$m_3 = (0,021 - 1,80 \times 10^{-6} D_m * n) t,$$

D<sub>m</sub> = bearing mean diameter, mm

n = bearing speeds, r/min,

P = equivalent radial load, kN,

C = basic dynamic load, kN,

t = bearing operating temperature, °C

When calculating the values of t, D<sub>m</sub> \* n and P/C, the following have to be considered:

- when bearing operating temperature is lower than +50°C, then t = +50°C

- when speed factor D<sub>m</sub> \* n < 125000, then D<sub>m</sub> \* n = 125000

- when ratio P/C < 0,05, then P/C = 0,05

Grease service life, as a function of operating temperature can be approximately determined using the diagram fig. 5.2.

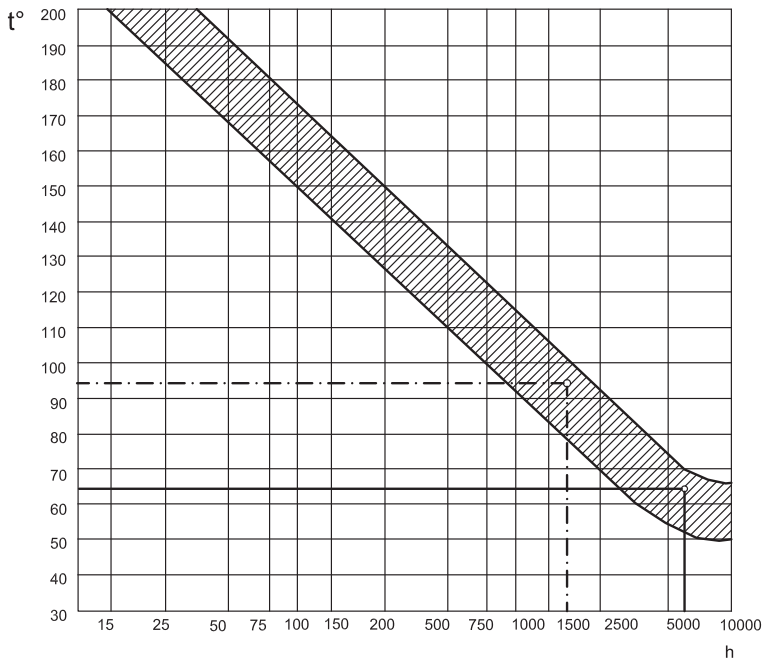

Fig. 5.2

### Example 1

A bearing 6210 operates under a load  $Pr = 5 \text{ kN}$ , speed  $n = 3000 \text{ r/min}$  at an operating temperature  $t = 50^\circ\text{C}$ . What is the service life of the grease used for bearing lubrication?

$Cr = 35,1 \text{ kN}$ , tables on page 100. bearing 6210  
 $L = 10^{a \cdot (m_1 + m_2 + m_3)} = 10^{6,1 \cdot 2,273} = 6214 \text{ hours}$

$a = 6,1$ , for Mobil grease,

$D_m * n = 65 \times 3000 = 195 \times 10^3$

$Pr/Cr = 5/35,1 = 0,143$

$m_1 = 4,4 \times 10^{-6} D_m * n = 0,858$

$m_2 = 2,5 (Pr/Cr - 0,05) = 0,23$

$m_3 = (0,021 - 1,80 \times 10^{-8} D_m * n) 65 = 1,119$

### Example 2

For the same bearing and operating conditions as in Example 1, it is required to find the service life of the same grease at a temperature of  $t = 95^\circ\text{C}$ .

$m_3 = 1,66$

$m_1 + m_2 + m_3 = 2,794$

$L = 10^{6,1 \cdot 2,794} = 10^{3,306} = 1774 \text{ operating hours}$

From the diagram fig. 5.2, we can find approximately the same value, respectively 6000 operating hours at  $+65^\circ\text{C}$  and 170° operating hours at  $+95^\circ\text{C}$ .

Table 5.7 shows technical characteristics of usual grease, which are recommended for lubrication of sealed and shielded bearings, 2RS and 2Z types and also for rolling bearings in various assembled and machines.

Technical characteristics for usual greases for bearing lubrication					
Application	Thickener	Base Oil Viscosity @40°C	NLGI	Operating temperature range	Grease
General purpose industrial use, normal operation condition	Lithium	150	2	-30...+120	Mobilux EP2
	Lithium	100	3	-20...+130	Shell Gadus S2 V100 3
High temperatures and speeds. Long life. Low-noise performance (electric motors).	Polyurea	113	2	-20...+160	Mobil Polyrex™ EM
	Polyurea , EP	220	2	-20...+160	Shell Gadus S3 T220 2
High load, low-medium speed (cement, steel, crushers)	Lithium, EP	540	-	-20...+140	Klüberlub BE 41- 542
	Lithium complex, EP	460	2	-20...+140	Mobilgrease XHP 462
	Lithium complex, EP	460	2	-20...+150	Shell Gadus S3 V460 2
High temperature	Polyurea	100	2	-40...+180	Shell Gadus S5 T100 2
	Polyurea, EP	150	2	-40...+175	Mobil Polyrex EP2
	Polyurea	80	-	-40...+180	Klübersynth BQP 72-82
High-speed and spindle bearing grease	Polyurea	22	-	-50...+120	Klüberspeed BF 72-22
Low noise, high purity	Polyurea	72	-	-45...+180	Klüberquit BQ 72-72

When selecting a grease, following properties should be analyzed (thickener type, oil viscosity, operating conditions and application, NLGI grade -consistency).

Also, consult very carefully grease data sheet.

## Oil lubrication

Oil lubrication can be used in any operating condition, but this kind of lubrication is compulsory when the value of the product  $D_m * n$  from table 5.2 is exceeded for grease, namely  $D_m * n > 500 \times 10^3$  and when high temperatures occur in bearing. Then, oil has to lubricate and to remove heat from bearing.

Oils used for bearing lubrication can be:

- mineral oils, used up to a temperature of +150°C.

- synthetic oils, used up to a temperature of +220°C.

For a proper lubrication of bearings, low quantities of lubricants to reach the rolling elements are needed.

The lubricating systems must provide oil quantity necessary to prevent oil draining from bearing and heat removal in case of high speeds.

Most usual oil lubricating systems depending on factor  $D_m * n$  are given in tables 5.8.

Oil lubricating systems				
Table 5.8				
Lubricating system	Operating conditions	Factor $D_m * n$	Oil viscosity at 40°C	Example in fig.
m <sup>2</sup> /s				
Oil bath	Bath is filled up to the lowest rolling element for horizontal shaft and 70-80% of bath width for vertical shaft	$< 250 \times 10^3$	$(17...300) \times 10^{-6}$	5.3 a), b)
Oil bath with external circulation	Central tank, oil circulates under a pressure of 1,5 MPa. High speeds.	$< 600 \times 10^3$	$(45...175) \times 10^{-6}$	5,4
Oil injection	Oil is injected into the operating area under a pressure of 0,1...0,5 MPa, with flow capacity of 0,5...10 l/min depending on temperature. Heavy loads and high speeds.	$< 900 \times 10^3$	$(13,5...80) \times 10^{-6}$	5,5
Oil spot	Oil in air current under a pressure of (0,05...0,5) MPa, flow capacity of (0,5...4) m <sup>3</sup> /hour for small and medium sized bearings, heavy loads and high speeds.	$< 1200 \times 10^3$	$(10...45) \times 10^{-6}$	5,6

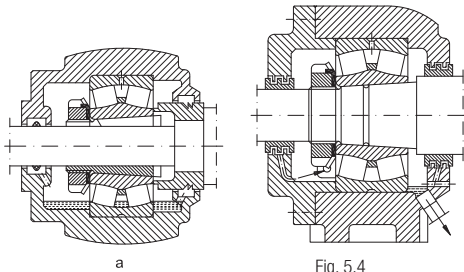

a

Fig. 5.4

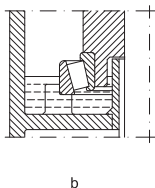

Fig. 5.3

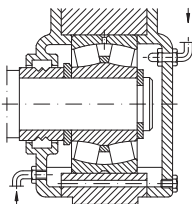

Fig. 5.5

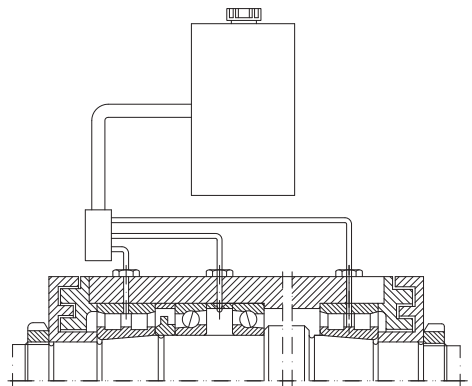

Fig. 5.6



Approximate values of oil kinematic viscosity at +40°C depending on the operating temperature are given in table 5.9.

Temperature t°C		Viscosity at 40°C, cSt
over	up to	
-	50	12...60
50	80	37...75,5
80	120	> 75,5
120	150	227

Diagram fig. 5.7 shows kinematic viscosity classes at 40°C in accordance with ISO, its variation depending on the operating temperature (t°C) in relation to speed and bearing mean diameter (Dm).

**Example**

A bearing 6204 is to operate under a speed  $n = 2000 \text{ r/min}$  at a temperature  $t = +65^\circ\text{C}$ .

$D_m = 0,5 (d+D) = 35,5 \text{ mm}$ .

The viscosity of the oil for bearing lubrication is required.

From the diagram, for  $D_m = 35,5 \text{ mm}$ , we can find viscosity at +65°C,  $\nu_1 = 13 \text{ cSt}$  and viscosity at + 40°C,  $\nu = 32\text{cSt}$ .

Table 5.10 shows oils which are recommended by ISO for bearing lubrication. Values of kinematic viscosity at +40°C, mm²/s are also given.

Class	Kinematic viscosity at +40°C, mm²/s (cSt)			
	ISO	mean	low	high
ISO VG	2	2,2	1,98	2,42
ISO VG	3	3,2	2,88	3,52
ISO VG	5	4,6	4,14	5,06
ISO VG	7	6,8	6,12	7,48
ISO VG	10	10	9	11
ISO VG	15	15	13,5	16,5
ISO VG	22	22	19,8	24,2
ISO VG	32	32	28,8	35,2
ISO VG	46	46	41,4	50,6
ISO VG	68	68	61,2	74,8
ISO VG	100	100	90	110
ISO VG	150	150	135	165
ISO VG	220	220	198	242
ISO VG	320	320	288	352
ISO VG	460	460	414	506
ISO VG	680	680	612	748
ISO VG	1000	1000	900	1100
ISO VG	1500	1500	1350	1650



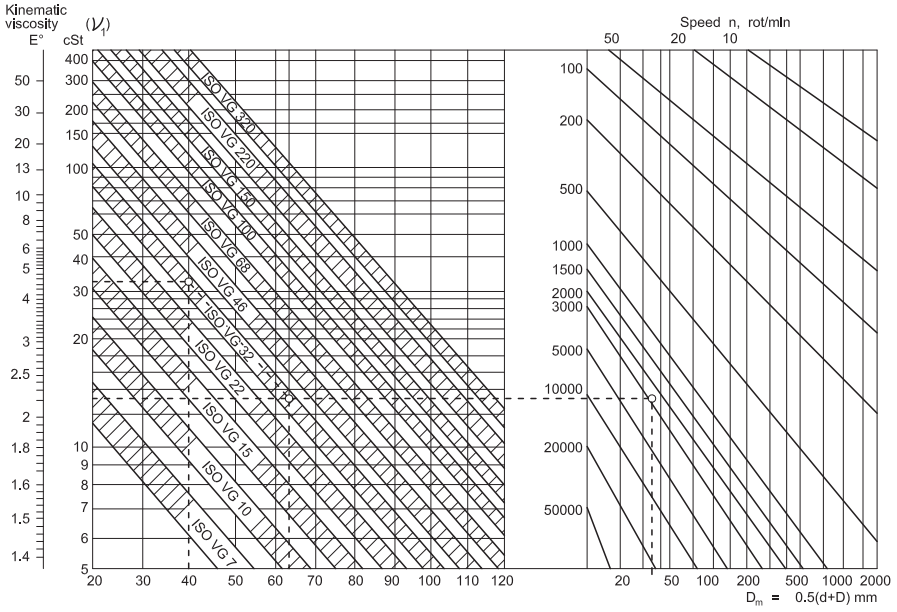

Fig. 5.7



# Bearing designation

The purpose of designation is that of identification of bearings, so that bearings with the same designation to be interchangeable both dimensionally and operationally, no matter who the producers may be. Designation of URB rolling bearings are in

accordance with those used by world-know bearing companies: SKF, FAG , INA, KOYO etc.

The complete designation of a bearing consists of a basic design and may include one or more supplementary designations (prefixes and suffixes), as shown in chart fig. 6.1.

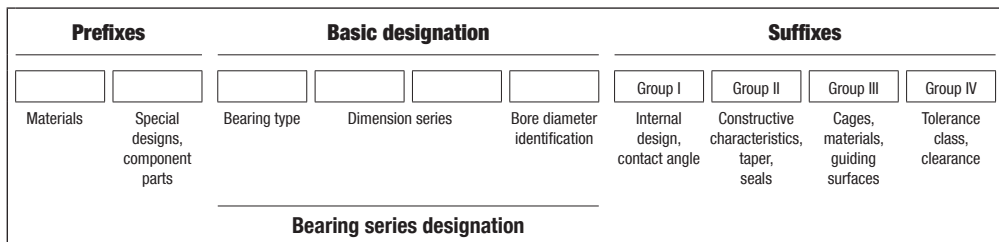

Fig. 6.1

The basic designation consists of an identification of the type of bearing (figure or letter), the series designation, in accordance with ISO and the bore diameter identification.

The designation of the bearing type and dimension series, for main standardized bearing types, is given in table 6.1.

Bore diameter identification consist of one, two or more figures as follows:

- bore diameter from 1 to 9 mm - one figure, representing the bore diameter (e.g. 623, 608);

- bore diameter from 10 to 495 mm - two figures, as follows: 00 for 10 mm, 01 for 12 mm, 02 for 15 mm, 03 for 17 mm, 04 and up to 99 for bore diameter from 20 to 495 mm. (bore diameter = bore diameter identification x 5, e.g. 6230, d=150 mm);

- bore diameter of 500 mm and over 500 mm

- is stated directly separated by a slash, the same applies to the values which are not perfect multiples of 5, or if they include a decimal point (e.g. 610/560, 62/32, 62/1,5).

Tapered roller bearings with inch dimensions listed in this catalogues make an exception from this rule.

## Prefixes

Prefixes are letter-identifications which indicate the material, other than steel for bearings or component parts of bearing. The prefix for material is separated by a horizontal line from the rest of designation.

### Prefixes for materials

- H** - heat-resisting steel (e.g. H - NUP 210)
- M** - copper alloy (e.g. M - 6008)
- S** - plastics, glass, ceramics etc. (e.g. S - 6204)
- T** - case-hardening steel (e.g. T - 35352)

## Prefixes for special designs or parts of bearings















- K** - cage with rolling elements of dismountable bearing (e.g. KNU205)
- L** - free ring of dismountable bearing (e.g. LNU205) (interchangeable ring, e.g. L30205)
- R** - dismountable bearing without free ring (e.g. RNU205; RN205)
- E** - shaft washer of thrust ball bearing (e.g. E51210)
- W** - housing washer of thrust ball bearing (e.g. W51216)

## Suffixes

Suffixes are used to identify various constructive modifications of the bearing in comparison to normal design. They are classified in four different groups, as follows:

- Group I - Modifications of internal design, design with increased basic load (e.g. A, C, E etc.), contact angle (e.g. A, B, C) and others.
- Group II - Modifications of external design, tapered bore, groove on outer ring etc. (e.g. 30205A, 1210K, 6210NR, 6310-2RS)
- Group III - Modifications of cage design, material, guiding surfaces etc. (e.g. 6205TN, NU310MA)
- Group IV - Modifications of normal design regarding tolerance classes, bearing radial or axial clearance, stability of dimensions at high temperatures, bearing matching etc. (e.g. 6206P5, 6310P53, NU210SO, 7010CDB).

These suffixes for bearing designation are listed considering the groups they belong to, at the beginning of each bearing group.

Designation of the type and dimension series for the standardized bearings			
Table 6.1			
Bearing design	Bearing type identification	Series designation	Example
	6	18 10 03 19 02 23 00 22 04	61952 6208
	1	10 03 02 23 22	1205 11210
	7	10 02 03	7030C 72108
	0	32 33	3207 33160
	NU	10 02 22 03	NU208
	NJ	23 04	NU2206
	N		N310 N5161M
	NUP		NUP209
	NNU	49	NNU4920
	NN	30	NN3015
	2	30 41 13 40 22 23 31 32	22216 25130
	3	29 22 23 20 03 02 13	32010 32208 34115
	5	11 13 12 14	51115 51212
	5	22 23 24	52205 52308



## Mounting and dismounting

Proper operation of rolling bearings is also determined by a proper selection of the solution of mounting and dismounting, considering the type and size of bearing, fit, adequate tools for these operations, performance etc.

As being precision components, rolling bearings should be handled carefully when storing or mounting. Thus, the following conditions should be observed:

- storing in their original package, on special shelves, in dry room, temperature of  $+18^{\circ}\text{C} \dots +20^{\circ}\text{C}$ , maximum moisture degree of 60%

- handling bearings, while storing and mounting, should be carefully done so that original package to be protected and not to be deteriorated

- bearings should be unpacked only when they are to be mounted

They shouldn't be washed if original package hasn't been destroyed

- as the adjoin parts of bearing are accurate, without burrs, chips or hits, special care should be taken.

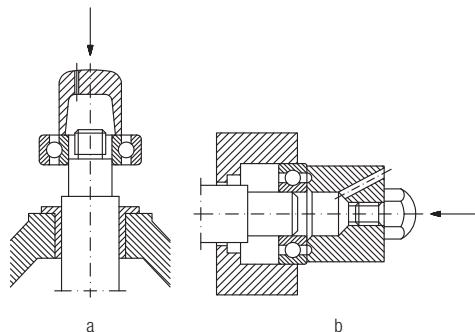

Fig. 7.1

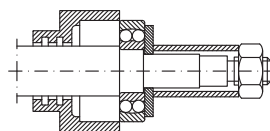

Fig. 7.2

### Mounting of bearings with cylindrical bore

Bearings with cylindrical bore which are to have tight fit on shaft or in housing respectively will be mounted by mechanical, thermic or hydraulic means.

The pressing force should be transmitted only by the ring which is pressed on the shaft or into the housing bore. Transmission by rolling bearings should be avoided as they can get deformed and premature damage can occur.

Special sleeves with one or two ribs, fig. 7.1, a and b are used when mounting small and medium-sized bearings, which are to be mounted with transition fit. In case of self-aligning ball bearings or spherical roller thrust bearings, a plate is mounted for a proper location of the outer rings, as shown in fig. 7.2.

Mechanical or hydraulic presses are used as shown in fig. 7.3, in case of serial production so that force can be continuously and gradually applied.

For the mounting of bearings with clearance fit into the housing or on the shaft, the ring with transition or tight fit should be mounted first, after which the shaft-bearing assembly will be mounted into the housing as shown in fig. 7.4, a and b.

In case of dismountable bearings, rings can be mounted separately - fig. 7.5, even if a tight fit is required for both rings.

The mounting of medium ( $d > 50 \text{ mm}$ ) and large-sized bearings with tight fit, requires much greater pressing forces. That's why in this case heating of bearings up to  $+80^{\circ}\text{C} \dots +110^{\circ}\text{C}$  should be used instead of pressing, excepting shielded bearings, 2Z (2ZR) type and sealed bearings, 2RS (2RSR) type.

For the bearings heating, oil bath, electric range, heating device with thermic ring or induction heating device etc. can be used as shown in fig. 7.6, a-d.

The device with thermic ring - fig. 7.6 c consists of a split aluminum ring with three grips and cuts which

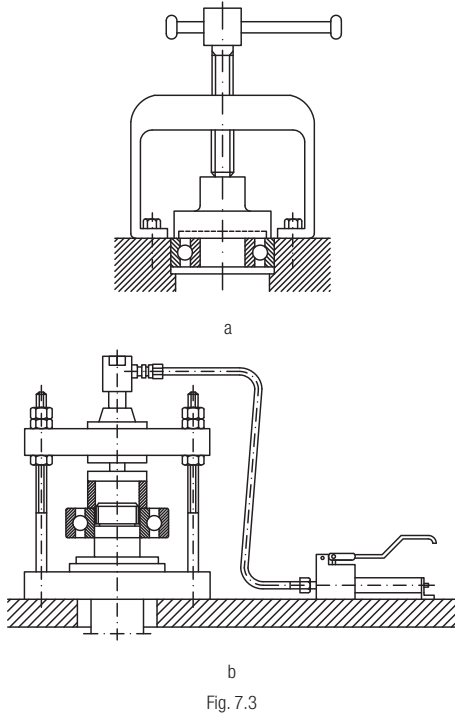

Fig. 7.3

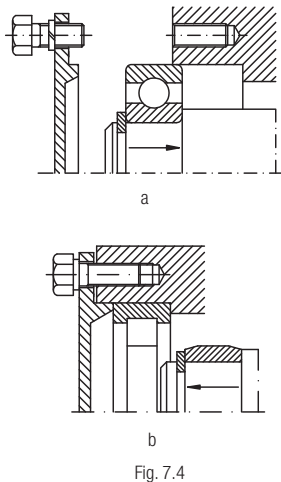

Fig. 7.4

make it be elastic.

Thermic ring bore diameter is equal to inner ring raceway diameter of dismountable bearings.

The ring outside diameter can be calculated using the equation:

$$D_{ex} = \sqrt{4d_1^2 - 3d^2}$$

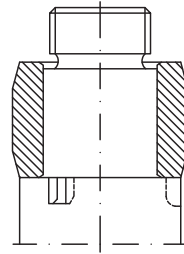

Fig. 7.5

where:

- $D_{ex}$  = outside diameter of the thermic ring, mm
- $d_1$  = diameter of the inner ring raceway, mm
- $d$  = bearing bore diameter, mm

The mass of the thermic ring is approximately equal to the mass of the bearing inner ring.

In case of large-sized cylindrical roller bearings, heating is done with induction devices. These devices consist of a coil inductor, thermal relays for temperature adjustment and timers. 380 V voltage and 50 - 60 Hz frequency inductors are used for bearings with bore diameter up to 200 mm.

For larger sized bearings, 20... 40 V voltage and 50 - 60 Hz inductors are used.

This device is schematically shown in fig. 7.6 d.

### Mounting of bearings with tapered bore

Tapered bore bearings can be mounted directly on the shaft, on adapter sleeve or withdrawal sleeve. These bearings should always be mounted only with a tight fit. The tight fit can be done by an axial displacement of the bearing inner ring which

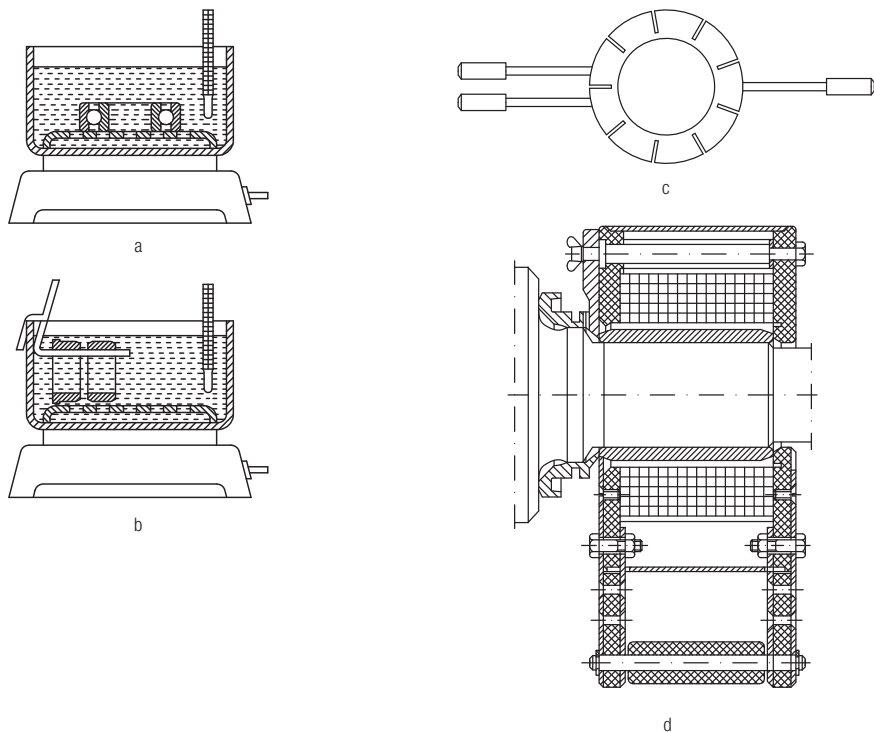

Fig. 7.6

**Values for self-aligning ball bearings radial clearance, after mounting**

Values in mm

Table 7.1

Bore diameter d		Reduction of radial clearance		Axial displacement „a”, taper 1:12				Minimum radial clearance after mounting, in case of clearance group	
				on tapered shaft		on tapered sleeve			
over	up to	low	high	low	high	low	high	normal	C3
-	20	0,003	0,01	0,22	0,23	0,24	0,25	0,01	0,02
20	30	0,005	0,01	0,22	0,23	0,23	0,24	0,01	0,02
30	40	0,009	0,015	0,3	0,3	0,32	0,32	0,01	0,02
40	50	0,01	0,016	0,31	0,34	0,35	0,37	0,015	0,025
50	65	0,012	0,018	0,39	0,41	0,4	0,42	0,015	0,03
65	80	0,015	0,025	0,43	0,47	0,45	0,5	0,02	0,04
80	100	0,022	0,03	0,54	0,6	0,56	0,62	0,02	0,04
100	120	0,025	0,035	0,58	0,7	0,6	0,75	0,025	0,055

is mounted directly on the tapered spindle of the shaft or by an axial displacement of the adapter or withdrawal sleeve.

The values of reduction in radial clearance are given in tables 7.1 and 7.2, as function of axial displacement on shaft of self-aligning ball bearings and spherical roller thrust bearings. After mounting the initial radial clearance is to be considered.

After mounting, radial clearance of radial and self-aligning ball bearings are in accordance with table 7.1.

The values of tightening are estimated by the values of the radial clearance reduction or of axial displacement. Axial displacement of the mounted bearings is measured by means of a limit gauge, as shown in fig. 7.7, a and b. The thickness of the limit gauge can be calculated from:

$$m = S - a$$

where:

m = thickness of the limit gauge, mm

S = distance initially measured, mm

a = axial displacement, from table 7.1, mm

Values for spherical roller bearings radial clearance, after mounting														
Values in mm														
Bore diameter d		Reduction of radial clearance		Axial displacement „a”, taper 1:12				Axial displacement „a”, taper 1:30				Minimum radial clearance after mounting, in case of clearance group		
				on tapered shaft		on tapered sleeve		on tapered shaft		on tapered sleeve				
over	up to	low	high	low	high	low	high	low	high	low	high	normal	C3	C4
30	40	0,02	0,025	0,35	0,4	0,35	0,45	-	-	-	-	0,015	0,025	0,04
40	50	0,025	0,03	0,4	0,45	0,45	0,5	-	-	-	-	0,02	0,03	0,05
50	65	0,03	0,04	0,45	0,6	0,5	0,7	-	-	-	-	0,025	0,035	0,055
65	80	0,04	0,05	0,6	0,75	0,7	0,85	-	-	-	-	0,025	0,04	0,07
80	100	0,045	0,06	0,7	0,9	0,75	1	1,7	2,2	1,8	2,4	0,035	0,05	0,08
100	120	0,05	0,07	0,7	1,1	0,8	1,2	1,9	2,7	2	2,8	0,05	0,065	0,1
120	140	0,065	0,09	1,1	1,4	1,2	1,5	2,7	3,5	2,8	3,6	0,055	0,08	0,11
140	160	0,075	0,1	1,2	1,6	1,3	1,7	3	4	3,1	4,2	0,055	0,09	0,13
160	180	0,08	0,11	1,3	1,7	1,4	1,9	3,2	4,2	3,3	4,6	0,06	0,1	0,15
180	200	0,09	0,13	1,4	2	1,5	2,2	3,5	4,5	3,6	5	0,07	0,1	0,16
200	225	0,1	0,14	1,6	2,2	1,7	2,4	4	5,5	4,2	5,7	0,08	0,12	0,18
225	250	0,11	0,15	1,7	2,4	1,8	2,6	4,2	6	4,6	6,2	0,09	0,13	0,2
250	280	0,12	0,17	1,9	2,6	2	2,9	4,7	6,7	4,8	6,9	0,1	0,14	0,22
280	315	0,13	0,19	2	3	2,2	3,2	5	7,5	5,2	7,7	0,11	0,15	0,24
315	355	0,15	0,21	2,4	3,4	2,6	3,6	6	8,2	6,2	8,4	0,12	0,17	0,26
355	400	0,17	0,23	2,6	3,6	2,9	3,9	6,5	9	6,8	9,2	0,13	0,19	0,29
400	450	0,2	0,26	3,1	4,1	3,4	4,4	7,7	10	8	10,2	0,13	0,2	0,31
450	500	0,21	0,28	3,3	4,4	3,6	4,8	8,2	11	8,4	11,2	0,16	0,23	0,35
500	560	0,24	0,32	3,7	5	4,1	5,4	9,2	12,5	9,6	12,8	0,17	0,25	0,36
560	630	0,26	0,35	4	5,4	4,4	5,9	10	13,5	10,4	14	0,2	0,29	0,41
630	710	0,3	0,4	4,6	6,2	5,1	6,8	11,5	15,5	12	16	0,21	0,31	0,45
710	800	0,34	0,45	5,3	7	5,8	7,6	13,3	17,5	13,6	18	0,23	0,35	0,51

Table 7.2

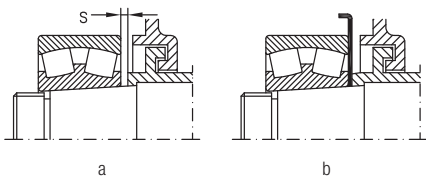

Fig. 7.7

**Example**

A bearing 22252,  $d = 260$  mm, taper: 1:12, distance  $S = 10$  mm, distance "a" from table 7.1 = 1,90 mm,  $m = 10 - 1,9 = 8,10$  mm

Small-sized bearings with tapered bore which are to be mounted directly on the shaft or with adapter or withdrawal sleeves can be axially displaced by means of a nut as shown in fig. 7.8, a, or by means of a special sleeve as in fig. 7.8 b, c.

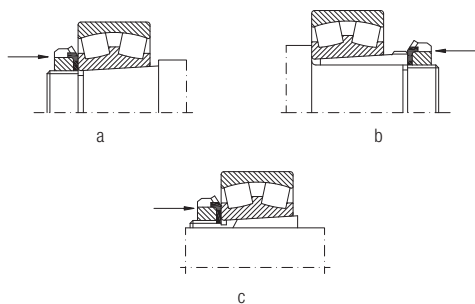

Fig. 7.8

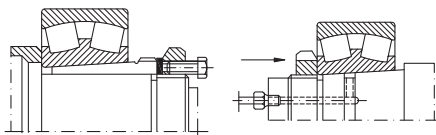

Fig. 7.9

Fig. 7.10

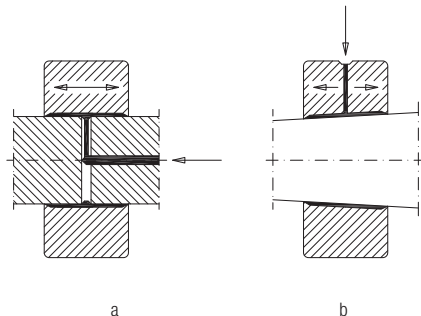

Fig. 7.11

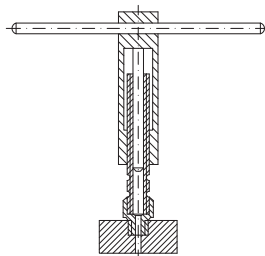

Fig. 7.12

Medium-sized bearings can be axially displaced by means of a special nut as shown in fig. 7.9 and some screws. Then, the nut is to be dismantled and replaced with a nut for axial fastening. Special hydraulic presses - fig. 7.11 are used to mount medium and large-sized bearings.

To reduce the bearing displacing force in case of large-sized bearings, pressurized oil is to be introduced between the tapered surfaces of the shaft spindle, bearing and b, by means of oil pump - fig. 7.10 or oil injector - fig. 7.12.

One or more grooves, should be provided as shown in fig. 7.13, a and b so that oil can be distributed between the mounting surfaces.

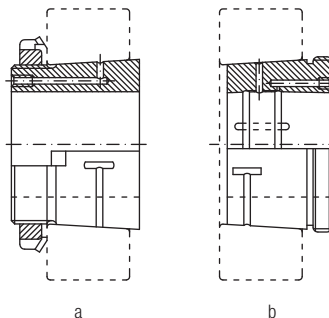

Fig. 7.13



## Bearing dismounting

When bearings with tapered bore are to be dismounted from the shaft or housing, the succession of operations is inversely done than in case of mounting.

Thus, the assembly mounted with clearance fit or small tightening is to be dismounted first and then the parts mounted with greater tightening, as shown in fig. 7.14 and fig. 7.15.

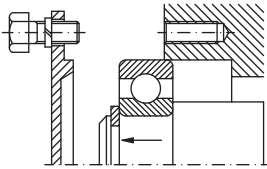

Fig. 7.14

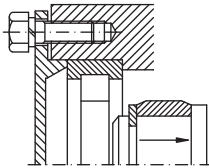
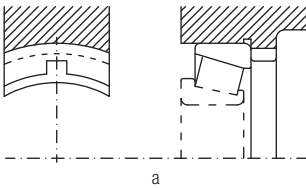
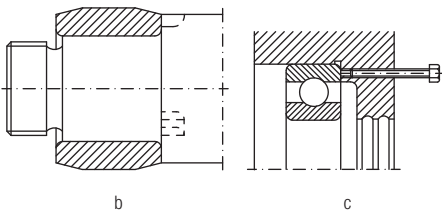

Fig. 7.15



a



b

c

Fig. 7.16

To use mechanical or hydraulic instruments, when dismounting bearings, a special design of the shaft and housing is required, as shown in fig. 7.16, a-c: withdrawal grooves (a) and (b), threaded bores (c), grooves for oil distribution, fig. 7.13.

Medium and small-sized bearings which are mounted with a tight fit are dismounted from the shaft by means of a soft steel or copper mandrel or by means of mechanical or hydraulic presses fig. 7.17, a-c.

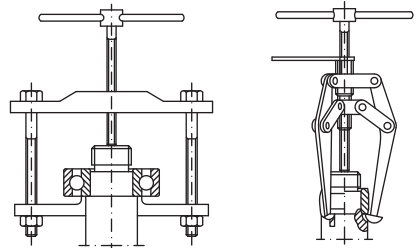

a

b

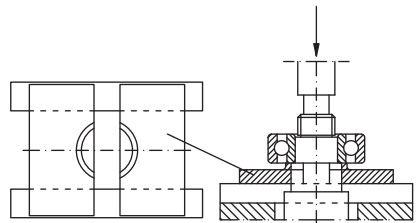

c

Fig. 7.17

To reduce the frictional force when dismounting large sized bearings which were mounted on shaft with tight fit, pressurized oil should be introduced, as in case of mounting - fig. 7.11.

To dismount bearings with tapered bore which were mounted directly on the shaft or bearings which were mounted with withdrawal or adapter sleeves, the nut axially fastened should be first stripped. Then, dismounting is to be done by light hammering on the inner ring by means of a soft steel or copper mandrel, as shown in fig. 7.18 a and b.

In case of bearings mounted with withdrawal sleeves, a nut is to be screwed up to the threaded



part provided for this purpose, as shown in fig. 7.19, a and b.

In case of large-sized bearings, hydraulic devices are used as in case of mounting.

Some solutions for dismounting bearings with tapered bore mounted directly on the shaft spindle, with adapter or withdrawal sleeve are given in fig. 7.20, a and b.

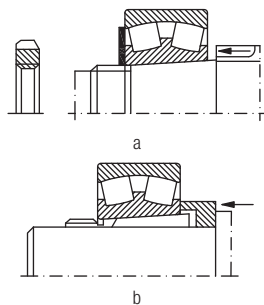

Fig. 7.18

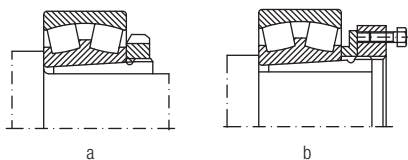

Fig. 7.19

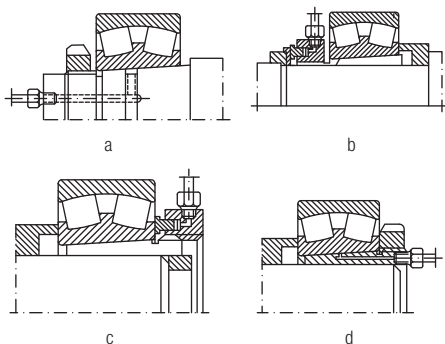
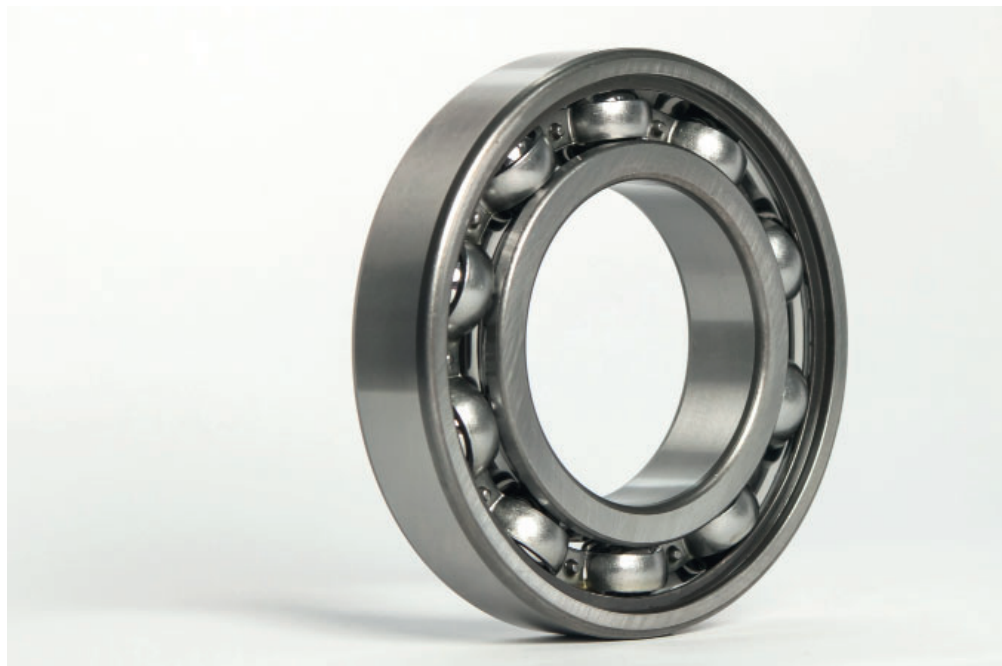

Fig. 7.20

# URB





# Deep groove ball bearings

Deep groove ball bearings are manufactured in a varied range, both of standard design and various constructive versions.

Deep groove ball bearings can take double direction radial and axial loads and also allow good operation at high speeds.

For these reasons, they can be widely used. Therefore, single row deep groove ball bearings are manufactured in many constructive versions as shown below.

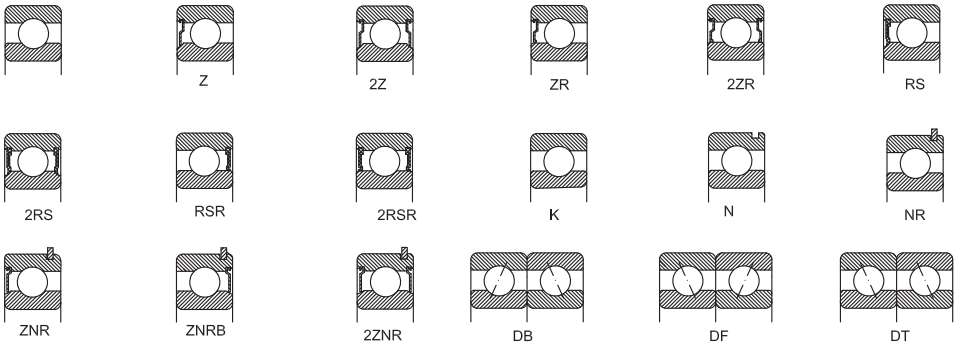

Besides deep groove ball bearings of basic design, bearings with UG design, with grooves on the outer ring and WL design, with grooves on both rings are also used for the purpose of mounting seals or shields on the bearings 2ZR, 2RSR or 2RS type, as shown in the bellow figure.

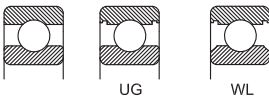

## Suffixes

- A** - bearing with extended outer ring
- B** - bearing with extended inner ring
- C2** - radial clearance smaller than normal
- C3** - radial clearance larger than normal
- FA** - machined cage of steel or cast iron guided in the outer ring
- F2** - constructive modifications

- K** - bearing with tapered bore
- M** - machined cage of brass guided on the rolling elements
- MA** - machined cage of brass guided in the outer ring
- MB** - machined cage of brass guided on the inner ring
- N** - circular groove for snap ring on the outer ring
- NR** - circular groove on the outer ring and snap ring
- P0** - normal tolerance class (it is not marked)
- P6** - tolerance class more accurate than normal
- P63** - tolerance class P6 and radial clearance C3
- P5** - tolerance class more accurate than P6
- P4** - tolerance class more accurate than P5
- R** - rib on the outer ring
- RS** - bearing with seal on the side, with friction on the inner ring recess
- RSA** - bearing with special seal



- 2RS** - bearing with 2 seals, friction on the inner ring recess
- RSR** - bearing with seal on one side, friction on the rib of the inner ring
- 2RSR** - bearing with 2 seals, friction on the rib of the inner ring
- S0** - bearing which can operate up to a temperature of +150°C
- S1** - bearing which can operate up to a temperature of +200°C
- SP** - snap ring, diameter series 0, 2, 3, 4
- SR** - snap ring, diameter series 18 and 19
- T30** - bearing which can operate up to a temperature of +300°C, radial clearance 0,20...0,25 mm; phosphate-treated surfaces
- TN** - polyamide cage
- V** - bearing without cage
- Z** - bearing with shield and recess on the inner ring
- ZZ** - bearing with 2 shields and recess on the inner ring
- ZNRB** - bearing with shield and snap ring on the same side
- ZR** - bearing with shield, without recess on the inner ring
- ZZR** - bearing with 2 shields, without recess on the inner ring

## Sealed and shielded deep groove ball bearings

URB manufactures two versions of sealed and shielded bearings, namely:

- bearings RS and Z type, with recess on the inner ring for sealing or shielding.
- bearings RSR and ZR type, when shielding and sealing respectively are done directly on the outside surface of the inner ring.

In case of bearings with non-rubbing shields, there is a small interstice between the shield and the rib of the inner ring; in case of bearings with seals, the gasoline and oil resistant elastic rubber lip rubs on the groove on the inner ring side or directly on the outside surface.

Bearings sealed and shielded on both sides manufactured in series are delivered filled with

lithium base grease and used at temperatures between -30°C and +110°C, in accordance with the specifications in chapter **Bearing lubrication**. Bearings can also be greased with special greases, relubrication not being necessary. Washing or heating are not allowed before bearing mounting in the assembly.

Bearings with shields have been designed first of all for cases when the inner ring rotates.

When the outer ring rotates, the lubricant can flow out of the bearing at a certain speed. In such cases, we recommend you to consult our experts.

## Deep groove ball bearings with the snap ring groove

Deep groove ball bearings, with snap ring groove on the outer ring can be located in the housing with snap rings.

Because of their simple and space saving mounting, these bearings simplify the assembly design. The groove for the snap ring and the snap rings are in accordance with ISO 464 and tables 7 and 8 respectively.

## Paired deep groove ball bearings

If the basic load of a single bearing is inadequate or the shaft has to be axially located in both directions with a certain clearance, paired deep groove ball bearings are recommended to be used.

These bearings can be delivered matched in pairs in three versions, as follows: DT (tandem arrangement), DB (back-to-back arrangement) or DF (face-to-face arrangement). They can be delivered with axial clearance or preloaded. The values of clearance or preload are given in table 2.

The producer marks "V" on the bearing outside surface as shown in next figure, so that pired bearings to be correctly mounted.

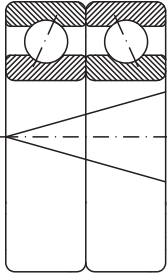

## Tolerances

Deep groove ball bearings are generally manufactured to the normal tolerance class P0.

At request, they can also be manufactured to the tolerance classes P6, P5 or P4.

The values of tolerances are given in chapter **Bearing tolerances** on page 26.

## Radial and axial clearance

Deep groove ball bearings are generally manufactured with normal radial clearance. At request, they can also be manufactured with radial clearance different from the normal one, according to ISO 5753. The values of radial clearance are given in table 1.

Paired bearings can be manufactured with axial clearance (suffix A) or preloaded (suffix L). Values for axial clearance and preload are given in table 2.

If a certain axial clearance is prescribed, this has to be measured and marked on the bearing by "A", followed by clearance actual value.

The multiple speed limit of these bearings can be calculated multiplying the speed of the basic bearing by 0,8.

Paired bearings are packed and delivered in the same box.

## Dimensions

The overall dimensions of deep groove ball bearings are in accordance with the stipulations of ISO 15.

## Misalignments

Deep groove ball bearings have limited abilities to compensate for bearing error of alignment. The permissible misalignment between the outer ring and the inner ring, which will not produce inadmissible high additional loads in the bearing, depends on the bearing size, operational radial clearance, inner bearing design and also on the magnitude of loads and moments acting upon the bearing.

Because of the complex relationship of these influence factors, definite and universally valid values of permissible misalignment cannot be determined. Considering the above mentioned factors, under normal operation conditions the permissible misalignments are between 2 and 10 minutes of arc, depending on the bearing series and load.



Radial clearance of deep groove ball bearings

Table 1

Bore diameter		Clearance group symbol for bearings with cylindrical bore									
d		C2		Normal		C3		C4		C5	
		Clearance group symbol for bearings with tapered bore									
		-		C2		Normal		C3		C4	
over	up to	min.	max.	min.	max.	min.	max.	min.	max.	min.	max.
mm		µm									
2.5	10	0	7	2	13	8	23	14	29	20	37
10	18	0	9	3	18	11	25	18	33	25	45
18	24	0	10	5	20	13	28	20	36	28	48
24	30	1	11	5	20	13	28	23	41	30	53
30	40	1	11	6	20	15	33	28	46	40	64
40	50	1	11	6	23	18	36	30	51	45	73
50	65	1	15	8	28	23	43	38	61	55	90
65	80	1	15	10	30	25	51	46	71	65	105
80	100	1	18	12	36	30	58	53	84	75	120
100	120	2	20	15	41	36	66	61	97	90	140
120	140	2	23	18	48	41	81	71	114	105	160
140	160	2	23	18	53	46	91	81	130	120	180
160	180	2	25	20	61	53	102	91	147	135	200
180	200	2	30	25	71	63	117	107	163	150	230
200	225	2	35	25	85	75	140	125	195	175	265
225	250	2	40	30	95	85	160	145	225	205	300
250	280	2	45	35	105	90	170	155	245	225	340
280	315	2	55	40	115	100	190	175	270	245	370
315	355	3	60	45	125	110	210	195	300	275	410
355	400	3	70	55	145	130	240	225	340	315	460
400	450	3	80	60	170	150	270	250	380	350	520
450	500	3	90	70	190	170	300	280	420	390	570
500	560	10	100	80	210	190	330	310	470	440	630
560	630	10	110	90	230	210	360	340	520	490	700
630	710	20	130	110	260	240	400	380	570	540	780
710	750	20	140	120	290	270	450	430	630	600	860

Axial clearance and mounting preload of paired bearings series 60, 62, 63

Table 2

Bore diameter d		Axial clearance (suffix A)		Preload (suffix L)		
over	up to	min.	max.	Bearing series		
				60	62	63
mm		µm		N		
-	10	15	35	30	30	-
10	18	20	40	50	50	100
18	30	25	45	100	100	100
30	50	35	55	100	100	200
50	80	40	70	200	200	350
80	120	50	80	300	400	600
120	180	60	100	500	700	900
180	250	70	110	800	1000	1200

### Cages

Deep groove ball bearings are generally fitted with cages of pressed steel sheet.

Cages of glass fiber reinforced polyamide 6.6 are also suitable if the operating temperature doesn't exceed +120°C. They have reduced mass, low coefficient of friction and are noiseless in operation. Large-sized bearings are fitted with machined brass cages.

Cage design and some technical data are given in table 3.







## Bearing minimum radial load

A minimum load must be applied on a deep groove ball bearing so that they can operate correctly, especially in case of operating under heavy loads.

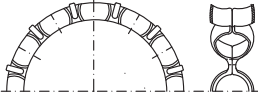
The forces of inertia which occur in bearing as well as the friction in lubricant influence negatively the operating conditions and can cause detrimental sliding movements between balls and raceways.

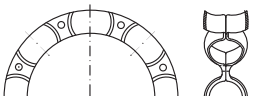
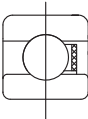
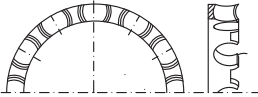
Table 3

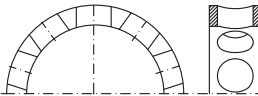
Cage	Design		Application	Max. value	
	bearing	cage		D <sub>n</sub>	
				oil	grease
Pressed cage of sheet with fins			<ul style="list-style-type: none"> <li>- General application</li> <li>- Bearings with d&gt;10 mm</li> <li>- Low frictional moment</li> <li>- Low inertia</li> <li>- Moderate speeds</li> </ul>	100x10 <sup>3</sup>	550x10 <sup>3</sup>
Pressed cage of riveted sheet			<ul style="list-style-type: none"> <li>- General application</li> <li>- Bearings with d&gt;10 mm</li> <li>- Low frictional moment</li> <li>- Low inertia</li> <li>- Moderate speeds</li> </ul>	1000x10 <sup>3</sup>	550x10 <sup>3</sup>
Polyamide cage			<ul style="list-style-type: none"> <li>- General application</li> <li>- Low frictional</li> <li>- High speeds</li> </ul>	1400x10 <sup>3</sup>	1100x10 <sup>3</sup>
Brass machined cage			<ul style="list-style-type: none"> <li>- General application</li> <li>- Bearings: <ul style="list-style-type: none"> <li>61836-618/1400</li> <li>61936-619/950</li> <li>16036-16072</li> <li>6030-60/630</li> <li>6230-6248</li> <li>6320-6330</li> </ul> </li> </ul>	1000x10 <sup>3</sup>	800x10 <sup>3</sup>

Minimum radial load depends on the bearing size, speed and lubricant viscosity at operating temperature. It can be roughly calculated from the equation:

$$F_{r \min} = 0,01 C_r (C_r = \text{basic dynamic radial load}).$$

## Equivalent dynamic radial load

Deep groove ball bearing can take also radial and axial combined loads.

For deep groove ball bearings, single or paired in tandem arrangement DT, equivalent dynamic radial load can be calculated using the equation:

$$P_r = F_r, \text{ kN, when } F_a/F_r < e$$

$$P_r = X F_r + Y F_a, \text{ kN, when } F_a/F_r > e$$

The greater the axial load, the greater the contact angle of these bearings.

Factor e, X and Y depend on the ratio  $f_0 F_a / C_{0r}$ .

Factor  $f_0$  can be determined using the diagram in the bellow figure, as a function of dimension series and mean diameter  $(d+D)/2$ .  $F_a$  is the axial and  $C_{0r}$  is the static basic load of the bearing.

The values of factors e, X, Y which depend on the bearing clearance can be determined from table 4, corresponding to the values of the ratio  $f_0 F_a / C_{0r}$ . The values in table 4 apply to bearings mounted with normal fit, i.e. shaft manufactured to tolerance class j5 or k5 and housing in J6, respectively.

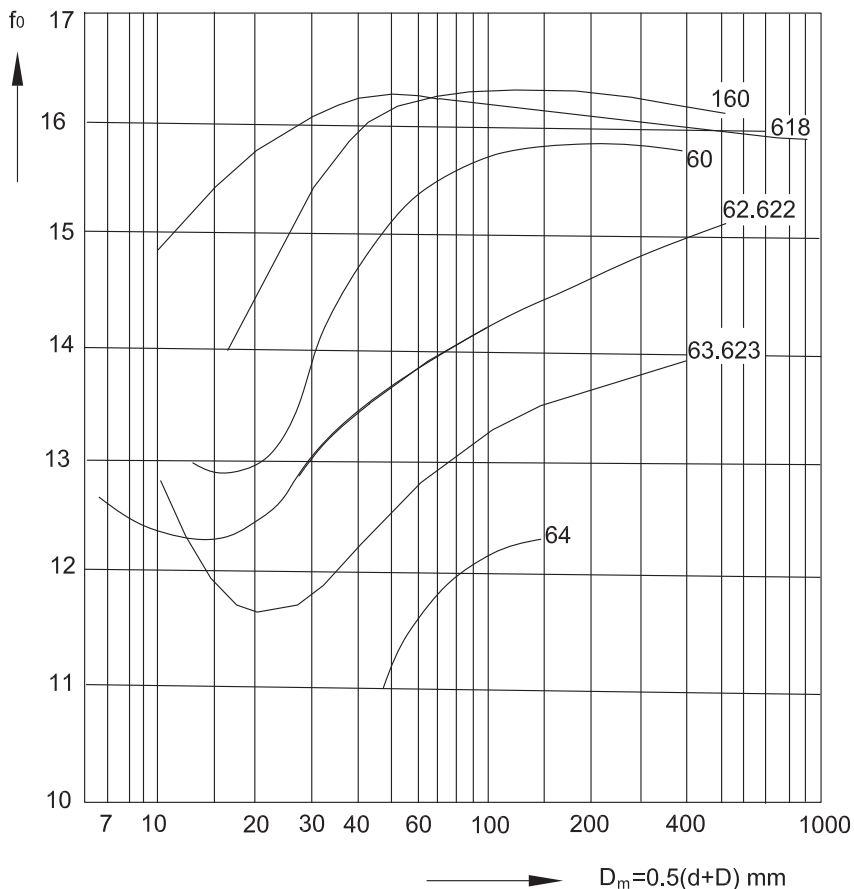

Calculation factors e, X and Z for deep groove ball bearings, single mounted or matched in tandem

Table 4

$f \frac{F}{C_{Or}}$	Normal radial clearance			Radial clearance C3			Radial clearance C4		
	e	X	Y	e	X	Y	e	X	Y
<b>0,2</b>	0,19	0,56	2,25	0,32	0,46	1,77	0,38	0,44	1,44
<b>0,4</b>	0,22	0,56	1,95	0,34	0,46	1,63	0,42	0,44	1,36
<b>0,8</b>	0,26	0,56	1,68	0,38	0,46	1,44	0,45	0,44	1,25
<b>1,6</b>	0,31	0,56	1,4	0,43	0,46	1,27	0,48	0,44	1,16
<b>3</b>	0,37	0,56	1,2	0,48	0,46	1,14	0,52	0,44	1,08
<b>6</b>	0,44	0,56	1,02	0,54	0,46	1	0,56	0,44	1

For bearings matched in DB or DT arrangement, equivalent dynamic radial load can be calculated using the equation:

$$P_r = F_r + Y_1 F_a, \text{ kN when } F_a/F_r < e$$

$$P_r = 0,75 F_r + Y_2 F_a, \text{ kN when } F_a/F_r > e.$$

The values of factors  $e$ ,  $Y_1$  and  $Y_2$ , as functions of ratio  $F_a/C_{0r}$  are given in table 5.

Calculation factors $e$ , $Y_1$ , $Y_2$ for DB and DF arrangements			
$f_0 F_a/C_{0r}$	$e$	$Y_1$	$Y_2$
0,03	0,32	2	2,8
0,1	0,4	1,55	2,2
0,25	0,47	3	1,65

### Equivalent static radial load

For deep groove ball bearings, single or matched in tandem (DT), equivalent static load can be calculated using the equations:

$$P_0 = F_r, \text{ kN, when } F_a/F_r < 0,8$$

$$P_0 = 0,6 F_r + 0,5 F_a, \text{ kN, when } F_a/F_r > 0,8$$

For bearings matched in DB or DF arrangement, it can be calculated from

$$P_0 = F_r + 1,7 F_a, \text{ kN.}$$

### Axial load

If deep groove ball bearings are pure axial loaded, the axial load should not exceed  $0,5 C_{0r}$ . In case of small-sized bearings and bearings of light series (diameter series 8, 9, 0 and 1), the axial load should not exceed  $0,25 C_{0r}$ .

Heavy axial loads cause a significant decrease of bearing rating life. In such cases, we recommend you to consult our experts.

### Abutment dimensions

For a proper location of bearing rings on the shaft shoulder and housing, respectively, maximum shaft (housing) connection radius  $r_u$  max should be less than minimum bearing mounting chamfer  $r_s$  min.

The shoulder should have the proper height corresponding to maximum bearing mounting chamfer.

The values of the connection radius ( $r_u$ ) and support shoulder height ( $h_u$ ) as function of mounting chamfers are given in table 6.

Abutment dimension				
$r_s$ min	$r_u$ max	$h_u$ min		
		Bearing series		
		618	161, 60,	64
		619, 160	62, 63	
0,15	0,15	0,4	0,7	-
0,2	0,2	0,7	0,9	-
0,3	0,3	1	1,2	-
0,6	0,6	1,6	2,1	-
1	1	2,3	2,8	-
1,1	1	3	3,5	4,5
1,5	1,5	3,5	4,5	5,5
2	2	4,4	5,5	6,5
2,1	2,1	5,1	6	7
3	2,5	6,2	7	8
4	3	7,3	8,5	10
5	4	9	10	12
6	5	11,5	13	15
7,5	6	14	-	-

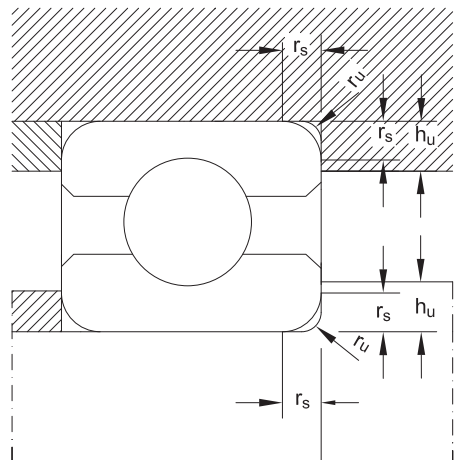

## Snap ring groove and snap ring dimensions and tolerances

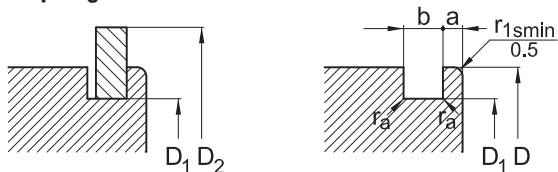

Snap ring groove <span style="float: right;">Table 7</span>										
Outer diameter D	Dimensions series									
	18		19							
	D <sub>1</sub>		a		a		b		r <sub>o</sub>	
nom.	toler.	nom.	toler.	nom.	toler.	nom.	toler.	nom.	toler.	
mm										
22	20,8	-0,3	-	-	1,05	-0,15	0,8	+0,25	0,2	-0,1
24	22,8	-0,3	-	-	1,05	-0,15	0,8	+0,25	0,2	-0,1
28	26,7	-0,3	-	-	1,3	-0,15	0,95	+0,25	0,25	-0,12
30	28,7	-0,3	-	-	1,3	-0,15	0,95	+0,25	0,25	-0,12
32	30,7	-0,3	1,3	-0,15	-	-	0,95	+0,25	0,25	-0,12
34	32,7	-0,3	1,3	-0,15	-	-	0,95	+0,25	0,25	-0,12
37	35,7	-0,3	1,3	-0,15	1,7	-0,15	0,95	+0,25	0,25	-0,12
39	37,7	-0,3	-	-	1,7	-0,15	0,95	+0,25	0,25	-0,12
40	38,7	-0,3	1,3	-0,15	-	-	0,95	+0,25	0,25	-0,12
42	40,7	-0,3	1,3	-0,15	1,7	-0,15	0,95	+0,25	0,25	-0,12
44	42,7	-0,3	1,3	-0,15	-	-	0,95	+0,25	0,25	-0,12
45	43,7	-0,3	-	-	1,7	-0,15	0,95	+0,25	0,25	-0,12
47	45,7	-0,3	1,3	-0,15	1,7	-0,15	0,95	+0,25	0,25	-0,12
52	50,7	-0,3	1,3	-0,15	1,7	-0,15	0,95	+0,25	0,25	-0,12
55	53,7	-0,3	-	-	1,7	-0,15	0,95	+0,25	0,25	-0,12
58	56,7	-0,3	1,3	-0,15	-	-	0,95	+0,25	0,25	-0,12
62	60,7	-0,3	-	-	1,7	-0,15	0,95	+0,25	0,25	-0,12
65	63,7	-0,4	1,3	-0,15	-	-	0,95	+0,25	0,25	-0,12
68	66,7	-0,4	-	-	1,7	-0,15	0,95	+0,25	0,25	-0,12
72	70,7	-0,4	1,7	-0,15	1,7	-0,15	0,95	+0,25	0,25	-0,12
78	76,2	-0,4	1,7	-0,15	-	-	1,3	+0,3	0,4	-0,2
80	77,9	-0,4	-	-	2,1	-0,2	1,3	+0,3	0,4	-0,2
85	82,9	-0,4	1,7	-0,15	2,1	-0,2	1,3	+0,3	0,4	-0,2
90	87,9	-0,4	1,7	-0,15	2,1	-0,2	1,3	+0,3	0,4	-0,2
95	92,9	-0,4	1,7	-0,15	-	-	1,3	+0,3	0,4	-0,2
100	97,9	-0,4	1,7	-0,15	2,5	-0,2	1,3	+0,3	0,4	-0,2
105	102,6	-0,5	-	-	2,5	-0,2	1,3	+0,3	0,4	-0,2
110	107,6	-0,5	2,1	-0,2	2,5	-0,2	1,3	+0,3	0,4	-0,2
115	112,6	-0,5	2,1	-0,2	-	-	1,3	+0,3	0,4	-0,2
120	117,6	-0,5	2,1	-0,2	3,3	-0,2	1,3	+0,3	0,4	-0,2
125	122,6	-0,5	2,1	-0,2	3,3	-0,2	1,3	+0,3	0,4	-0,2
130	127,6	-0,5	2,1	-0,2	3,3	-0,2	1,3	+0,3	0,4	-0,2
140	137,6	-0,5	2,5	-0,2	3,3	-0,2	1,9	+0,3	0,6	-0,2
145	142,7	-0,5	-	-	3,3	-0,2	1,9	+0,3	0,6	-0,3
150	147,6	-0,5	2,5	-0,2	3,3	-0,2	1,9	+0,3	0,6	-0,3
165	161,8	-0,5	3,3	-0,2	3,7	-0,2	1,9	+0,3	0,6	-0,3
175	171,8	-0,5	3,3	-0,2	-	-	1,9	+0,3	0,6	-0,3
180	176,8	-0,5	-	-	3,7	-0,2	1,9	+0,3	0,6	-0,3
190	186,8	-0,5	3,3	-0,2	3,7	-0,2	1,9	+0,3	0,6	-0,3
200	196,8	-0,5	3,3	-0,2	-	-	1,9	+0,3	0,6	-0,3

The outer ring chamfer on the side of snap ring groove should allow a housing connection radius of: 0,3 mm for dimensions series 18, up to D = 78 mm included and for dimensions series 19, up to D = 47 mm included; 0,5 mm for dimensions series 18, for D > 78 mm and for dimensions series 19, for D > 47 mm

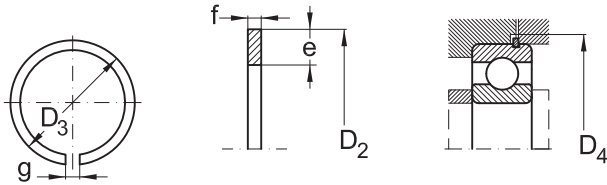

**Snap ring**

Table 7 (continue)

Outer diameter D	D <sub>2</sub> <sup>1)</sup>		D <sub>3</sub> <sup>2)</sup>		D <sub>4</sub>	e	f	g	r	Mass	Snap ring designation
	max.	nom.	nom.	toler.	min.	nom.	nom.	nom.	min.		
mm										g	-
<b>22</b>	24,8	20,5	-0,3	25	2	0,7	2	0,2	0,812	<b>SR22</b>	
<b>24</b>	26,8	22,5	-0,3	28	2	0,7	2	0,2	0,886	<b>SR24</b>	
<b>28</b>	30,8	26,4	-0,3	32	2,05	0,85	3	0,2	1,269	<b>SR28</b>	
<b>30</b>	32,8	28,3	-0,3	34	2,05	0,85	3	0,2	1,39	<b>SR30</b>	
<b>32</b>	34,8	30,3	-0,3	36	2,05	0,85	3	0,2	1,483	<b>SR32</b>	
<b>34</b>	36,8	32,3	-0,3	38	2,05	0,85	3	0,2	1,577	<b>SR34</b>	
<b>37</b>	39,8	35,3	-0,3	41	2,05	0,85	3	0,2	1,718	<b>SR37</b>	
<b>39</b>	41,8	37,3	-0,3	43	2,05	0,85	3	0,2	1,811	<b>SR39</b>	
<b>40</b>	42,8	38,3	-0,3	44	2,05	0,85	3	0,2	1,858	<b>SR40</b>	
<b>42</b>	44,8	40,3	-0,4	46	2,05	0,85	3	0,2	1,952	<b>SR42</b>	
<b>44</b>	46,8	42,3	-0,4	48	2,05	0,85	4	0,2	2,032	<b>SR44</b>	
<b>45</b>	47,8	43,3	-0,4	49	2,05	0,85	4	0,2	2,079	<b>SR45</b>	
<b>47</b>	49,8	45,3	-0,4	51	2,05	0,85	4	0,2	2,173	<b>SR47</b>	
<b>52</b>	54,8	50,3	-0,4	56	2,05	0,85	4	0,2	2,407	<b>SR52</b>	
<b>55</b>	57,8	53,3	-0,4	59	2,05	0,85	4	0,2	2,547	<b>SR55</b>	
<b>58</b>	60,8	56,3	-0,6	62	2,05	0,85	4	0,2	2,688	<b>SR58</b>	
<b>62</b>	64,8	60,2	-0,6	66	2,05	0,85	4	0,2	2,938	<b>SR62</b>	
<b>65</b>	67,8	63,2	-0,6	69	2,05	0,85	4	0,2	3,081	<b>SR65</b>	
<b>68</b>	70,8	66,2	-0,6	72	2,05	0,85	5	0,2	3,212	<b>SR68</b>	
<b>72</b>	74,8	70,2	-0,6	76	2,05	0,85	5	0,2	3,403	<b>SR72</b>	
<b>78</b>	82,7	75,7	-0,6	84	3,25	1,12	5	0,4	7,462	<b>SR78</b>	
<b>80</b>	84,4	77,4	-0,6	86	3,25	1,12	5	0,4	7,625	<b>SR80</b>	
<b>85</b>	89,4	82,4	-0,6	91	3,25	1,12	5	0,4	8,105	<b>SR85</b>	
<b>90</b>	94,4	87,4	-0,6	96	3,25	1,12	5	0,4	8,585	<b>SR90</b>	
<b>95</b>	99,4	92,4	-0,6	101	3,25	1,12	5	0,4	9,065	<b>SR95</b>	
<b>100</b>	104,4	97,4	-0,6	106	3,25	1,12	5	0,4	9,545	<b>SR100</b>	
<b>105</b>	110,7	101,9	-0,8	112	4,04	1,12	5	0,4	12,653	<b>SR105</b>	
<b>110</b>	115,7	106,9	-0,8	117	4,04	1,12	5	0,4	13,257	<b>SR110</b>	
<b>115</b>	120,7	111,9	-0,8	122	4,04	1,12	5	0,4	13,861	<b>SR115</b>	
<b>120</b>	125,7	116,9	-0,8	127	4,04	1,12	7	0,4	14,393	<b>SR120</b>	
<b>125</b>	130,7	121,8	-0,8	132	4,04	1,12	7	0,4	15,164	<b>SR125</b>	
<b>130</b>	135,7	126,8	-0,8	137	4,04	1,12	7	0,4	15,774	<b>SR130</b>	
<b>140</b>	145,7	136,8	-1	147	4,04	1,7	7	0,4	25,796	<b>SR140</b>	
<b>145</b>	150,7	141,8	-1	152	4,04	1,7	7	0,6	26,722	<b>SR145</b>	
<b>150</b>	155,7	146,8	-1,2	157	4,04	1,7	7	0,6	27,648	<b>SR150</b>	
<b>165</b>	171,5	161	-1,2	173	4,85	1,7	7	0,6	35,89	<b>SR165</b>	
<b>175</b>	181,5	171	-1,2	183	4,85	1,7	10	0,6	37,883	<b>SR175</b>	
<b>180</b>	186,5	176	-1,2	187	4,85	1,7	10	0,6	38,976	<b>SR180</b>	
<b>190</b>	196,5	186	-1,4	198	4,85	1,7	10	0,6	41,162	<b>SR190</b>	
<b>200</b>	206,5	196	-1,4	208	4,85	1,7	10	0,6	43,348	<b>SR200</b>	

<sup>1)</sup> D<sub>2</sub> dimensions refers to the mounted snap ring

<sup>2)</sup> D<sub>3</sub> represents dimensions before mounting



### Snap ring groove and snap ring dimensions and tolerances

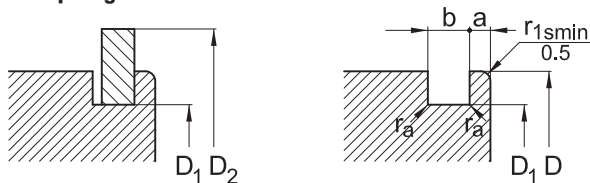

Snap ring groove <span style="float: right;">Table 8</span>										
Outer diameter D	Dimensions series									
	60		62, 63, 64							
	D <sub>1</sub>		a		a		b		r <sub>o</sub>	
	nom.	toler.	nom.	toler.	nom.	toler.	nom.	toler.	nom.	toler.
mm										
30	28,17	-0,25	-	-	2,06	-0,16	1,35	+0,3	0,4	-0,2
32	30,15	-0,25	2,06	-0,16	2,06	-0,16	1,35	+0,3	0,4	-0,2
35	33,17	-0,25	2,06	-0,16	2,06	-0,16	1,35	+0,3	0,4	-0,2
40	38,1	-0,25			2,06	-0,16	1,35	+0,3	0,4	-0,2
42	39,75	-0,25	2,06	-0,16	2,06	-0,16	1,35	+0,3	0,4	-0,2
47	44,6	-0,25	2,06	-0,16	2,46	-0,15	1,35	+0,3	0,4	-0,2
52	49,73	-0,25	2,06	-0,16	2,46	-0,15	1,35	+0,3	0,4	-0,2
55	52,6	-0,25	2,08	-0,2	-	-	1,35	+0,3	0,4	-0,2
62	59,61	-0,5	2,08	-0,2	3,28	-0,21	1,9	+0,3	0,6	-0,3
68	64,82	-0,5	2,49	-0,2	3,28	-0,21	1,9	+0,3	0,6	-0,3
72	68,81	-0,5	-	-	3,28	-0,21	1,9	+0,3	0,6	-0,3
75	71,83	-0,5	2,49	-0,2	3,28	-0,21	1,9	+0,3	0,6	-0,3
80	76,81	-0,5	2,49	-0,2	3,28	-0,21	1,9	+0,3	0,6	-0,3
85	81,81	-0,5	-	-	3,28	-0,21	1,9	+0,3	0,6	-0,3
90	86,79	-0,5	2,87	-0,2	3,28	-0,21	2,7	+0,3	0,6	-0,3
95	91,82	-0,5	2,87	-0,2	-	-	2,7	+0,3	0,6	-0,3
100	96,8	-0,5	2,87	-0,2	3,28	-0,21	2,7	+0,3	0,6	-0,3
110	106,81	-0,5	2,87	-0,2	3,28	-0,21	2,7	+0,3	0,6	-0,3
115	111,81	-0,5	2,87	-0,2	-	-	2,7	+0,3	0,6	-0,3
120	115,21	-0,5	-	-	4,06	-0,21	3,1	+0,3	0,6	-0,3
125	120,22	-0,5	2,87	-0,2	4,06	-0,2	3,1	+0,3	0,6	-0,3
130	125,22	-0,5	2,87	-0,2	4,06	-0,2	3,1	+0,3	0,6	-0,3
140	135,23	-0,5	3,71	-0,26	4,9	-0,25	3,1	+0,3	0,6	-0,3
145	140,23	-0,5	3,71	-0,26	-	-	3,1	+0,3	0,6	-0,3
150	145,24	-0,5	3,71	-0,26	4,9	-0,25	3,1	+0,3	0,6	-0,3
160	155,22	-0,5	3,71	-0,26	4,9	-0,25	3,1	+0,3	0,6	-0,3
170	163,65	-0,5	3,71	-0,26	5,69	-0,25	3,5	+0,3	0,6	-0,3
180	173,66	-0,5	3,71	-0,26	5,69	-0,25	3,5	+0,3	0,6	-0,3
200	193,65	-0,5	5,69	-0,25	5,69	-0,25	3,5	+0,3	0,6	-0,3

The outer ring chamfer on the side of snap ring groove should allow a housing connection radius of: 0,3 mm for dimensions series 18, up to D = 78 mm included and for dimensions series 19, up to D = 47 mm included; 0,5 mm for dimensions series 18, for D > 78 mm and for dimensions series 19, for D > 47 mm

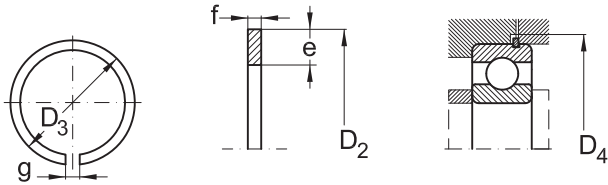

Snap ring

Table 8 (continue)

Outer diameter D	D <sub>2</sub> <sup>1)</sup>	D <sub>3</sub> <sup>2)</sup>		D <sub>4</sub>	e	f	g	r	Mass	Snap ring designation
	max.	nom.	toler.	min.	nom.	nom.	nom.	min.		
mm									g	-
30	34,7	27,9	-0,4	36	3,25	1,12	3	0,4	2,78	SP30
32	36,7	29,9	-0,4	38	3,25	1,12	3	0,4	2,98	SP32
35	39,7	32,9	-0,4	41	3,25	1,12	3	0,4	3,22	SP35
40	44,6	37,8	-0,4	46	3,25	1,12	3	0,4	3,6	SP40
42	46,3	39,5	-0,5	47	3,25	1,12	3	0,4	3,75	SP42
47	52,7	44,3	-0,5	54	4,04	1,12	4	0,4	5,3	SP47
52	57,9	49,4	-0,5	59	4,04	1,12	4	0,4	5,92	SP52
55	60,7	52,3	-0,5	62	4,04	1,12	4	0,4	6,17	SP55
62	67,7	59	-0,6	69	4,04	1,7	4	0,6	10,5	SP62
68	74,6	64,2	-0,6	76	4,85	1,7	5	0,6	12,6	SP68
72	78,6	68,2	-0,6	80	4,85	1,7	5	0,6	14,7	SP72
75	81,6	71,2	-0,6	83	4,85	1,7	5	0,6	15,3	SP75
80	86,6	76,2	-0,6	88	4,85	1,7	5	0,6	16,3	SP80
85	91,6	81,2	-0,6	93	4,85	1,7	5	0,6	17,5	SP85
90	96,5	86,2	-0,6	98	4,85	2,46	5	0,6	26,6	SP90
95	101,6	91,2	-0,6	103	4,85	2,46	5	0,6	28,2	SP95
100	106,5	96,2	-0,8	108	4,85	2,46	5	0,6	29,2	SP100
110	116,6	106,2	-0,8	118	4,85	2,46	5	0,6	32,8	SP110
115	121,6	111,2	-0,8	123	4,85	2,46	5	0,6	34,4	SP115
120	129,7	114,6	-0,8	131	7,21	2,82	7	0,6	60,6	SP120
125	134,7	119,6	-0,8	136	7,21	2,82	7	0,6	63	SP125
130	139,7	124,6	-0,8	141	7,21	2,82	7	0,6	65,6	SP130
140	149,7	134,6	-1,2	151	7,21	2,82	7	0,6	70,6	SP140
145	154,7	139,6	-1,2	156	7,21	2,82	7	0,6	73	SP145
150	159,7	144,5	-1,2	161	7,21	2,82	7	0,6	77,2	SP150
160	169,7	154,5	-1,2	172	7,21	2,82	7	0,6	81	SP160
170	182,9	162,9	-1,2	185	9,6	3,1	10	0,6	122	SP170
180	192,9	172,8	-1,2	195	9,6	3,1	10	0,6	128	SP180
200	212,9	192,8	-1,4	215	9,6	3,1	10	0,6	148	SP200

<sup>1)</sup> D<sub>2</sub> dimensions refers to the mounted snap ring  
<sup>2)</sup> D<sub>3</sub> represents dimensions before mounting



### Single Row Deep Groove Ball Bearings

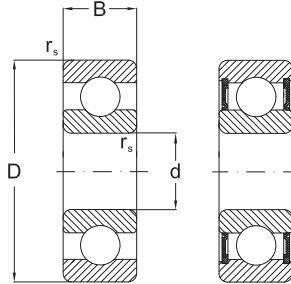

2RSR

d	Dimensions			Basical radial load		Speed limit		Designation		Mass
	D	B	r <sub>s</sub> min	dyn. C <sub>r</sub>	stat. C <sub>0r</sub>	grease	oil	bearing	snap ring	
mm			kN		min <sup>-1</sup>		-		kg	
3	10	4	0,1	0,64	0,23	40000	48000	<b>623</b>		0,002
	10	4	0,1	0,64	0,23	40000		<b>623 2ZR</b>		0,002
4	13	5	0,2	1,3	0,49	38000	45000	<b>624</b>		0,003
	13	5	0,2	1,3	0,49	38000		<b>624 2ZR</b>		0,003
	16	5	0,3	1,2	0,5	34000	40000	<b>634</b>		0,005
	16	5	0,3	1,2	0,5	34000		<b>634 2ZR</b>		0,005
5	11	3	0,1	0,64	0,26	55000	65000	<b>618/5</b>		0,001
	16	5	0,3	1,9	0,69	34000	40000	<b>625</b>		0,005
	16	5	0,3	1,9	0,69	34000		<b>625 2ZR</b>		0,005
	16	5	0,3	1,9	0,69	22000		<b>625 2RSR</b>		0,005
	19	6	0,3	1,7	0,72	32000	38000	<b>635</b>		0,009
	19	6	0,3	1,7	0,72	32000		<b>635 2ZR</b>		0,009
6	13	3,5	0,1	1	0,44	50000	59000	<b>618/6</b>		0,002
	15	5	0,2	1,45	0,6	47000	56000	<b>619/6</b>		0,004
	19	6	0,3	2,2	0,89	32000	38000	<b>626</b>		0,008
	19	6	0,3	2,2	0,89	32000		<b>626 2ZR</b>		0,008
	19	6	0,3	2,2	0,89	22000		<b>626 2RSR</b>		0,008
7	14	3,5	0,1	0,96	0,4	47000	56000	<b>618/7</b>		0,002
	17	5	0,3	2,1	0,8	44000	51000	<b>619/7 Y</b>		0,005
	19	6	0,3	2,25	0,89	32000	38000	<b>607</b>		0,008
	19	6	0,3	2,25	0,89	32000		<b>607 2ZR</b>		0,008
	19	6	0,3	2,25	0,89	22000		<b>607 2RSR</b>		0,008
	22	7	0,3	3,3	1,35	30000	36000	<b>627</b>		0,012
	22	7	0,3	3,3	1,35	30000		<b>627 2ZR</b>		0,012
	22	7	0,3	3,3	1,35	20000		<b>627 2RSR</b>		0,012
8	16	4	0,2	1,35	0,57	44000	51000	<b>618/8</b>		0,003
	19	6	0,3	1,6	0,74	40000	47000	<b>619/8</b>		0,007
	22	7	0,3	3,3	1,35	30000	36000	<b>608</b>		0,015
	22	7	0,3	3,3	1,35	30000		<b>608 2ZR</b>		0,015
	22	7	0,3	3,3	1,35	20000		<b>608 2RSR</b>		0,015
9	17	4	0,2	1,45	0,64	40000	47000	<b>618/9</b>		0,003
	20	6	0,3	2,65	1,1	37000	43000	<b>619/9</b>		0,007
	24	7	0,3	3,35	1,4	30000	36000	<b>609</b>		0,018
	24	7	0,3	3,35	1,4	30000		<b>609 2ZR</b>		0,018



## Single Row Deep Groove Ball Bearings

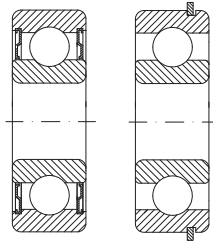

2ZR

NR

Dimensions				Basical radial load		Speed limit		Designation		Mass
d	D	B	$r_s$ min	dyn. $C_r$	stat. $C_{0r}$	grease	oil	bearing	snap ring	
mm				kN		min <sup>-1</sup>		-		kg
9	24	7	0,3	3,35	1,4	20000		<b>609 2RSR</b>		0,018
	26	8	0,3	4,55	1,95	28000	34000	<b>629</b>		0,02
	26	8	0,3	4,55	1,95	28000		<b>629 2ZR</b>		0,02
	26	8	0,3	4,55	1,95	18000		<b>629 2RSR</b>		0,02
10	19	5	0,3	1,7	0,83	37000	43000	<b>61800</b>		0,005
	22	6	0,3	1,95	0,75	34000	41000	<b>61900 TN</b>		0,01
	26	8	0,3	4,6	1,95	28000	34000	<b>6000 TN</b>		0,02
	26	8	0,3	4,6	1,95	28000		<b>6000 2ZR</b>		0,02
	26	8	0,3	4,6	1,95	17000		<b>6000 2RSR</b>		0,02
	28	8	0,3	4,6	1,95	28000	34000	<b>16100</b>		0,023
	30	9	0,6	5,1	2,4	26000	32000	<b>6200 TN</b>		0,032
	30	9	0,6	5,1	2,4	26000		<b>6200 2ZR</b>		0,032
	30	9	0,6	5,1	2,4	17000		<b>6200 2RSR</b>		0,032
	30	14	0,6	5,1	2,4	17000		<b>62200 2RSR</b>		0,047
	35	11	0,6	8,1	3,45	20000	26000	<b>6300</b>		0,057
	35	11	0,6	8,2	3,5	20000		<b>6300 2ZR</b>		0,057
	35	11	0,6	8,2	3,5	15000		<b>6300 2RSR</b>		0,057
	35	17	0,6	8,2	3,5	10000		<b>62300 2RSR</b>		0,063
12	21	5	0,3	1,8	0,95	33000	39000	<b>61801</b>		0,006
	21	5	0,3	1,45	0,67	33000	39000	<b>61801 NR</b>	SR21	0,006
	24	6	0,3	2,9	1,45	31000	36000	<b>61901</b>		0,011
	24	6	0,3	2,9	1,45	31000	36000	<b>61901 NR</b>	SR24	0,011
	28	8	0,3	5,1	2,4	26000	32000	<b>6001</b>		0,022
	28	8	0,3	5,1	2,4	26000	32000	<b>6001 TN</b>		0,022
	28	8	0,3	5,1	2,4	26000		<b>6001 2ZR</b>		0,022
	28	8	0,3	5,1	2,4	17000		<b>6001 2RSR</b>		0,022
	30	8	0,3	5,1	2,4	26000	32000	<b>16101</b>		0,026
	32	10	0,6	6,9	3,1	22000	28000	<b>6201</b>		0,037
	32	10	0,6	6,9	3,1	22000	28000	<b>6201 TN</b>		0,037
	32	10	0,6	6,9	3,1	22000		<b>6201 2ZR</b>		0,037
	32	10	0,6	6,9	3,1	15000		<b>6201 2RSR</b>		0,037
	32	14	0,6	6,9	3,1	22000		<b>62201 2RSR</b>		0,049
	37	12	1	9,8	4,2	19000	24000	<b>6301</b>		0,065
	37	12	1	9,8	4,2	19000		<b>6301 2ZR</b>		0,065
37	12	1	9,8	4,2	12000		<b>6301 2RSR</b>		0,065	



### Single Row Deep Groove Ball Bearings

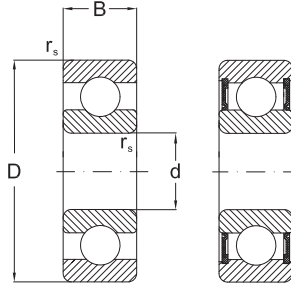

2RSR

d	Dimensions			Basical radial load		Speed limit		Designation		Mass	
	D	B	$r_s$ min	dyn. $C_r$	stat. $C_{0r}$	grease	oil	bearing	snap ring		
mm			kN		min <sup>-1</sup>		-		kg		
12	37	17	1	9,8	4,2	12000		<b>62301 2RSR</b>		0,07	
	24	5	0,3	2	1,25	28000	33000	<b>61802</b>		0,007	
	24	5	0,3	2	1,25	28000	33000	<b>61802 NR</b>	SR24	0,007	
	28	7	0,3	4	2,05	26000	30000	<b>61902</b>		0,017	
	28	7	0,3	4	2,05	26000	30000	<b>61902 NR</b>	SR28	0,017	
	30	8	0,3	4	2,05	22000	28000	<b>16002</b>		0,037	
	32	9	0,3	5,6	2,9	22000	28000	<b>6002</b>		0,031	
	32	9	0,3	5,6	2,9	22000		<b>6002 2ZR</b>		0,031	
	32	9	0,3	5,6	2,9	14000		<b>6002 2RSR</b>		0,031	
	15	35	11	0,6	7,8	3,8	19000	24000	<b>6202</b>		0,046
		35	11	0,6	7,8	3,8	19000		<b>6202 2ZR</b>		0,046
		35	11	0,6	7,65	3,75	19000	24000	<b>6202 TN</b>		0,046
35		11	0,6	7,8	3,8	13000		<b>6202 2RSR</b>		0,046	
35		14	0,6	7,8	3,8	13000		<b>62202 2RSR</b>		0,053	
42		13	1	11,5	5,5	17000	20000	<b>6302</b>		0,092	
42		13	1	11,5	5,5	17000		<b>6302 2ZR</b>		0,092	
42		13	1	11,5	5,5	11000		<b>6302 2RSR</b>		0,092	
42		17	1	11,5	5,5	17000		<b>62302 2RSR</b>		0,099	
17		26	5	0,3	2,2	1,4	26000	32000	<b>61803</b>		0,009
	30	7	0,3	4,35	2,3	26000	30000	<b>61903</b>		0,018	
	35	8	0,3	6	3,25	20000	26000	<b>16003</b>		0,04	
	35	10	0,3	6	3,3	20000	26000	<b>6003</b>		0,042	
	35	10	0,3	6	3,3	20000		<b>6003 2ZR</b>		0,042	
	35	10	0,3	6	3,3	12000		<b>6003 2RSR</b>		0,042	
	40	12	0,6	9,6	4,8	17000	20000	<b>6203</b>		0,07	
	40	12	0,6	9,6	4,8	17000	20000	<b>6203 TN</b>		0,07	
	40	12	0,6	9,6	4,8	17000		<b>6203 2ZR</b>		0,07	
	40	12	0,6	9,6	4,8	11000		<b>6203 2RSR</b>		0,07	
	40	12	0,6	9,6	4,8	17000	20000	<b>6203 NR</b>	SP40	0,07	
	40	16	1	9,6	4,8	17000		<b>62203 2RSR</b>		0,082	
	47	14	1	13,7	6,7	16000	19000	<b>6303</b>		0,12	
	47	14	1	13,7	6,7	16000		<b>6303 2ZR</b>		0,12	
	47	14	1	13,7	6,7	10000		<b>6303 2RSR</b>		0,12	
	47	19	1	13,4	6,55	16000		<b>62303 2RSR</b>		0,145	
62	17	1,1	22,7	11	12000	15000	<b>6403</b>		0,285		

## Single Row Deep Groove Ball Bearings

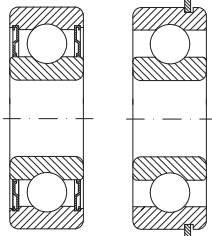

2ZR

NR

d	Dimensions			Basic radial load		Speed limit		Designation		Mass
	D	B	$r_s$ min	dyn. $C_r$	stat. $C_{0r}$	grease	oil	bearing	snap ring	
mm				kN		min <sup>-1</sup>		-		kg
17	62	17	1,1	22,7	11	12000	15000	<b>6403 NR</b>	SP62	0,285
	32	7	0,3	3,45	2,25	20000	26000	<b>61804</b>		0,02
	32	7	0,3	3,45	2,25	20000	26000	<b>61804 NR</b>	SR32	0,02
	37	9	0,3	6,55	3,65	19000	23000	<b>61904</b>		0,036
	37	9	0,3	6,55	3,65	19000	23000	<b>61904 NR</b>	SR37	0,036
	42	8	0,3	7,95	4,5	17000	20000	<b>16004</b>		0,05
	42	12	0,6	9,4	5,1	17000	20000	<b>6004</b>		0,07
	42	12	0,6	9,4	5,1	17000		<b>6004 2ZR</b>		0,07
	42	12	0,6	9,4	5,1	11000		<b>6004 2RSR</b>		0,07
	47	14	1	12,8	6,7	15000	18000	<b>6204</b>		0,118
	47	14	1	12,8	6,7	15000	18000	<b>6204 TN</b>		0,118
	47	14	1	12,8	6,7	15000		<b>6204 2ZR</b>		0,118
	47	14	1	12,8	6,7	10000		<b>6204 2RSR</b>		0,118
	47	14	1	12,8	6,7	15000	18000	<b>6204 NR</b>	SP47	0,118
	47	18	1	12,8	6,7	15000		<b>62204 2RSR</b>		0,131
	52	15	1,1	15,9	7,9	13000	16000	<b>6304</b>		0,158
	52	15	1,1	15,9	7,9	13000	16000	<b>6304 TN</b>		0,158
52	15	1,1	15,9	7,9	13000	16000	<b>6304 MAP5</b>		0,158	
52	15	1,1	15,9	7,9	13000		<b>6304 2ZR</b>		0,158	
52	15	1,1	15,9	7,9	8000		<b>6304 2RSR</b>		0,158	
52	15	1,1	15,9	7,9	13000	16000	<b>6304 NR</b>	SP52	0,158	
52	21	1,1	15,9	7,9	13000		<b>62304 2RSR</b>		0,197	
72	19	1,1	31	15,2	10000	13000	<b>6404</b>		0,42	
22	50	14	1	12,9	6,8	15000	18000	<b>62/22</b>		0,118
	50	14	1	12,9	6,8	15000		<b>62/22 2ZR</b>		0,118
	50	14	1	12,9	6,8	15000		<b>62/22 2RSR</b>		0,118
	56	16	1,1	18,5	9,5	13000	16000	<b>63/22</b>		0,201
	56	16	1,1	18,5	9,5	13000		<b>63/22 2ZR</b>		0,201
	56	16	1,1	18,5	9,5	13000		<b>63/22 2RSR</b>		0,201
25	37	7	0,3	4,35	2,6	18000	25000	<b>61805</b>		0,022
	42	9	0,3	6,65	4,1	16000	19000	<b>61905</b>		0,041
	47	8	0,3	8,4	5,1	15000	18000	<b>16005</b>		0,058
	47	12	0,6	10,1	5,9	15000	18000	<b>6005 TN</b>		0,086
	47	12	0,6	10,1	5,9	15000		<b>6005 2ZR</b>		0,086
47	12	0,6	10,1	5,9	9500		<b>6005 2RSR</b>		0,086	



### Single Row Deep Groove Ball Bearings

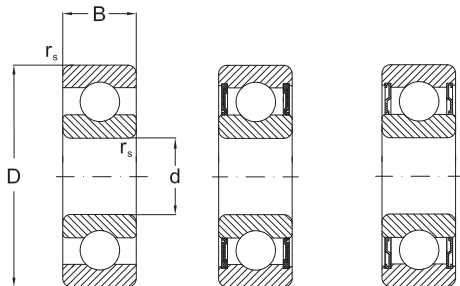

2RSR

2ZR

d	Dimensions			Basical radial load		Speed limit		Designation		Mass
	D	B	r <sub>s</sub> min	dyn. C <sub>r</sub>	stat. C <sub>0r</sub>	grease	oil	bearing	snap ring	
mm			kN		min <sup>-1</sup>		-		kg	
25	52	15	1	14	7,9	12000	15000	<b>6205</b>		0,142
	52	15	1	14	7,9	12000		<b>6205 2ZR</b>		0,142
	52	15	1	14	7,9	8000		<b>6205 2RSR</b>		0,142
	52	15	1	14	7,9	12000	15000	<b>6205 NR</b>	SP52	0,142
	52	18	1	14	7,9	12000		<b>62205 2RSR</b>		0,148
	62	17	1,1	20,6	11,3	11000	14000	<b>6305</b>		0,25
	62	17	1,1	20,6	11,3	11000	14000	<b>6305 MAP5</b>		0,25
	62	17	1,1	20,6	11,3	11000		<b>6305 2ZR</b>		0,25
	62	17	1,1	20,6	11,3	7500		<b>6305 2RSR</b>		0,25
	62	17	1,1	20,6	11,3	11000	14000	<b>6305 NR</b>	SP62	0,25
28	62	24	1,1	20,6	11,3	11000		<b>62305 2RSR</b>		0,317
	80	21	1,5	37,6	19	9000	11000	<b>6405</b>		0,575
	80	21	1,5	37,6	19	9000	11000	<b>6405 NR</b>	SP80	0,575
	58	16	1	10,7	6,65	14000	16000	<b>62/28</b>		0,173
	58	16	1	10,7	6,65	14000		<b>62/28 2ZR</b>		0,173
	58	16	1	10,7	6,65	14000		<b>62/28 2RSR</b>		0,173
30	68	18	1,1	19,5	11,5	10000	12000	<b>63/28</b>		0,328
	68	18	1,1	19,5	11,5	10000		<b>63/28 2ZR</b>		0,328
	68	18	1,1	19,5	11,5	10000		<b>63/28 RSR</b>		0,328
	42	7	0,3	4,4	2,9	15000	18000	<b>61806</b>		0,027
	42	7	0,3	4,4	2,9	15000	18000	<b>61806 NR</b>	SR42	0,027
	47	9	0,3	7,8	4,7	14000	17000	<b>61906</b>		0,045
	47	9	0,3	7,8	4,7	14000	17000	<b>61906 NR</b>	SR47	0,045
	55	9	3	11,2	7,35	12000	15000	<b>16006</b>		0,087
	55	13	1	13,2	8,25	12000	15000	<b>6006 TN</b>		0,129
	55	13	1	13,2	8,25	12000		<b>6006 2ZR</b>		0,129
	55	13	1	13,2	8,25	8000		<b>6006 2RSR</b>		0,129
	55	13	1	13,2	8,25	12000	15000	<b>6006 NR</b>	SP55	0,129
	62	16	1	19,5	11,3	10000	13000	<b>6206</b>		0,21
	62	16	1	19,5	11,3	10000		<b>6206 2ZR</b>		0,21
	62	16	1	19,5	11,3	7500		<b>6206 2RSR</b>		0,21
	62	16	1	19,5	11,3	10000	13000	<b>6206 NR</b>	SP62	0,21
62	20	1	19,5	11,3	10000		<b>62206 2RSR</b>		0,236	
72	19	1,1	29,5	15,8	9000	11000	<b>6306</b>		0,371	
72	19	1,1	29,5	15,8	9000	11000	<b>6306 MAP5</b>		0,371	

## Single Row Deep Groove Ball Bearings

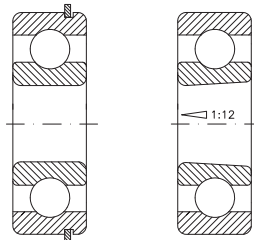

NR

K

d	Dimensions			Basic radial load		Speed limit		Designation		Mass
	D	B	$r_s$ min	dyn. $C_r$	stat. $C_{0r}$	grease	oil	bearing	snap ring	
mm				kN		min <sup>-1</sup>		-		kg
30	72	19	1,1	29,5	15,8	9000		<b>6306 2ZR</b>		0,371
	72	19	1,1	29,5	15,8	7000		<b>6306 2RSR</b>		0,371
	72	19	1,1	29,5	15,8	9000	11000	<b>6306 NR</b>	SP72	0,371
	72	27	1,1	26,6	14,9	9000		<b>62306 2RSR</b>		0,473
	90	23	1,5	47,3	24,5	8500	10000	<b>6406</b>		0,785
32	90	23	1,5	47,3	24,5	8500	10000	<b>6406 NR</b>	SP90	0,785
	65	17	1	23	13	10000	13000	<b>62/32</b>		0,228
	65	17	1	23	13	10000		<b>62/32 2ZR</b>		0,228
	65	17	1	23	13	10000		<b>62/32 2RSR</b>		0,228
	75	20	1,1	30	16	9000	11000	<b>63/32</b>		0,437
	75	20	1,1	30	16	9000		<b>63/32 2ZR</b>		0,437
35	75	20	1,1	30	16	9000		<b>63/32 2RSR</b>		0,437
	47	7	0,3	4	3,25	13000	16000	<b>61807</b>		0,031
	55	10	0,6	9,5	6,2	12000	14000	<b>61907</b>		0,073
	62	9	0,3	12,2	8,85	10000	13000	<b>16007</b>		0,111
	62	14	1	15,9	10,3	10000	13000	<b>6007</b>		0,164
	62	14	1	15,9	10,3	10000		<b>6007 2ZR</b>		0,164
	62	14	1	15,9	10,3	7000		<b>6007 2RSR</b>		0,164
	62	14	1	15,9	10,3	10000	13000	<b>6007 NR</b>	SP62	0,164
	72	17	1,1	25,7	15,6	9000	11000	<b>6207 K</b>		0,315
	72	17	1,1	25,7	15,6	9000	11000	<b>6207 TN</b>		0,315
	72	17	1,1	25,7	15,6	9000	11000	<b>6207 MAP6</b>		0,315
	72	17	1,1	25,7	15,6	9000	11000	<b>6207 P6</b>		0,315
	72	17	1,1	25,7	15,6	9000	11000	<b>6207 P5</b>		0,315
	72	17	1,1	25,7	15,6	9000		<b>6207 2ZR</b>		0,315
	72	17	1,1	25,7	15,6	6000		<b>6207 2RSR</b>		0,315
	72	17	1,1	25,7	15,6	9000	11000	<b>6207 NR</b>	SP72	0,315
	72	17	1,1	25,7	15,6	9000	11000	<b>6207 NRP6</b>	SP72	0,315
	72	17	1,1	25,7	15,6	9000	11000	<b>6207 MA</b>		0,315
	72	23	1,1	25,7	15,6	9000		<b>62207 2RSR</b>		0,375
	80	21	1,5	33,5	19,2	8500	10000	<b>6307</b>		0,45
80	21	1,5	33,5	19,2	8500	10000	<b>6307 K</b>		0,45	
80	21	1,5	33,5	19,2	8500	10000	<b>6307 P6</b>		0,45	
80	21	1,5	33,5	19,2	8500	10000	<b>6307 P5</b>		0,45	
80	21	1,5	33,5	19,2	8500		<b>6307 2ZR</b>		0,45	



### Single Row Deep Groove Ball Bearings

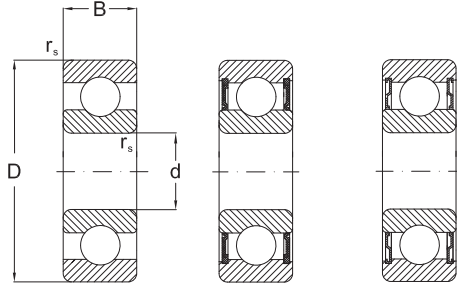

2RSR

2ZR

Dimensions				Basical radial load		Speed limit		Designation		Mass	
d	D	B	r <sub>s</sub> min	dyn. C <sub>r</sub>	stat. C <sub>0r</sub>	grease	oil	bearing	snap ring		
mm				kN		min <sup>-1</sup>		-		kg	
35	80	21	1,5	33,5	19,2	8500		<b>6307 2ZRP5</b>		0,45	
	80	21	1,5	33,5	19,2	6500		<b>6307 2RSR</b>		0,45	
	80	21	1,5	33,5	19,2	6500		<b>6307 2RSRP6</b>		0,45	
	80	21	1,5	33,5	19,2	6500		<b>6307 2RSRP5</b>		0,45	
	80	31	1,5	33,5	19,2	8500	10000	<b>6307 NR</b>		SP80	0,45
	80	31	1,5	33,5	19,2	8500		<b>62307 2RSR</b>			0,658
	100	25	1,5	55,5	29,4	7000	8500	<b>6407</b>			0,954
40	100	25	1,5	55,5	29,4	7000	8500	<b>6407 NR</b>		SP100	0,954
	52	7	0,3	4,5	4,05	11000	14000	<b>61808 P5</b>			0,034
	52	7	0,3	4,5	4,05	11000	14000	<b>61808 NR</b>		SR52	0,034
	62	12	0,6	14,5	10,2	11000	13000	<b>61908</b>			0,11
	62	12	0,6	14,5	10,2	11000	13000	<b>61908 NR</b>		SR62	0,11
	68	9	0,3	13,3	9,8	9500	12000	<b>16008</b>			0,13
	68	15	1	16,8	11,6	9500	12000	<b>6008</b>			0,21
	68	15	1	16,8	11,6	9500		<b>6008 2ZR</b>			0,21
	68	15	1	16,8	11,6	6000		<b>6008 2RSR</b>			0,21
	68	15	1	16,8	11,6	9500	12000	<b>6008 NR</b>		SP68	0,21
	80	18	1,1	32,6	20	8500	10000	<b>6208</b>			0,402
	80	18	1,1	32,6	20	8500	10000	<b>6208 K</b>			0,402
	80	18	1,1	32,6	20	8500	10000	<b>6208 P6</b>			0,402
	80	18	1,1	32,6	20	8500	10000	<b>6208 P5</b>			0,402
	80	18	1,1	32,6	20	8500		<b>6208 2ZR</b>			0,402
	80	18	1,1	32,6	20	5600		<b>6208 2RSR</b>			0,402
	80	18	1,1	32,6	20	5600		<b>6208 2RSRP5</b>			0,402
	80	18	1,1	32,6	20	8500	10000	<b>6208 NR</b>		SP80	0,402
	80	18	1,1	32,6	20	8500	10000	<b>6208 MB</b>			0,402
	80	18	1,1	32,6	20	8500	10000	<b>6208 NMA</b>			0,402
	80	23	1,1	32,6	20	8500		<b>62208 2RSR</b>			0,46
	90	23	1,5	40,8	24	7500	9000	<b>6308</b>			0,635
	90	23	1,5	40,8	24	7500	9000	<b>6308 K</b>			0,635
	90	23	1,5	40,8	24	7500	9000	<b>6308 TN</b>			0,635
	90	23	1,5	40,8	24	7500	9000	<b>6308 P6</b>			0,635
	90	23	1,5	40,8	24	7500	9000	<b>6308 P5</b>			0,635
	90	23	1,5	40,8	24	7500		<b>6308 2ZR</b>			0,635

## Single Row Deep Groove Ball Bearings

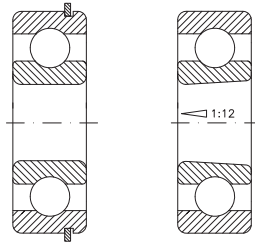

NR

K

Dimensions				Basical radial load		Speed limit		Designation		Mass
d	D	B	r <sub>s</sub> min	dyn. C <sub>r</sub>	stat. C <sub>0r</sub>	grease	oil	bearing	snap ring	
mm				kN		min <sup>-1</sup>		-		kg
40	90	23	1,5	40,8	24	7500		<b>6308 2ZRP5</b>		0,635
	90	23	1,5	40,8	24	5500		<b>6308 2RSR</b>		0,635
	90	23	1,5	40,8	24	7500	9000	<b>6308 NMA</b>		0,635
	90	23	1,5	40,8	24	7500	9000	<b>6308 NR</b>	SP90	0,635
	90	33	1,5	40,8	24	7500		<b>62308 2RSR</b>		0,874
	110	27	2	64	35	6700	7500	<b>6408</b>		1,23
	110	27	2	64	35	6700	7500	<b>6408 NR</b>	SP110	1,23
45	58	7	0,3	6,4	5,6	9500	12000	<b>61809</b>		0,043
	68	12	0,6	14	9,8	9700	12000	<b>61909</b>		0,12
	75	10	0,6	15,5	12,3	9000	11000	<b>16009</b>		0,17
	75	16	1	21	15	9000	11000	<b>6009</b>		0,261
	75	16	1	21	15	9000	11000	<b>6009 P5</b>		0,261
	75	16	1	21	15	9000	11000	<b>6009 P4</b>		0,261
	75	16	1	21	15	9000		<b>6009 2ZR</b>		0,261
	75	16	1	21	15	9000		<b>6009 2ZRP4</b>		0,261
	75	16	1	21	15	5600		<b>6209 2RSR</b>		0,261
	75	16	1	21	15	9000	11000	<b>6009 NR</b>	SP75	0,261
	85	19	1,1	32,7	20,6	7500	9000	<b>6209</b>		0,414
	85	19	1,1	32,7	20,6	7500	9000	<b>6209 K</b>		0,414
	85	19	1,1	32,7	20,6	7500	9000	<b>6209 P6</b>		0,414
	85	19	1,1	32,7	20,6	7500	9000	<b>6209 P5</b>		0,414
	85	19	1,1	32,7	20,6	7500		<b>6209 2ZR</b>		0,414
	85	19	1,1	32,7	20,6	5000		<b>6209 2ZRP5</b>		0,414
	85	19	1,1	32,7	20,6	5000		<b>6209 2RSR</b>		0,414
	85	19	1,1	32,7	20,6	5000		<b>6209 2RSRP6</b>		0,414
	85	19	1,1	32,7	20,6	5000		<b>6209 2RSRP5</b>		0,414
	85	19	1,1	32,7	20,6	7500	9000	<b>6209 NR</b>	SP85	0,414
	85	23	1,1	32,7	20,6	5600		<b>62209 2RSR</b>		0,481
	100	25	1,5	52,8	31,7	6700	8000	<b>6309</b>		0,838
	100	25	1,5	52,8	31,7	6700	8000	<b>6309 K</b>		0,838
	100	25	1,5	52,8	31,7	6700	8000	<b>6309 MB</b>		0,838
100	25	1,5	52,8	31,7	6700	8000	<b>6309 MAP6</b>		0,838	
100	25	1,5	52,8	31,7	6700	8000	<b>6309 P6</b>		0,838	
100	25	1,5	52,8	31,7	6700	8000	<b>6309 P5</b>		0,838	
100	25	1,5	52,8	31,7	6700		<b>6309 2ZR</b>		0,838	



### Single Row Deep Groove Ball Bearings

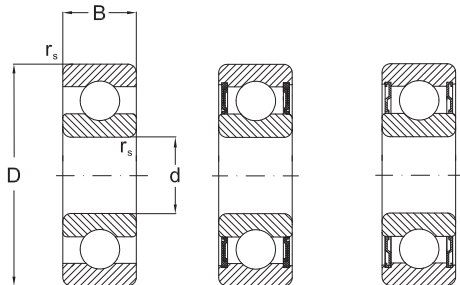

2RSR

2ZR

Dimensions				Basical radial load		Speed limit		Designation		Mass
d	D	B	r <sub>s</sub> min	dyn. C <sub>r</sub>	stat. C <sub>0r</sub>	grease	oil	bearing	snap ring	
mm				kN		min <sup>-1</sup>		-		kg
45	100	25	1,5	52,8	31,7	6700		<b>6309 2ZRP5</b>		0,838
	100	25	1,5	52,8	31,7	4500		<b>6309 2RSR</b>		0,838
	100	25	1,5	52,8	31,7	4500		<b>6309 2RSRP6</b>		0,838
	100	25	1,5	52,8	31,7	4500		<b>6309 2RSRP5</b>		0,838
	100	25	1,5	52,8	31,7	6700	8000	<b>6309 NR</b>	SP100	0,838
	100	36	1,5	52,8	31,7	4500		<b>62309 2RSR</b>		1,18
	120	29	2	76,8	44,9	5600	6700	<b>6409</b>		1,54
	120	29	2	76,8	44,9	5600	6700	<b>6409 NR</b>	SP120	1,54
50	65	7	0,3	6,8	6,3	9000	11000	<b>61810</b>		0,057
	65	7	0,3	6,8	6,3	9000	11000	<b>61810 NR</b>	SR65	0,057
	72	12	0,6	14,5	10,4	9000	11000	<b>61910</b>		0,13
	72	12	0,6	14,5	10,4	9000	11000	<b>61910 NR</b>	SR72	0,13
	80	10	0,6	16,3	13,1	8500	10000	<b>16010</b>		0,188
	80	16	1	21,8	16,6	8500	10000	<b>6010 K</b>		0,26
	80	16	1	21,8	16,6	8500		<b>6010 2ZR</b>		0,26
	80	16	1	21,8	16,6	5300		<b>6010 2RSR</b>		0,26
	80	16	1	21,8	16,6	8500	10000	<b>6010 NR</b>	SP80	0,26
	90	20	1,1	35,1	23,2	7000	8500	<b>6210</b>		0,46
	90	20	1,1	35,1	23,2	7000	8500	<b>6210 K</b>		0,46
	90	20	1,1	35,1	23,2	7000	8500	<b>6210 M</b>		0,46
	90	20	1,1	35,1	23,2	7000	8500	<b>6210 MAP6</b>		0,46
	90	20	1,1	35,1	23,2	7000	8500	<b>6210 P6</b>		0,46
	90	20	1,1	35,1	23,2	7000	8500	<b>6210 P5</b>		0,46
	90	20	1,1	35,1	23,2	7000		<b>6210 2ZR</b>		0,46
	90	20	1,1	35,1	23,2	7000		<b>6210 2ZRP5</b>		0,46
	90	20	1,1	35,1	23,2	4500		<b>6210 2RSR</b>		0,46
	90	20	1,1	35,1	23,2	4500		<b>6210 2RSRP6</b>		0,46
	90	20	1,1	35,1	23,2	4500		<b>6210 2RSRP5</b>		0,46
	90	20	1,1	35,1	23,2	7000	8500	<b>6210 NR</b>	SP90	0,46
90	23	1,1	35,1	23,2	7000		<b>62210 2RSR</b>		0,514	
110	27	2	61,8	37,9	6300	7000	<b>6310</b>		1,06	
110	27	2	61,8	37,9	6300	7000	<b>6310 K</b>		1,06	
110	27	2	61,8	37,9	6300	7000	<b>6310 MAP6</b>		1,06	
110	27	2	61,8	37,9	6300		<b>6310 2ZR</b>		1,06	
110	27	2	61,8	37,9	4000		<b>6310 2RSR</b>		1,06	



## Single Row Deep Groove Ball Bearings

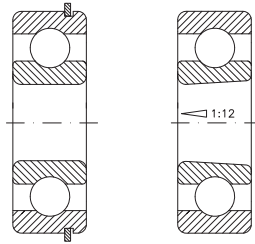

NR

K

Dimensions				Basical radial load		Speed limit		Designation		Mass
d	D	B	$r_s$ min	dyn. $C_r$	stat. $C_{0r}$	grease	oil	bearing	snap ring	
mm				kN		min <sup>-1</sup>		-		kg
50	110	27	2	61,8	37,9	6300	7000	<b>6310 NR</b>	SP110	1,06
	110	40	2	61,8	37,9	4000		<b>62310 2RSR</b>		1,65
	130	31	2,1	87,1	52	5000	6000	<b>6410</b>		1,89
	130	31	2,1	87,1	52	5000	6000	<b>6410 NR</b>	SP130	1,89
55	72	9	0,3	9	8,5	8500	10000	<b>61811</b>		0,083
	90	11	0,6	19,3	16,3	7500	9000	<b>16011</b>		0,26
	90	18	1,1	28,3	21,3	7500	9000	<b>6011 MB</b>		0,39
	90	18	1,1	28,3	21,3	7500		<b>6011 2ZR</b>		0,39
	90	18	1,1	28,3	21,3	4500		<b>6011 2RSR</b>		0,39
	90	18	1,1	28,3	21,3	7500	9000	<b>6011 NR</b>	SP90	0,39
	100	21	1,5	43,4	29,4	6300	7500	<b>6211</b>		0,611
	100	21	1,5	43,4	29,4	6300	7500	<b>6211 K</b>		0,611
	100	21	1,5	43,4	29,4	6300	7500	<b>6211 MA</b>		0,611
	100	21	1,5	43,4	29,4	6300		<b>6211 2ZR</b>		0,611
	100	21	1,5	43,4	29,4	4000		<b>6211 2RSR</b>		0,611
	100	21	1,5	43,4	29,4	6300	7500	<b>6211 NR</b>	SP100	0,611
	100	25	1,5	43,4	29,4	4000		<b>62211 2RSR</b>		0,7
	120	29	2	71,7	45	5300	6300	<b>6311</b>		1,38
	120	29	2	71,7	45	5300	6300	<b>6311 K</b>		1,38
	120	29	2	71,7	45	5300	6300	<b>6311 MA</b>		1,38
	120	29	2	71,7	45	5300		<b>6311 2ZR</b>		1,38
	120	29	2	71,7	45	3600		<b>6311 2RSR</b>		1,38
	120	29	2	71,7	45	5300	6300	<b>6311 NR</b>	SP120	1,38
	120	43	2	71,7	45	3600		<b>62311 2RSR</b>		2,04
140	33	2,1	100	62	4800	5600	<b>6411</b>		2,3	
140	33	2,1	100	62	4800	5600	<b>6411 NR</b>	SP140	2,3	
60	78	10	0,3	8,7	6,7	8000	9500	<b>61812</b>		0,12
	95	11	0,6	20	17,6	7000	8500	<b>16012</b>		0,28
	95	18	1,1	29,4	23,3	7000	8000	<b>6012</b>		0,42
	95	18	1,1	29,4	23,3	6700		<b>6012 2ZR</b>		0,42
	95	18	1,1	29,4	23,3	4300		<b>6012 2RSR</b>		0,42
	95	18	1,1	29,4	23,3	7000	8000	<b>6012 NR</b>	SP95	0,42
	110	22	1,5	52,4	36,3	6000	7000	<b>6212</b>		0,78
	110	22	1,5	52,4	36,3	6000	7000	<b>6212 K</b>		0,78
110	22	1,5	52,4	36,3	6000	7000	<b>6212 MA</b>		0,78	



### Single Row Deep Groove Ball Bearings

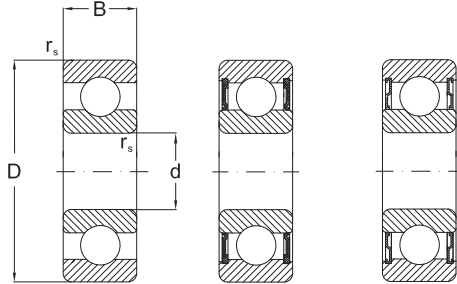

2RSR

2ZR

Dimensions				Basical radial load		Speed limit		Designation		Mass
d	D	B	r <sub>s</sub> min	dyn. C <sub>r</sub>	stat. C <sub>0r</sub>	grease	oil	bearing	snap ring	
mm				kN		min <sup>-1</sup>		-		kg
60	110	22	1,5	52,4	36,3	6000		<b>6212 2ZR</b>		0,78
	110	22	1,5	52,4	36,3	3800		<b>6212 2RSR</b>		0,78
	110	22	1,5	52,4	36,3	6000	7000	<b>6212 NR</b>	SP110	0,78
	110	28	1,5	52,4	36,3	6000	7000	<b>62212</b>		0,97
	130	31	2,1	81,9	52,2	5000	6000	<b>6312</b>		1,72
	130	31	2,1	81,9	52,2	5000	6000	<b>6312 K</b>		1,72
	130	31	2,1	81,9	52,2	5000		<b>6312 2ZR</b>		1,72
	130	31	2,1	81,9	52,2	3400		<b>6312 2RSR</b>		1,72
	130	31	2,1	81,9	52,2	5000	6000	<b>6312 NR</b>	SP130	1,72
	130	46	2,1	81,9	52,2	3400		<b>62312 2RSR</b>		2,55
62	150	35	2,1	110	70,8	4300	5000	<b>6412</b>		2,76
	150	35	2,1	110	70,8	4300	5000	<b>6412 NR</b>	SP150	2,76
62	110	22	1,5	47,5	28	6000	7000	<b>62/62</b>		0,6
	85	10	0,6	12,2	12	7000	8500	<b>61813</b>		0,13
65	100	11	0,6	22,9	19,6	6300	7500	<b>16013</b>		0,3
	100	18	1,1	30,5	25,4	6300	7500	<b>6013 K</b>		0,44
	100	18	1,1	30,5	25,4	6300		<b>6013 2ZR</b>		0,44
	100	18	1,1	30,5	25,4	4000		<b>6013 2RSR</b>		0,44
	100	18	1,1	30,5	25,4	6300	7500	<b>6013 NR</b>	SP100	0,44
	120	23	1,5	57,2	40	5300	6300	<b>6213</b>		0,995
	120	23	1,5	57,2	40	5300	6300	<b>6213 M</b>		0,995
	120	23	1,5	57,2	40	5300	6300	<b>6213 MA</b>		0,995
	120	23	1,5	57,2	40	5300	6300	<b>6213 2ZR</b>		0,995
	120	23	1,5	57,2	40	3600		<b>6213 2RSR</b>		0,995
	120	23	1,5	57,2	40	5300	6300	<b>6213 NR</b>	SP120	0,995
	140	33	2,1	92,7	59,7	4800	5600	<b>6313</b>		2,1
	140	33	2,1	92,7	59,7	4800	5600	<b>6313 MA</b>		2,1
	140	33	2,1	92,7	59,7	4800	5600	<b>6313 MB</b>		2,1
	140	33	2,1	92,7	59,7	4800		<b>6313 2ZR</b>		2,1
	140	33	2,1	92,7	59,7	3000		<b>6313 2RSR</b>		2,1
	140	33	2,1	92,7	59,7	4800	5600	<b>6313 NR</b>	SP140	2,1
	160	37	2,1	118	79	4000	4800	<b>6413</b>		3,3
160	37	2,1	118	79	4000	4800	<b>6413 NR</b>	SP160	3,3	
70	90	10	0,6	12,5	10	6700	8000	<b>61814</b>		0,16
	110	13	0,6	27,9	25	6000	7000	<b>16014</b>		0,433

## Single Row Deep Groove Ball Bearings

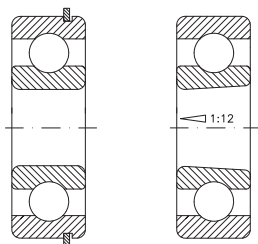

NR

K

d	Dimensions			Basical radial load		Speed limit		Designation		Mass
	D	B	$r_s$ min	dyn. $C_r$	stat. $C_{0r}$	grease	oil	bearing	snap ring	
mm			kN		min <sup>-1</sup>		-		kg	
70	110	20	1,1	38,1	30,9	6000	7000	<b>6014</b>		0,6
	110	20	1,1	38,1	30,9	6000	7000	<b>6014 MAP5</b>		0,6
	110	20	1,1	38,1	30,9	6000		<b>6014 2ZR</b>		0,6
	110	20	1,1	38,1	30,9	3800		<b>6014 2RSR</b>		0,6
	110	20	1,1	38,1	30,9	6000	7000	<b>6014 NR</b>	SP110	0,6
	125	24	1,5	62,2	44,1	5000	6000	<b>6214</b>		1,07
	125	24	1,5	62,2	44,1	5000	6000	<b>6214 MA</b>		1,07
	125	24	1,5	62,2	44,1	5000		<b>6214 2ZR</b>		1,07
	125	24	1,5	62,2	44	3400		<b>6214 2RSR</b>		1,07
	125	24	1,5	62,2	44	5000	6000	<b>6214 NR</b>	SP125	1,07
	125	31	1,5	62,2	44	3400		<b>62214 2RSR</b>		1,36
	150	35	2,1	104	68,1	4500	5300	<b>6314</b>		2,5
	150	35	2,1	104	68,1	4500	5300	<b>6314 K</b>		2,5
	150	35	2,1	104	68,1	4500	5300	<b>6314 MAP6</b>		2,5
	150	35	2,1	104	68,1	4500		<b>6314 2ZR</b>		2,5
	150	35	2,1	104	68,1	2900		<b>6314 2RSR</b>		2,5
	150	35	2,1	104	68,1	4500	5300	<b>6314 NR</b>	SP150	2,5
	150	51	2,1	104	68,1	2900		<b>62314 2RSR</b>		3,55
75	180	42	3	144	104	3800	4500	<b>6414</b>		4,85
	95	10	0,6	12,8	12,1	6300	7500	<b>61815 P5</b>		0,16
	95	10	0,6	12,8	12,1	4000		<b>61815 2RSR</b>		0,16
	115	13	0,6	28,5	26,8	5600	6700	<b>16015</b>		0,46
	115	20	1,1	39,7	33,5	5600	6700	<b>6015 M</b>		0,64
	115	20	1,1	39,7	33,5	5600	6700	<b>6015 MAP5</b>		0,64
	115	20	1,1	39,7	33,5	5600		<b>6015 2ZR</b>		0,64
	115	20	1,1	39,7	33,5	3600		<b>6015 2RSR</b>		0,64
	115	20	1,1	39,7	33,5	5600	6700	<b>6015 NR</b>	SP115	0,64
	130	25	1,5	67,4	49,3	4800	5600	<b>6215</b>		1,18
	130	25	1,5	67,4	49,3	4800	5600	<b>6215 K</b>		1,18
	130	25	1,5	67,4	49,3	4800		<b>6215 2ZR</b>		1,18
	130	25	1,5	67,4	49,3	3200		<b>6215 2RSR</b>		1,18
	130	25	1,5	67,4	49,3	4800	5600	<b>6215 NR</b>	SP130	1,18
	160	37	2,1	113	77	4000	4800	<b>6315</b>		3,03
	160	37	2,1	113	77	4000	4800	<b>6315 MP6</b>		3,03
	160	37	2,1	113	77	4000		<b>6315 2ZR</b>		3,03



### Single Row Deep Groove Ball Bearings

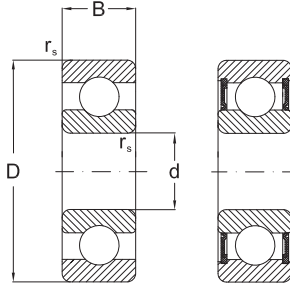

2RSR

Dimensions				Basical radial load		Speed limit		Designation		Mass
d	D	B	r <sub>s</sub> min	dyn. C <sub>r</sub>	stat. C <sub>0r</sub>	grease	oil	bearing	snap ring	
mm				kN		min <sup>-1</sup>		-		kg
75	160	37	2,1	113	77	2800		<b>6315 2RSR</b>		3,03
	160	37	2,1	113	77	4000	4800	<b>6315 NR</b>	SP160	3,03
	190	45	3	154	115	3600	4300	<b>6415</b>		6,5
80	100	10	0,6	12,9	13,7	6000	7000	<b>61816</b>		0,16
	110	16	1	25,1	20,5	5600	6700	<b>61916</b>		0,38
	125	14	0,6	31,9	29,7	5300	6300	<b>16016</b>		0,6
	125	22	1,1	47,6	39,8	5300	6300	<b>6016 MA</b>		0,85
	125	22	1,1	47,6	39,8	5300		<b>6016 2ZR</b>		0,85
	125	22	1,1	47,6	39,8	3400		<b>6016 2RSR</b>		0,85
	125	22	1,1	47,6	39,8	5300	6300	<b>6016 NR</b>	SP125	0,85
	140	26	2	72,7	53	4500	5300	<b>6216</b>		1,4
	140	26	2	72,7	53	4500	5300	<b>6216 K</b>		1,4
	140	26	2	72,7	53	4500	5300	<b>6216 MA</b>		1,4
	140	26	2	72,7	53	3000		<b>6216 2ZR</b>		1,4
	140	26	2	72,7	53	4500	5300	<b>6216 NR</b>	SP140	1,4
	140	33	2	72,7	53	3000		<b>62216 2RSR</b>		1,7
	170	39	2,1	123	86,5	3800	4500	<b>6316 K</b>		3,6
	170	39	2,1	123	86,5	3800	4500	<b>6316 M</b>		3,6
	170	39	2,1	123	86,5	3800		<b>6316 2ZR</b>		3,6
	170	58	2,1	123	86,5	2500		<b>62316 2RSR</b>		4,2
170	39	2,1	123	86,5	3800	4500	<b>6316 NR</b>	SP170	3,6	
200	48	3	164	125	3400	4000	<b>6416</b>		7,5	
85	110	13	1	19,3	20	5300	6300	<b>61817</b>		0,29
	130	14	1	33,8	33,5	5000	6000	<b>16017</b>		0,63
	130	22	1,1	49,5	43,1	5000	6000	<b>6017</b>		0,89
	130	22	1,1	49,5	43,1	5000		<b>6017 2ZR</b>		0,89
	130	22	1,1	49,5	43,1	3200		<b>6017 2RSR</b>		0,89
	130	22	1,1	49,5	43,1	5000	6000	<b>6017 NR</b>	SP130	0,89
	150	28	2	84	61,9	4300	5000	<b>6217</b>		1,8
	150	28	2	84	61,9	4300	5000	<b>6217 K</b>		1,8
	150	28	2	84	61,9	4300	5000	<b>6217 MP6</b>		1,8
	150	28	2	84	61,9	4300		<b>6217 2ZR</b>		1,8
	150	28	2	84	61,9	2800		<b>6217 2RSR</b>		1,8
150	28	2	84	61,9	4300	5000	<b>6217 NR</b>	SP150	1,8	

## Single Row Deep Groove Ball Bearings

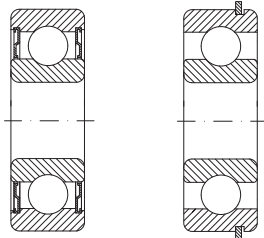

2ZR

NR

Dimensions				Basical radial load		Speed limit		Designation		Mass
d	D	B	r <sub>s</sub> min	dyn. C <sub>r</sub>	stat. C <sub>0r</sub>	grease	oil	bearing	snap ring	
mm				kN		min <sup>-1</sup>		-		kg
85	150	36	2	84	61,9	2800		<b>62217 2RSR</b>		2,1
	180	41	3	133	96,9	3600	4300	<b>6317</b>		4,2
	180	41	3	133	96,9	3600	4300	<b>6317 K</b>		4,2
	180	41	3	133	96,9	3600	4300	<b>6317 MA</b>		4,2
	180	41	3	133	96,9	3600	4300	<b>6317 MB</b>		4,2
	180	41	3	133	96,9	3600	4300	<b>6317 ZZR</b>		4,2
	180	41	3	133	96,9	3600	4300	<b>6317 NR</b>	SP180	4,2
	180	60	3	133	96,9	2300		<b>62317 2RSR</b>		4,8
	210	52	4	173	136	3200	3800	<b>6417</b>		9
90	115	13	1	19,6	20,4	5300	6300	<b>61818</b>		0,3
	140	16	1	41,9	40,4	4500	5300	<b>16018</b>		0,85
	140	24	1,5	58,2	49,7	4500	5300	<b>6018 MA</b>		1,16
	140	24	1,5	58,2	49,7	4500	5300	<b>6018 MP6</b>		1,16
	140	24	1,5	58,2	49,7	4500		<b>6018 2ZR</b>		1,16
	140	24	1,5	58,2	49,7	3000		<b>6018 2RSR</b>		1,16
	140	24	1,5	58,2	49,7	4500	5300	<b>6018 NR</b>	SP140	1,6
	160	30	2	96	71,5	3800	4500	<b>6218</b>		2,16
	160	30	2	96	71,5	3800	4500	<b>6218 K</b>		2,16
	160	30	2	96	71,5	3800	4500	<b>6218 MA</b>		2,16
	160	30	2	96	71,5	3800	4500	<b>6218 MP6</b>		2,16
	160	30	2	96	71,5	2600		<b>6218 2RSR</b>		2,16
	160	30	2	96	71,5	3800		<b>6218 2ZR</b>		2,16
	160	30	2	96	71,5	3800	4500	<b>6218 NR</b>	SP160	2,16
	160	40	2	96	71,5	2600		<b>62218 2RSR</b>		2,4
	190	43	3	143	107	3400	4000	<b>6318</b>		4,9
	190	43	3	143	107	3400	4000	<b>6318 K</b>		4,9
	190	43	3	143	107	3400	4000	<b>6318 M</b>		4,9
	190	43	3	143	107	3400		<b>6318 2ZR</b>		4,9
	190	43	3	143	107	3400	4000	<b>6318 NR</b>	SP190	4,9
190	64	3	143	107	2100		<b>62318 2RSR</b>		5,5	
225	54	4	190	160	3000	3600	<b>6418</b>		11,5	
145	16	1	42,3	41,5	4300	5000	<b>16019</b>		0,89	
145	24	1,5	60,5	53,6	4300	5000	<b>6019</b>		1,2	
95	145	24	1,5	60,5	53,6	4300		<b>6019 2ZR</b>		1,2
	145	24	1,5	60,5	53,6	2900		<b>6019 2RSR</b>		1,2



### Single Row Deep Groove Ball Bearings

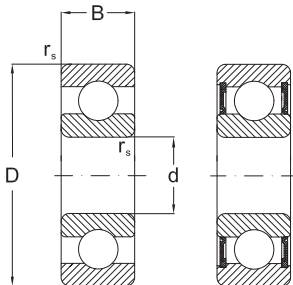

2RSR

Dimensions				Basical radial load		Speed limit		Designation		Mass
d	D	B	r <sub>s</sub> min	dyn. C <sub>r</sub>	stat. C <sub>0r</sub>	grease	oil	bearing	snap ring	
mm				kN		min <sup>-1</sup>		-		kg
95	145	24	1,5	60,5	53,6	4300	5000	6019 NR	SP145	1,2
	170	32	2,1	109	81,9	3600	4300	6219 MBP6		2,6
	170	32	2,1	109	81,9	2400		6219 2RSR		2,6
	170	32	2,1	109	81,9	3600		6219 2ZR		2,6
	170	32	2,1	109	81,9	3600	4300	6219 NR	SP170	2,6
	170	43	2,1	109	81,9	2400		62219 2RSR		2,8
	200	45	3	153	118	3200	3800	6319		5,6
	200	45	3	153	118	3200	3800	6319 MAP6		5,6
	200	67	3	153	118	2000		62319 2RSR		6,5
100	125	13	1	19,6	21,2	4800	5600	61820 MAP5		0,32
	150	16	1	45	44	4300	5000	16020		0,91
	150	24	1,5	60,5	54	4300	5000	6020 MAP6		1,25
	150	24	1,5	60,5	54	4300		6020 2ZR		1,25
	150	24	1,5	60,5	54	2800		6020 2RSR		1,25
	150	24	1,5	60,5	54	4300	5000	6020 NR	SP150	1,25
	180	34	2,1	124	93	3400	4000	6220		3,1
	180	34	2,1	124	93	2200		6220 2RSR		3,1
	180	34	2,1	124	93	3400		6220 2ZR		3,1
	180	34	2,1	124	93	3400	4000	6220 MA		3,15
	180	34	2,1	124	93	3400	4000	6220 MP6		3,15
	180	34	2,1	124	93	3400	4000	6220 NR	SP180	3,15
	180	46	2,1	124	93	2200		62220 2RSR		3,58
	215	47	3	173	140	3000		6320 2ZR		7
215	47	3	173	140	3000	3600	6320 MAP6		7	
105	130	13	1	20,8	19	4500	5300	61821 MAP5		0,35
	160	18	1	52	51	4000	4800	16021		1,2
	160	26	2	72,3	65,8	3800	4500	6021 M		1,6
	160	26	2	72,3	65,8	2400		6021 2RSR		1,6
	160	26	2	72,3	65,8	3800		6021 2ZR		1,6
	160	26	2	72,3	65,8	3800	4500	6021 NR	SP160	1,6
	190	36	2,1	133	104	3200	3800	6221		3,7
	190	36	2,1	133	104	2100		6221 2RSR		3,7
	190	36	2,1	133	104	3200		6221 2ZR		3,7
	190	36	2,1	133	104	3200	3800	6221 MA		3,7
	225	49	3	184	153	2800	3400	6321 MA		8

## Single Row Deep Groove Ball Bearings

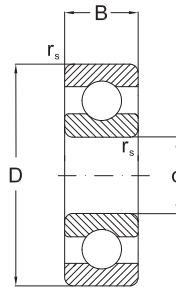

Dimensions				Basical radial load		Speed limit		Designation		Mass
d	D	B	r <sub>s</sub> min	dyn. C <sub>r</sub>	stat. C <sub>0r</sub>	grease	oil	bearing	snap ring	
mm				kN		min <sup>-1</sup>		-		kg
110	140	16	1	28,1	29	4300	5000	<b>61822</b>		0,6
	170	19	1	57,5	56,7	3800	4500	<b>16022</b>		1,46
	170	28	2	82	73	3600	4300	<b>6022</b>		1,95
	170	28	2	82	73	2300		<b>6022 2RSR</b>		1,95
	170	28	2	82	73	3600		<b>6022 2ZR</b>		1,95
	170	28	2	82	73	3600	4300	<b>6022 NR</b>	SP170	1,95
	200	38	2,1	143	118	3000	3600	<b>6222</b>		4,35
	200	38	2,1	143	118	1900		<b>6222 2RSR</b>		4,35
	200	38	2,1	143	118	3000		<b>6222 2ZR</b>		4,35
	200	38	2,1	143	118	3000	3600	<b>6222 M</b>		4,35
120	200	38	2,1	143	118	3000	3600	<b>6222 NR</b>	SP200	4,35
	240	50	3	203	178	2600	3200	<b>6322</b>		9,58
	240	50	3	203	178	2600	3200	<b>6322 MA</b>		9,58
	150	16	1	29,1	32,5	3800	4500	<b>61824</b>		0,65
	180	19	1	63,2	63,3	3400	4000	<b>16024</b>		1,7
	180	28	2	85	79,3	3400	4000	<b>6024 MP6</b>		2,09
	180	28	2	85	79,3	2100		<b>6024 2RSR</b>		2,09
	180	28	2	85	79,3	3400		<b>6024 2ZR</b>		2,09
	180	28	2	85	79,3	3400	4000	<b>6024 NR</b>	SP180	2,09
	215	40	2,1	155	131	2800	3400	<b>6224</b>		5,15
130	215	40	2,1	155	131	2800	3400	<b>6224 MB</b>		5,15
	215	40	2,1	155	131	2800	3400	<b>6224 MAP6</b>		5,15
	215	40	2,1	155	131	2800		<b>6224 2ZR</b>		5,15
	215	40	2,1	155	131	2800	3400	<b>6224 NR</b>	SP215	5,15
	260	55	3	212	190	2400	3000	<b>6324 MA</b>		13,6
	165	18	1,1	38	43	3600	4300	<b>61826 MAP5</b>		0,93
	200	22	1,1	79	81	3200	3800	<b>16026</b>		2,5
	200	33	2	106	101	3000	3600	<b>6026</b>		3,25
	200	33	2	106	101	1900		<b>6026 2RSR</b>		3,25
	200	33	2	106	101	3000		<b>6026 2ZR</b>		3,25
200	33	2	106	101	3000	3600	<b>6026 NR</b>	SP200	3,25	
230	40	3	167	146	2600	3200	<b>6226</b>		6	
230	40	3	167	146	2600	3200	<b>6226 M</b>		6	
280	58	4	229	214	2200	2800	<b>6326 MA</b>		17	
140	175	18	1,1	39	46	3400	4000	<b>61828 MAP5</b>		1



### Single Row Deep Groove Ball Bearings

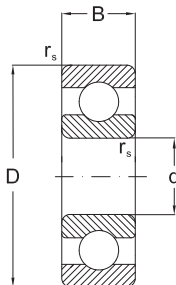

Dimensions				Basical radial load		Speed limit		Designation		Mass
d	D	B	r <sub>s</sub> min	dyn. C <sub>r</sub>	stat. C <sub>0r</sub>	grease	oil	bearing	snap ring	
mm				kN		min <sup>-1</sup>		-		kg
140	210	22	1,1	80,5	86	2800	3400	16028		2,7
	210	33	2	110	109	2800	3400	6028 MP6		3,35
	250	42	3	176	164	2400	3000	6228		7,5
	250	42	3	176	164	2400	3000	6228 MA		7,5
	300	62	4	253	246	2000	2600	6328 MA		21
150	190	20	1,1	48,8	61	3000	3600	61830		1,4
	225	24	1,1	92,3	98	2600	3200	16030		3,4
	225	35	2,1	125	126	2600	3200	6030 MA		4,75
	270	45	3	176	170	2000	2600	6230 MA		9,6
	320	65	4	275	284	1900	2400	6330 MA		25
160	200	20	1,1	52	62	2800	3400	61832		1,49
	240	25	1,5	99,4	107	2400	3000	16032		3,6
	240	38	2,1	140	143	2400	3000	6032 MA		5,85
	290	48	3	185	186	1900	2400	6232 MA		15
170	215	22	1,1	61,8	73,5	2600	3200	61834 P6		2
	260	28	1,5	118	127	2200	2800	16034		5,7
	260	42	2,1	168	172	2200	2800	6034 MA		7,8
	310	52	4	212	224	1900	2400	6234 MA		17,5
180	225	22	1,1	62,3	78,5	2400	3000	61836 P5		2
	250	33	2	128	137	2200	2800	61936 MA		4,9
	280	31	2	140	146	2000	2600	16036 MA		7
	280	46	2,1	186	194	2000	2600	6036		10,5
	320	52	4	227	242	1800	2200	6236		18,5
190	240	24	1,5	74,1	92	2200	2800	61838		2,6
	290	31	2	148	162	2000	2600	16038		7,9
	290	46	2,1	194	210	2000	2600	6038 MA		11
	290	46	2,1	194	210	2000	2600	6038 MB		11
	290	46	2,1	194	210	2000	2600	6038 MBP6		11
	290	46	2,1	194	210	2000	2600	6038 MBP5		11
	340	55	4	255	278	1700	2000	6238 MA		23
	340	55	4	255	278	1700	2000	6238 MB		23
200	250	24	1,5	78	93	2200	2800	61840 MB		2,7
	280	38	2,1	151	160	2200	2800	61940 MB		7,25
	310	34	2	168	187	1900	2400	16040 MBP6		9
	310	34	2	168	187	1900	2400	16040 MBP5		9



## Single Row Deep Groove Ball Bearings

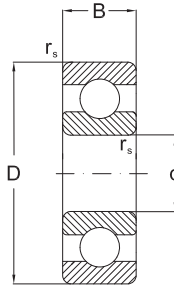

Dimensions				Basical radial load		Speed limit		Designation		Mass
d	D	B	r <sub>s</sub> min	dyn. C <sub>r</sub>	stat. C <sub>0r</sub>	grease	oil	bearing	snap ring	
mm				kN		min <sup>-1</sup>		-		kg
200	310	51	2,1	208	226	1900	2400	<b>6040 MA</b>		13,5
	310	51	2,1	208	226	1900	2400	<b>6040 MB</b>		13,5
	310	51	2,1	208	226	1900	2400	<b>6040 MBP52</b>		13,5
	360	58	4	280	314	1700	2000	<b>6240 M</b>		28
	360	58	4	280	314	1700	2000	<b>6240 MB</b>		27
220	270	24	1,5	78	110	1900	2400	<b>61844 M</b>		3
	300	38	2,1	151	180	1900	2400	<b>61944 M</b>		8
	340	37	2,1	174	204	1800	2200	<b>16044 M</b>		12
	340	56	3	245	290	1700	2000	<b>6044 M</b>		18
	400	65	4	290	354	1500	1800	<b>6244 M</b>		36,9
	460	88	5	410	520	1300	1600	<b>6344 M</b>		74,5
240	300	28	2	108	150	1800	2200	<b>61848 M</b>		4,5
	320	38	2,1	159	200	1800	2200	<b>61948 M</b>		8,6
	360	37	2,1	185	228	1600	1900	<b>16048</b>		14,3
	360	56	3	255	315	1600	1900	<b>6048 M</b>		19,9
	440	72	4	358	475	1400	1700	<b>6248 M</b>		50,2
	500	95	5	442	585	1100	1400	<b>6348 M</b>		96
260	320	28	2	96	125	1700	2000	<b>61852 M</b>		4,8
	360	46	2,1	212	270	1600	1900	<b>61952 M</b>		14,5
	400	44	3	238	310	1500	1800	<b>16052 M</b>		21,2
	400	65	4	300	390	1400	1700	<b>6052 MA</b>		31,1
	480	80	5	390	530	1100	1400	<b>6252 M</b>		66,6
	540	102	6	507	710	1000	1300	<b>6352 M</b>		119
280	350	33	2	125	170	1600	1900	<b>61856 MA</b>		7,4
	380	46	2,1	216	285	1500	1800	<b>61956 M</b>		15,5
	420	44	3	240	325	1400	1700	<b>16056</b>		23,1
	420	65	4	305	425	1400	1700	<b>6056 M</b>		33
	500	80	5	423	600	1100	1400	<b>6256 M</b>		70,5
	580	108	6	572	850	950	1200	<b>6356 M</b>		146
300	380	38	2,1	150	195	1400	1700	<b>61860 M</b>		10,5
	420	56	3	270	375	1300	1600	<b>61960 M</b>		24,5
	460	50	4	295	415	1300	1600	<b>16060 M</b>		32,7
	460	74	4	360	510	1200	1500	<b>6060 M</b>		43,2
320	400	38	2,1	172	255	1300	1600	<b>61864 M</b>		11
	440	56	3	276	400	1200	1500	<b>61964 M</b>		25,5



### Single Row Deep Groove Ball Bearings

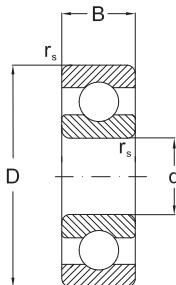

Dimensions				Basical radial load		Speed limit		Designation		Mass
d	D	B	r <sub>s</sub> min	dyn. C <sub>r</sub>	stat. C <sub>0r</sub>	grease	oil	bearing	snap ring	
mm				kN		min <sup>-1</sup>		-		kg
340	480	50	4	305	446	1200	1500	<b>16064 M</b>		34,4
	480	74	4	375	550	1200	1500	<b>6064 M</b>		49,4
	420	38	2,1	178	275	1200	1500	<b>61868 M</b>		11,5
	460	56	3	281	425	1100	1400	<b>61968 M</b>		26,5
	520	57	4	347	528	1100	1400	<b>16068 MA</b>		47,3
360	520	74	5	440	658	1100	1400	<b>6068 M</b>		61,4
	440	38	2,1	182	285	1100	1400	<b>61872 MA</b>		12
	480	56	3	291	450	1100	1400	<b>61972 M</b>		28
	540	57	4	351	550	1000	1300	<b>16072 M</b>		49,5
380	540	82	5	455	735	1000	1300	<b>6072 M</b>		64,4
	480	38	2,1	242	390	1000	1300	<b>61876 M</b>		20
	520	56	4	338	540	1000	1300	<b>61976 M</b>		40
	560	57	4	377	620	950	1200	<b>16076 M</b>		50,5
400	560	82	5	450	723	1000	1300	<b>6076 M</b>		67,6
	500	46	2,1	220	335	1000	1300	<b>61880 M</b>		20,5
	540	65	4	345	570	950	1200	<b>61980 M</b>		41,5
420	600	90	5	523	857	900	1100	<b>6080 M</b>		87,2
	520	46	2,1	224	345	950	1200	<b>61884 M</b>		21,5
	560	65	4	351	600	900	1100	<b>61984 M</b>		43
440	620	90	5	507	880	900	1100	<b>6084 M</b>		93
	540	46	2,1	228	355	900	1100	<b>61888 M</b>		22,5
	600	74	4	410	720	900	1100	<b>61988 M</b>		60,5
460	650	94	6	553	965	850	1000	<b>6088 M</b>		105
	580	56	3	319	570	900	1100	<b>61892 M</b>		35
	620	74	4	423	750	850	1000	<b>61992 M</b>		62,5
	680	100	6	580	1056	800	950	<b>6092 M</b>		121
480	600	56	3	325	600	850	950	<b>61896 M</b>		36,5
	650	78	5	449	815	800	950	<b>61996 M</b>		74
	700	100	6	615	1130	750	900	<b>6096 M</b>		126
500	620	56	3	332	620	850	950	<b>618/500 M</b>		37,5
	670	78	5	462	865	750	900	<b>619/500 M</b>		77
	720	100	6	607	1138	740	890	<b>60/500 M</b>		135
530	650	56	3	332	655	850	950	<b>618/530 M</b>		39,5
	710	82	5	488	930	700	850	<b>619/530 M</b>		90,5
	780	112	6	670	1290	670	800	<b>60/530 M</b>		186

## Single Row Deep Groove Ball Bearings

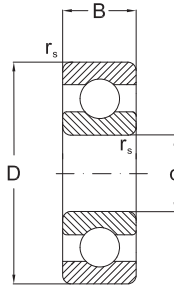

Dimensions				Basical radial load		Speed limit		Designation		Mass
d	D	B	$r_s$ min	dyn. $C_r$	stat. $C_{0r}$	grease	oil	bearing	snap ring	
mm				kN		min <sup>-1</sup>		-		kg
<b>560</b>	680	56	3	345	695	700	850	<b>618/560 M</b>		42
	750	85	5	494	980	670	800	<b>619/560 M</b>		105
	820	115	6	720	1400	630	750	<b>60/560 M</b>		208
<b>600</b>	730	60	3	364	765	670	800	<b>618/600 M</b>		52
	800	90	5	585	1220	630	750	<b>619/600 M</b>		125
	870	118	6	826	1753	630	750	<b>60/600 M</b>		236
<b>630</b>	920	128	7,5	819	1760	560	670	<b>60/630 M</b>		285
<b>670</b>	820	69	4	442	1000	560	670	<b>618/670 M</b>		77,5
	900	103	6	676	1500	530	630	<b>619/670 M</b>		185
	980	136	7,5	904	2040	500	600	<b>60/670 M</b>		345
<b>750</b>	920	78	5	527	1250	500	600	<b>618/750 M</b>		110
	1000	112	6	663	1500	500	600	<b>619/750 M</b>		255



# Double Row Deep Groove Ball Bearings

## Standards, Boundary dimensions

Standard plans	DIN 616
Deep groove ball bearing	DIN 625

## General

Double Row Deep groove ball bearings feature higher load ratings when compared to single row bearings.

This two row bearing gives a very rigid arrangement, but they are very sensitive to misalignments.

## Tolerances

**URB** Double Row Deep groove bearings are produced in normal tolerance class (**PN**) as standard.

## Internal clearance

**URB** Double Row Deep groove ball bearings are produced with **normal internal clearance, (CN)** as standard. Other internal clearance groups may be produced upon request.

## Design variants, Cages

**URB Double Row Deep groove ball bearings** have the latest design (suffix B) without filling slots.

Thus they are able to support thrust loads equally well in both directions. These bearings are fitted with **polyamide cages**, (suffix **TN**) as standard.

These bearing sizes are also available with **pressed steel cages**.

But, it must be considered that some of these bearings may have filling slots which limit the ability to support thrust loads in the direction of these filling slots.



### Double Row Deep Groove Ball Bearings

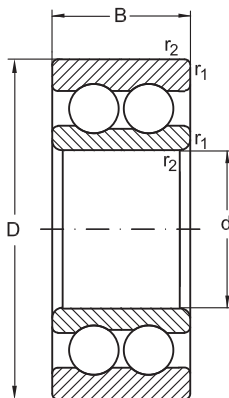

Dimensions				Basical load ratings		Speed rating		Designation	Mass
d	D	B	$r_1, r_2$ min.	dyn. $C_r$	stat. $C_{0r}$	grease	oil		kg
mm				kN		min <sup>-1</sup>			
10	30	14	0,6	9,2	5,2	18000	22000	<b>4200 BTN</b>	0,049
12	32	14	0,6	10,6	6,2	17000	20000	<b>4201 BTN</b>	0,053
15	35	14	0,6	11,9	7,5	14000	17000	<b>4202 BTN</b>	0,059
	42	17	1	14,8	9,5	12000	15000	<b>4302 BTN</b>	0,12
17	40	16	0,6	14,8	9,5	12000	15000	<b>4203 BTN</b>	0,09
	47	19	1	19,5	13,5	10000	13000	<b>4303 BTN</b>	0,16
20	47	18	1	17,8	12,5	10000	13000	<b>4204 BTN</b>	0,14
	52	21	1,1	23,4	16	9500	12000	<b>4304 BTN</b>	0,21
25	52	18	1	19	14,5	9000	11000	<b>4205 BTN</b>	0,16
	62	24	1,1	31,9	22,5	8500	10000	<b>4305 BTN</b>	0,34
30	62	20	1	26	20,5	8000	9500	<b>4206 BTN</b>	0,26
	72	27	1,1	41,2	30	7000	8500	<b>4306 BTN</b>	0,5
35	72	23	1,1	35,1	28,5	6700	8000	<b>4207 BTN</b>	0,4
	80	31	1,5	50,5	38	6300	7500	<b>4307 BTN</b>	0,69
40	80	23	1,1	37,05	32,5	6000	7000	<b>4208 BTN</b>	0,5

## Double Row Deep Groove Ball Bearings

Abutment and fillet dimensions  
see on page 89

Dimensions				Basical load ratings		Speed rating		Designation	Mass
d	D	B	$r_1, r_2$ min.	dyn. $C_r$	stat. $C_{0r}$	grease	oil		
mm				kN		min <sup>-1</sup>			
<b>40</b>	90	33	1,5	55,7	45	5600	6700	<b>4308 BTN</b>	0,95
<b>45</b>	85	23	1,1	39	36	5600	6700	<b>4209 BTN</b>	0,54
	100	36	1,5	68,5	56	5000	6000	<b>4309 BTN</b>	1,25
<b>50</b>	90	23	1,1	40,5	40	5000	6000	<b>4210 BTN</b>	0,58
	110	40	2	81,5	70	4500	5300	<b>4310 BTN</b>	1,7
<b>55</b>	100	25	1,5	45	44	4800	5600	<b>4211 BTN</b>	0,8
	120	43	2	97,5	83	4300	5000	<b>4311 BTN</b>	2,15
<b>60</b>	110	28	1,5	57	55	4500	5300	<b>4212 BTN</b>	1,1
	130	46	2,1	112	98	3800	4500	<b>4312 BTN</b>	2,65
<b>65</b>	120	31	1,5	67,5	67	4000	4800	<b>4213 BTN</b>	1,45
<b>70</b>	125	31	1,5	70	73,5	3600	4300	<b>4214 BTN</b>	1,5
<b>75</b>	130	31	1,5	72,5	80	3400	4000	<b>4215 BTN</b>	1,6
<b>80</b>	140	33	2	80,5	90	3200	3800	<b>4216 BTN</b>	2
<b>85</b>	150	36	2	93,6	102	3000	3600	<b>4217 BTN</b>	2,55
<b>90</b>	160	40	2	112	122	2800	3400	<b>4218 BTN</b>	3,2





# Self-aligning ball bearings

Self-aligning ball bearings have a common sphered raceway in the outer ring. This feature allows angular misalignment of the shaft relative to the housing. Therefore self-aligning ball bearings are particularly used in case of bearings where misalignment can occur from errors in mounting or from shaft bending.

Double row self-aligning ball bearings are manufactured both with cylindrical bore and tapered bore (taper 1:12). Self-aligning bearings with tapered bore can be delivered, at request, with adapter sleeves.



12  
13  
22  
23



12 K  
13 K  
22 K  
23 K

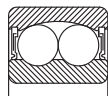

22 2RSR  
23 2RSR

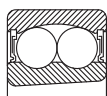

22 K2RSR  
23 K2RSR

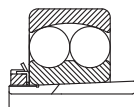

K+H

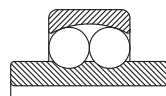

112  
113

## Suffixes

- C2** - radial clearance smaller than normal
- C3** - radial clearance larger than normal
- H** - adapter sleeve
- K** - tapered bore bearings
- M** - machined brass cage, ball guided
- MB** - machined brass cage, guided on the inner ring
- P6** - tolerance class more accurate than normal
- P63** - tolerance class P6 with radial clearance C3
- 2RSR** - bearing with two seals
- TN** - polyamide cage

## Sealed self-aligning ball bearings

Self-aligning ball bearings are also available in a sealed version with seals at both sides. The seals are made of gasoline, oil and wear-resistant synthetic rubber. Sealed bearings are delivered filled with a certain grease quantity. Sealed bearing operating temperatures are between  $-30^{\circ}\text{C}$  and  $+80^{\circ}\text{C}$ . Grease service life is much reduced if bearing

operates at a temperature higher than  $+80^{\circ}\text{C}$  (see page 63).

Sealed bearings are greased for the entire operating period, relubrication not being necessary. Sealed bearings washing or heating before mounting in assembly is not allowed.

## Self-aligning ball bearings with extended inner ring

Self-aligning ball bearings with extended inner ring of series 112 and 113 are used in applications where high accuracy is not necessary and generally, they can be mounted directly on rolled shafts. The bore manufactured to tolerance class J7 allows fast mounting and dismounting. The inner ring has a groove for bearing axial location which can be done by means of a screw or pin.

## Dimensions

Overall dimensions of self-aligning ball bearings are in accordance with ISO 15.

## Misalignment

Self-aligning ball bearings allow within certain limits an angular misalignment of the outer ring in relation to the inner ring, without detrimental effects in bearing unit.

Approximate values for permissible misalignment, under normal operating conditions are given in table 1.

Permissible misalignment	
Bearing series	Permissible misalignment
	degrees
108, 126, 127, 129, 135	3
12, 112	2,5
13, 113	3
22	2,5
22-2RSR	1,5
23	3
23-2RSR	1,5

## Tolerances and radial clearance

Bearings of serial production are manufactured to normal tolerance class and with normal radial clearance. Tapered bore bearings of serial production are also manufactured with radial clearance C3.

Self-aligning ball bearings with extended inner ring are manufactured with radial clearance C2 and normal clearance.

At request, these bearings can also be manufactured to other tolerance classes and with smaller or larger radial clearance.

The bore of self-aligning ball bearings with extended inner ring is manufactured to tolerance class J7.

Bearing tolerances are given on page 27 and the values of radial clearance are given in tables 2 and 3.

Radial clearance of self-aligning ball bearings											
With cylindrical bore											
Bore diameter d		Designation of clearance group									
		C2		Normal		C3		C4		C5	
over		up to		Bearing radial clearance							
mm		min.	max.	min.	max.	min.	max.	min.	max.	min.	max.
		µm									
<b>2,5</b>	<b>6</b>	1	8	5	15	10	20	15	25	21	33
<b>6</b>	<b>10</b>	2	9	6	17	12	25	19	33	27	42
<b>10</b>	<b>14</b>	2	10	6	19	13	26	21	35	30	48
<b>14</b>	<b>18</b>	3	12	8	21	15	28	23	37	32	50
<b>18</b>	<b>24</b>	4	14	10	23	17	30	25	39	34	52
<b>24</b>	<b>30</b>	5	16	11	24	19	35	29	46	40	58
<b>30</b>	<b>40</b>	6	18	13	29	23	40	34	53	46	66
<b>40</b>	<b>50</b>	6	19	14	31	25	44	37	57	50	71
<b>50</b>	<b>65</b>	7	21	16	36	30	50	45	69	62	88
<b>65</b>	<b>80</b>	8	24	18	40	35	60	54	83	76	108
<b>80</b>	<b>100</b>	9	27	22	48	42	70	64	96	89	124
<b>100</b>	<b>120</b>	10	31	25	56	50	83	75	114	105	145
<b>120</b>	<b>140</b>	10	38	30	68	60	100	90	135	125	175
<b>140</b>	<b>160</b>	15	44	35	80	70	120	110	161	150	210
With tapered bore											
		µm									
<b>18</b>	<b>24</b>	7	17	13	26	20	33	28	42	37	55
<b>24</b>	<b>30</b>	9	20	15	28	23	39	33	50	44	62
<b>30</b>	<b>40</b>	12	24	19	35	29	46	40	59	52	72
<b>40</b>	<b>50</b>	14	27	22	39	33	52	45	65	58	79
<b>50</b>	<b>65</b>	18	32	27	47	41	61	56	80	73	99
<b>65</b>	<b>80</b>	23	39	35	57	50	75	69	98	91	123
<b>80</b>	<b>100</b>	29	47	42	68	62	90	84	116	109	144
<b>100</b>	<b>120</b>	35	56	50	81	75	108	100	139	130	170
<b>120</b>	<b>140</b>	40	68	60	98	90	130	120	165	155	205
<b>140</b>	<b>160</b>	45	74	65	110	100	150	140	191	180	240

### Equivalent dynamic radial load

$$P_r = F_r + Y_1 F_a, \text{ kN,} \quad \text{when } F_a/F_r \leq e,$$

$$P_r = 0,65 F_r + Y_2 F_a, \text{ kN} \quad \text{when } F_a/F_r > e,$$

The values of factors  $e$ ,  $Y_1$  and  $Y_2$  which depend on bearings are given in bearing tables.

### Equivalent static radial load

$$P_{Or} = F_r + Y_0 F_a, \text{ kN}$$

The values of the factor  $Y_0$  which depends on bearing are given in bearing tables.

### Axial load on bearings with adapter sleeves

If self-aligning ball bearings are mounted with adapter sleeves on smooth shafts, without side location, their axial carrying capacity depends on the friction between the sleeve bore and shaft.

Permissible axial load can be precisely enough determined using the equation:

$$F_{a \max} = 3 B d,$$

where:

$F_{a \max}$  - maximum permissible axial load, N

$B$  - bearing width, mm

$d$  - bearing bore diameter, mm

### Cages

Self-aligning ball bearings are generally fitted with presses cages of sheet. At special request, when bearings operate under fluctuating loads, at high speeds and where large sizes are required, machined brass cages are recommended to be used. Glass fiber reinforced polyamide 6.6 cages are also suitable if the operating temperatures do not exceed +120°C. They have low mass, a low coefficient of friction and are noiseless while running.

Cage design and technical data are given in table 4.

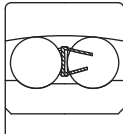
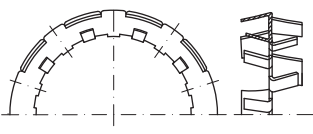
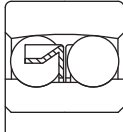
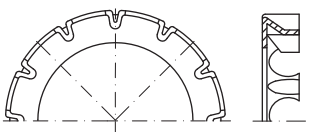
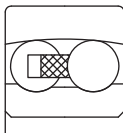
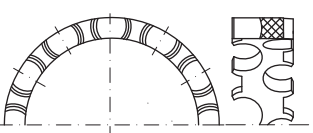
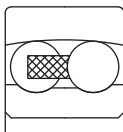
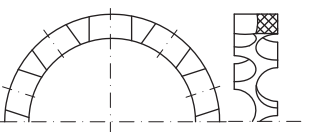
Cage design and technical data <span style="float: right;">Table 4</span>					
Cage	Design		Application	Max. value $D_m n$	
	bearing	cage		oil	grease
Pressed sheet cage			- General application - Moderate speeds - Sealed bearings series 12, 13, 22, 23	600x10 <sup>3</sup>	450x10 <sup>3</sup>
Pressed sheet cage			- General application - Moderate speeds - Bearings series 22, 23	600x10 <sup>3</sup>	450x10 <sup>3</sup>
Polyamide cage TN			- High speeds - Bearings series 12, 13, 22, 23	1000x10 <sup>3</sup>	800x10 <sup>3</sup>
Machined brass cage M			- High speeds - Bearings: 1220-1222; 1317-1322; 2217-2222; 2317-2320	900x10 <sup>3</sup>	700x10 <sup>3</sup>



### Special characteristics

In case of some dimensions of self-aligning ball bearings series 12 and 13, the balls protrude somewhat from the bearing, as shown in the adjacent design and table. This should be considered both by designer and user.

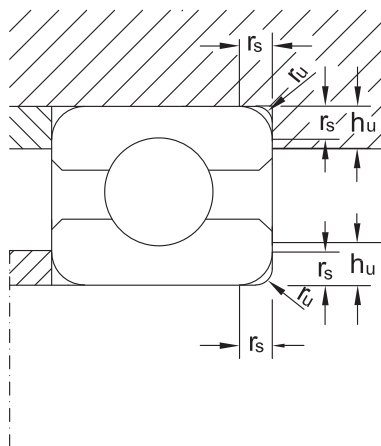
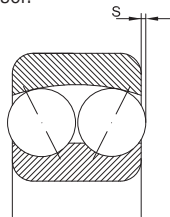

Bearing	S mm
1224	1,3
1226	0,7
1318	1
1319	1,5
1320	2,5
1321	2,6
1322	2,6

### Abutment dimensions

For a proper location of bearing rings on the shaft shoulder and housing shoulder respectively, maximum connection radius  $r_{u\max.}$  of shaft (housing) should be less than minimum mounting chamfer  $r_{s\min.}$  of bearing.

Shoulder height should also be properly sized in case of bearing maximum mounting chamfer.

In case of self-aligning ball bearings with tapered bore which are mounted directly on a tapered shaft or with an adapter sleeve, proper tightening and minimum radial clearance of 10-20  $\mu\text{m}$  should be assured for normal clearance and of 20-55  $\mu\text{m}$  for clearance C3, depending on bearing size and series. The values of the connection radius and support shoulder height are given in table 6 and mounting dimensions for bearings mounted with adapter sleeves are given in table 7.

$r_s$ min.	$r_u$ max.	$h_{u\min.}$ min.
		Bearing series 12, 13, 112, 22, 23, 113
mm		
0,3	0,2	1,2
0,6	0,6	2,1
1	1	2,8
1,1	1	3,5
1,5	1,5	4,5
2	2	5,5
2,1	2,1	6

## Self-aligning ball bearings with adapter sleeves Abutment dimensions

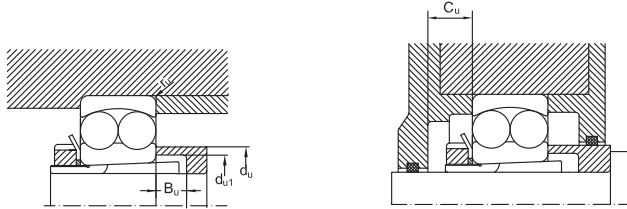
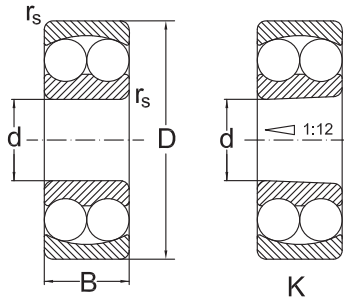

Table 7

Bore symbol	Shaft diameter	Bearing series												
		12K			22K			13K			23K			All series
		$d_{u1}$ min.	$d_u$ max.	$B_u$ min.	$d_{u1}$ min.	$d_u$ max.	$B_u$ min.	$d_{u1}$ min.	$d_u$ max.	$B_u$ min.	$d_{u1}$ min.	$d_u$ max.	$B_u$ min.	$C_u$ min.
mm														
<b>04</b>	<b>17</b>	23	27	5	23	27	5	23	30	8	24	28	5	
<b>05</b>	<b>20</b>	28	32	6	28	32	5	28	35	6	30	34	5	15
<b>06</b>	<b>25</b>	33	38	6	33	38	5	33	42	6	35	40	5	15
<b>07</b>	<b>30</b>	38	45	5	39	44	5	39	49	7	40	45	5	17
<b>08</b>	<b>35</b>	43	52	5	44	50	5	44	55	5	45	51	5	17
<b>09</b>	<b>40</b>	48	57	5	50	56	7	50	61	5	50	57	5	17
<b>10</b>	<b>45</b>	53	62	5	55	61	9	50	61	5	56	63	5	19
<b>11</b>	<b>50</b>	60	69	6	60	68	10	60	74	6	61	69	6	19
<b>12</b>	<b>55</b>	64	75	6	65	73	9	65	83	6	66	74	6	20
<b>13</b>	<b>60</b>	70	83	6	70	79	8	70	89	6	72	82	6	21
<b>14</b>	<b>60</b>	75	86	6	75	85	11	75	94	6	77	88	6	21
<b>15</b>	<b>65</b>	80	92	6	80	90	12	80	100	6	82	94	6	23
<b>16</b>	<b>70</b>	85	99	6	85	96	12	85	107	6	88	100	6	25
<b>17</b>	<b>75</b>	90	105	7	91	102	12	91	114	7	94	106	7	27
<b>18</b>	<b>80</b>	95	110	7	96	108	10	96	120	7	100	112	7	28
<b>19</b>	<b>85</b>	100	117	7	102	114	9	102	126	7	105	117	7	29
<b>20</b>	<b>90</b>	106	124	7	108	120	8	108	132	7	110	125	7	30
<b>21</b>	<b>95</b>	111	131	7										31
<b>22</b>	<b>100</b>	116	138	7										32



### Self-aligning ball bearings



Dimensions				Basic radial load. Factors						Speed limit		Designation	Mass
d	D	B	r <sub>s</sub> min.	dyn. C <sub>r</sub>	e	Y <sub>1</sub>	Y <sub>2</sub>	stat. C <sub>0r</sub>	Y <sub>0</sub>	grease	oil		
mm				kN	-			kN	-	min <sup>-1</sup>		-	Kg
<b>5</b>	19	6	0,3	2,55	0,33	1,9	3	0,48	2	30000	36000	<b>135</b>	0,01
<b>6</b>	19	6	0,3	2,5	0,33	1,9	3	0,48	2	30000	36000	<b>126</b>	0,01
<b>7</b>	22	7	0,3	2,65	0,33	1,9	3	0,56	2	30000	36000	<b>127</b>	0,01
<b>8</b>	22	7	0,3	2,65	0,33	1,9	3	0,56	2	30000	36000	<b>108</b>	0,01
<b>9</b>	26	8	0,6	3,8	0,33	1,9	3	0,8	2	26000	32000	<b>129</b>	0,02
<b>10</b>	30	9	0,6	5,5	0,33	1,9	3	1,2	2	24000	30000	<b>1200</b>	0,03
	30	14	0,6	7,2	0,54	1,2	1,8	1,6	1,2	22000	28000	<b>2200</b>	0,04
	35	11	0,6	7,2	0,34	1,9	2,9	1,6	1,9	20000	26000	<b>1300</b>	0,02
<b>12</b>	32	10	0,6	5,6	0,37	1,7	2,6	1,25	1,8	22000	28000	<b>1201</b>	0,04
	32	14	0,6	7,6	0,53	1,2	1,8	1,75	1,2	20000	26000	<b>2201</b>	0,05
	37	12	1	9,4	0,35	1,8	2,8	2,15	1,9	18000	22000	<b>1301</b>	0,06
	37	17	1	9,4	0,54	1,2	1,8	2,3	1,2	17000	20000	<b>2301</b>	0,09
<b>15</b>	35	11	0,6	7,5	0,36	1,8	2,7	1,75	1,9	19000	24000	<b>1202</b>	0,04
	35	14	0,6	7,7	0,5	1,3	2	1,85	1,3	18000	22000	<b>2202</b>	0,06
	42	13	1	9,55	0,35	1,8	2,8	2,3	1,9	17000	20000	<b>1302</b>	0,09
	42	17	1	12,1	0,5	1,3	2	2,9	1,3	15000	18000	<b>2302</b>	0,11
<b>17</b>	40	12	0,6	7,9	0,32	1,9	3	2,05	2	18000	22000	<b>1203</b>	0,07
	40	16	0,6	9,8	0,5	1,3	2	2,4	1,3	17000	20000	<b>2203</b>	0,08
	47	14	1	12,5	0,34	1,8	2,9	3,15	2	14000	17000	<b>1303</b>	0,13
	47	19	1	14,5	0,49	1,3	2	3,6	1,3	13000	16000	<b>2303</b>	0,16
<b>20</b>	47	14	1	9,9	0,28	2,2	3,5	2,65	2,4	15000	18000	<b>1204</b>	0,12
	47	14	1	9,9	0,28	2,2	3,5	2,65	2,4	15000	18000	<b>1204 K</b>	0,12
	47	18	1	12,6	0,28	2,2	3,5	3,3	2,4	14000	17000	<b>2204</b>	0,14
	47	18	1	12,6	0,28	2,2	3,5	3,3	2,4	14000	17000	<b>2204 K</b>	0,14
	52	15	1,1	12,4	0,3	2,1	3,3	3,35	2,2	12000	15000	<b>1304</b>	0,16
	52	15	1,1	12,4	0,3	2,1	3,3	3,35	2,2	12000	15000	<b>1304 K</b>	0,16
	52	21	1,1	18,2	0,52	1,2	1,9	4,7	1,3	11000	14000	<b>2304</b>	0,21
	52	21	1,1	18,2	0,52	1,2	1,9	4,7	1,3	11000	14000	<b>2304 K</b>	0,21
<b>25</b>	52	15	1	12,2	0,29	2,2	3,4	3,3	2,3	13000	16000	<b>1205</b>	0,14
	52	15	1	12,2	0,29	2,2	3,4	3,3	2,3	13000	16000	<b>1205 K</b>	0,14
	52	15	1	12,2	0,29	2,2	3,4	3,3	2,3	13000	16000	<b>1205 M</b>	0,14
	52	18	1	12,5	0,43	1,5	2,3	3,45	1,6	11000	14000	<b>2205</b>	0,16
	52	18	1	12,5	0,43	1,5	2,3	3,45	1,6	11000	14000	<b>2205 K</b>	0,16
	52	18	1	12,2	0,29	2,2	3,4	3,3	2,3	7000		<b>2205 2RSR</b>	0,16
	52	18	1	12,2	0,29	2,2	3,4	3,3	2,3	7000		<b>2205 K2RSR</b>	0,16
	62	17	1,1	17,8	0,28	2,2	3,5	4,9	2,4	9500	12000	<b>1305</b>	0,26
	62	17	1,1	17,8	0,28	2,2	3,5	4,9	2,4	9500	12000	<b>1305 K</b>	0,26
	62	24	1,1	24,5	0,44	1,4	2,2	6,55	1,5	9500	12000	<b>2305</b>	0,34

## Self-aligning ball bearings

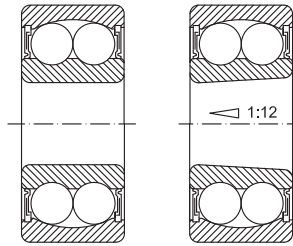

2RSR

K2RSR

Dimensions				Basic radial load. Factors						Speed limit		Designation	Mass	
d	D	B	r <sub>s</sub> min.	dyn. C <sub>r</sub>	e	Y <sub>1</sub>	Y <sub>2</sub>	stat. C <sub>0r</sub>	Y <sub>0</sub>	grease	oil			-
mm				kN	-			kN	-	min <sup>-1</sup>		-		
25	62	24	1,1	24,5	0,44	1,4	2,2	6,55	1,5	9500	12000	2305 K	0,34	
	62	24	1,1	17,8	0,28	2,2	3,5	4,9	2,4	6300		2305 2RSR	0,33	
30	62	16	1	15,7	0,25	2,5	3,9	4,7	2,7	10000	13000	1206	0,22	
	62	16	1	15,7	0,25	2,5	3,9	4,7	2,7	10000	13000	1206 K	0,22	
	62	20	1	15,3	0,4	1,6	2,5	4,6	1,7	9500	12000	2206	0,26	
	62	20	1	15,3	0,4	1,6	2,5	4,6	1,7	9500	12000	2206 K	0,26	
	62	20	1	15,3	0,4	1,6	2,5	4,6	1,7	9500	12000	2206 M	0,26	
	62	20	1	15,7	0,25	2,5	3,9	4,7	2,7	5600		2206 2RSR	0,26	
	62	20	1	15,7	0,25	2,5	3,9	4,7	2,7	5600		2206 K2RSR	0,26	
	72	19	1,1	21,4	0,24	2,6	4,1	6,35	2,8	9000	11000	1306	0,38	
	72	19	1,1	21,4	0,24	2,6	4,1	6,35	2,8	9000	11000	1306 K	0,38	
	72	27	1,1	31,4	0,4	1,6	2,5	8,7	1,7	8500	10000	2306	0,5	
	72	27	1,1	31,4	0,4	1,6	2,5	8,7	1,7	8500	10000	2306 K	0,5	
	72	27	1,1	21,4	0,24	2,6	4,1	6,35	2,8	5600		2306 2RSR	0,5	
	35	72	17	1,1	15,8	0,23	2,8	4,2	5,15	2,9	9000	11000	1207	0,32
		72	17	1,1	15,8	0,23	2,8	4,2	5,15	2,9	9000	11000	1207 K	0,32
72		17	1,1	15,8	0,23	2,8	4,2	5,15	2,9	9000	11000	1207 M	0,32	
72		23	1,1	21,7	0,37	1,7	2,6	6,7	1,8	8500	10000	2207	0,4	
72		23	1,1	21,7	0,37	1,7	2,6	6,7	1,8	8500	10000	2207 K	0,4	
72		23	1,1	15,8	0,23	2,8	4,2	5,15	2,9	5300		2207 RSR	0,4	
72		23	1,1	15,8	0,23	2,8	4,2	5,15	2,9	5300		2207 K2RSR	0,4	
80		21	1,5	25,1	0,25	2,5	3,9	7,95	2,7	7500	9000	1307	0,51	
80		21	1,5	25,1	0,25	2,5	3,9	7,95	2,7	7500	9000	1307 K	0,51	
80		31	1,5	39,7	0,43	1,5	2,3	12,9	1,6	7000	8500	2307	0,67	
40	80	31	1,5	39,7	0,43	1,5	2,3	12,9	1,6	7000	8500	2307 K	0,67	
	80	31	1,5	25,1	0,25	2,5	3,9	7,95	2,7	4500		2307 2RSR	0,67	
	80	18	1,1	19,2	0,22	2,9	4,5	6,5	3	8500	10000	1208	0,41	
	80	18	1,1	19,2	0,22	2,9	4,5	6,5	3	8500	10000	1208 K	0,41	
	80	23	1,1	22,4	0,33	1,9	3	7,4	2	7500	9000	2208	0,5	
	80	23	1,1	22,4	0,33	1,9	3	7,4	2	7500	9000	2208 K	0,5	
	80	23	1,1	22,4	0,33	1,9	3	7,4	2	7500	9000	2208 M	0,5	
	80	23	1,1	19,2	0,22	2,9	4,5	6,5	3	4800		2208 2RSR	0,5	
	80	23	1,1	19,2	0,22	2,9	4,5	6,5	3	4800		2208 K2RSR	0,5	
	90	23	1,5	29,5	0,24	2,6	4,1	9,75	2,8	6700	8000	1308	0,71	
	90	23	1,5	29,5	0,24	2,6	4,1	9,75	2,8	6700	8000	1308 K	0,71	
	90	33	1,5	44,9	0,39	1,6	2,5	15,1	1,7	6300	7500	2308	0,92	
	90	33	1,5	44,9	0,39	1,6	2,5	15,1	1,7	6300	7500	2308 K	0,92	
	90	33	1,5	44,9	0,39	1,6	2,5	15,1	1,7	6300	7500	2308 M	0,92	
90	33	1,5	29,5	0,24	2,6	4,1	9,75	2,8	4000		2308 2RSR	0,92		
45	85	19	1,1	21,8	0,21	3	4,7	7,4	3,2	7500	9000	1209	0,46	
	85	19	1,1	21,8	0,21	3	4,7	7,4	3,2	7500	9000	1209 K	0,46	



### Self-aligning ball bearings

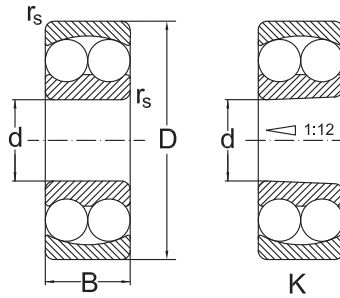

Dimensions				Basic radial load. Factors						Speed limit		Designation	Mass
d	D	B	r <sub>s</sub> min.	dyn. C <sub>r</sub>	e	Y <sub>1</sub>	Y <sub>2</sub>	stat. C <sub>0r</sub>	Y <sub>0</sub>	grease	oil		
mm				kN	-			kN	-	min <sup>-1</sup>		-	Kg
45	85	23	1,1	23,3	0,31	2	3,1	8,15	2,1	7000	8500	2209	0,54
	85	23	1,1	23,3	0,31	2	3,1	8,15	2,1	7000	8500	2209 K	0,54
	85	23	1,1	21,8	0,21	3	4,7	7,4	3,2	4500		2209 2RSR	0,54
	85	23	1,1	21,8	0,21	3	4,7	7,4	3,2	4500		2209 K2RSR	0,54
	100	25	1,5	37,7	0,24	2,6	4,1	12,9	2,8	6300	7500	1309	0,95
	100	25	1,5	37,7	0,24	2,6	4,1	12,9	2,8	6300	7500	1309 K	0,95
	100	36	1,5	54,1	0,31	2	3,1	16,5	2,1	5600	6700	2309	1,23
	100	36	1,5	54,1	0,31	2	3,1	16,5	2,1	5600	6700	2309 K	1,23
50	100	36	1,5	37,7	0,24	2,6	4,1	12,9	2,8	3600		2309 2RSR	1,23
	90	20	1,1	22,9	0,21	3	4,7	8,16	3,2	7000	8500	1210	0,52
	90	20	1,1	22,9	0,21	3	4,7	8,16	3,2	7000	8500	1210 K	0,52
	90	23	1,1	23,3	0,29	2,2	3,4	8,5	2,3	6300	7500	2210	0,59
	90	23	1,1	23,3	0,29	2,2	3,4	8,5	2,3	6300	7500	2210 K	0,59
	90	23	1,1	22,9	0,21	3	4,6	8,1	3,2	4000		2210 2RSR	0,59
	90	23	1,1	22,9	0,21	3	4,6	8,1	3,2	4000		2210 K2RSR	0,59
	110	27	2	43,4	0,24	2,6	4,1	14,2	2,8	5600	6700	1310	1,21
	110	27	2	43,4	0,24	2,6	4,1	14,2	2,8	5600	6700	1310 K	1,21
	110	40	2	64,4	0,42	1,5	2,3	20	1,6	5300	6300	2310	1,23
55	110	40	2	64,4	0,42	1,5	2,3	20	1,6	5300	6300	2310 K	1,23
	110	40	2	43,4	0,24	2,6	4,1	14,2	2,8	3400		2310 2RSR	1,64
	100	21	1,5	26,6	0,2	3,2	4,9	10,1	3,3	6300	7500	1211	0,7
	100	21	1,5	26,6	0,2	3,2	4,9	10,1	3,3	6300	7500	1211 K	0,7
	100	25	1,5	26,5	0,27	2,3	3,6	9,9	2,5	6000	7000	2211	0,81
	100	25	1,5	26,5	0,27	2,3	3,6	9,9	2,5	6000	7000	2211 K	0,81
	120	29	2	51,3	0,23	2,8	4,2	18,1	2,9	5000	6000	1311	1,58
	120	29	2	51,3	0,23	2,8	4,2	18,1	2,9	5000	6000	1311 K	1,58
	120	43	2	75,3	0,41	1,5	2,4	23,8	1,6	4800	5600	2311	2,1
	120	43	2	75,3	0,41	1,5	2,4	23,8	1,6	4800	5600	2311 K	2,1
60	110	22	1,5	30,2	0,19	3,4	5,2	11,6	3,5	5600	6700	1212	0,9
	110	22	1,5	30,2	0,19	3,4	5,2	11,6	3,5	5600	6700	1212 K	0,9
	110	28	1,5	33,8	0,28	2,2	3,5	12,6	2,4	5300	6300	2212	1,1
	110	28	1,5	33,8	0,28	2,2	3,5	12,6	2,4	5300	6300	2212 K	1,1
	130	31	2,1	57,1	0,23	2,8	4,2	20,8	2,9	4500	5300	1312	1,96
	130	31	2,1	57,1	0,23	2,8	4,2	20,8	2,9	4500	5300	1312 K	1,96
	130	46	2,1	87,1	0,41	1,5	2,4	28	1,6	4300	5000	2312	2,6
	130	46	2,1	87,1	0,41	1,5	2,4	28	1,6	4300	5000	2312 K	2,6
65	120	23	1,5	31	0,17	3,7	5,7	12,4	3,9	5300	6300	1213	1,15
	120	23	1,5	31	0,17	3,7	5,7	12,4	3,9	5300	6300	1213 K	1,15
	120	31	1,5	43,6	0,28	2,2	3,5	16,4	2,4	5000	6000	2213	1,45
	120	31	1,5	43,6	0,28	2,2	3,5	16,4	2,4	5000	6000	2213 K	1,45
	140	33	2,1	62	0,23	2,8	4,2	22,9	2,8	4300	5000	1313	2,45



## Self-aligning ball bearings

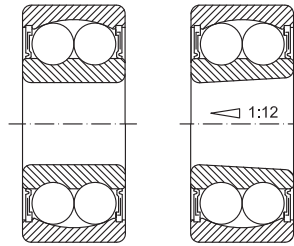

2RSR

K2RSR

Dimensions				Basic radial load. Factors						Speed limit		Designation	Mass
d	D	B	r <sub>s</sub> min.	dyn. C <sub>r</sub>	e	Y <sub>1</sub>	Y <sub>2</sub>	stat. C <sub>0r</sub>	Y <sub>0</sub>	grease	oil		
mm				kN	-			kN	-	min <sup>-1</sup>		-	-
65	140	33	2,1	62	0,23	2,8	4,2	22,9	2,8	4300	5000	1313 K	2,45
	140	48	2,1	95,6	0,38	1,7	2,6	32,5	1,7	4000	4800	2313	3,25
	140	48	2,1	95,6	0,38	1,7	2,6	32,5	1,7	4000	4800	2313 K	3,25
70	125	24	1,5	34,6	0,18	3,5	5,4	13,7	3,7	5000	6000	1214	1,25
	125	24	1,5	34,6	0,18	3,5	5,4	13,7	3,7	5000	6000	1214 K	1,25
	125	31	1,5	44,2	0,27	2,3	3,6	17,1	2,5	4800	5600	2214	1,5
	125	31	1,5	44,2	0,27	2,3	3,6	17,1	2,5	4800	5600	2214 K	1,5
	150	35	2,1	74,1	0,22	2,9	4,5	27,7	3	4000	4800	1314	3
	150	35	2,1	74,1	0,22	2,9	4,5	27,7	3	4000	4800	1314 K	3
	150	51	2,1	111	0,35	1,8	2,8	31,7	1,9	3600	4300	2314	3,9
	150	51	2,1	111	0,35	1,8	2,8	31,7	1,9	3600	4300	2314 K	3,9
75	130	25	1,5	38,9	0,18	3,5	5,4	15,6	3,7	4800	5600	1215	1,35
	130	25	1,5	38,9	0,18	3,5	5,4	15,6	3,7	4800	5600	1215 K	1,35
	130	31	1,5	44	0,25	2,5	3,9	17,8	2,7	4500	5300	2215	1,6
	130	31	1,5	44	0,25	2,5	3,9	17,8	2,7	4500	5300	2215 K	1,6
	160	37	2,1	79,2	0,22	2,9	4,5	30	3	3600	4300	1315	3,55
	160	37	2,1	79,2	0,22	2,9	4,5	30	3	3600	4300	1315 K	3,55
	160	55	2,1	123	0,38	1,7	2,6	42,8	1,7	3400	4000	2315	4,7
	160	55	2,1	123	0,38	1,7	2,6	42,8	1,7	3400	4000	2315 K	4,7
80	140	26	2	39,8	0,16	3,9	6,1	17	4,1	4300	5000	1216	1,65
	140	26	2	39,8	0,16	3,9	6,1	17	4,1	4300	5000	1216 K	1,65
	140	33	2	48,8	0,26	2,4	3,7	19,9	2,5	4000	4800	2216	2
	140	33	2	48,8	0,26	2,4	3,7	19,9	2,5	4000	4800	2216 K	2
	170	39	2,1	88,4	0,22	2,9	4,5	33	3	3400	4000	1316	4,2
	170	39	2,1	88,4	0,22	2,9	4,5	33	3	3400	4000	1316 K	4,2
	170	58	2,1	136	0,34	1,9	2,9	48,5	2	3200	3800	2316	6,1
	170	58	2,1	136	0,34	1,9	2,9	48,5	2	3200	3800	2316 K	6,1
	170	58	2,1	136	0,34	1,9	2,9	48,5	2	3200	3800	2316 M	6,1
85	150	28	2	48,2	0,17	3,7	5,7	20,8	3,9	4000	4800	1217	2,05
	150	28	2	48,2	0,17	3,7	5,7	20,8	3,9	4000	4800	1217 K	2,05
	150	36	2	58,5	0,25	2,5	3,9	23,8	2,7	3800	4800	2217	2,5
	150	36	2	58,5	0,25	2,5	3,9	23,8	2,7	3800	4800	2217 K	2,5
	180	41	3	97,5	0,22	2,9	4,5	37,9	3	3200	3800	1317	5
	180	41	3	97,5	0,22	2,9	4,5	37,9	3	3200	3800	1317 K	5
	180	60	3	140	0,37	1,7	2,6	51,5	1,8	3000	3600	2317	7,05
	180	60	3	140	0,37	1,7	2,6	51,5	1,8	3000	3600	2317 K	7,05
90	160	30	2	57	0,17	3,7	5,7	23,1	3,9	3800	4500	1218	2,5
	160	30	2	57	0,17	3,7	5,7	23,1	3,9	3800	4500	1218 K	2,5
	160	40	2	70,2	0,27	2,3	3,6	27,2	2,5	3600	4300	2218	3,4
	160	40	2	70,2	0,27	2,3	3,6	27,2	2,5	3600	4300	2218 K	3,4



### Self-aligning ball bearings

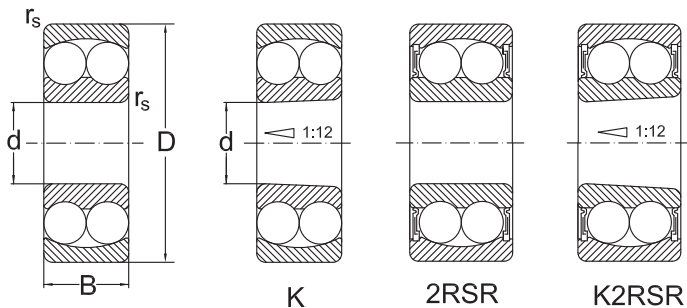

Dimensions				Basic radial load. Factors						Speed limit		Designation	Mass
d	D	B	r <sub>s</sub> min.	dyn. C <sub>r</sub>	e	Y <sub>1</sub>	Y <sub>2</sub>	stat. C <sub>0r</sub>	Y <sub>0</sub>	grease	oil		
mm				kN	-			kN	-	min <sup>-1</sup>		-	Kg
90	190	43	3	117	0,22	2,9	4,5	44,5	3	3000	3600	<b>1318</b>	5,8
	190	43	3	117	0,22	2,9	4,5	44,5	3	3000	3600	<b>1318 K</b>	5,8
	190	64	3	153	0,38	1,7	2,6	57,7	1,7	2800	3400	<b>2318</b>	8,45
	190	64	3	153	0,38	1,7	2,6	57,7	1,7	2800	3400	<b>2318 K</b>	8,45
95	170	32	2,1	63,7	0,17	3,7	5,7	24,3	3,9	3400	4000	<b>1219</b>	3,1
	170	32	2,1	63,7	0,17	3,7	5,7	24,3	3,9	3400	4000	<b>1219 K</b>	3,1
	200	45	3	133	0,23	2,8	4,2	50,8	2,9	2800	3400	<b>1319</b>	6,7
	200	45	3	133	0,23	2,8	4,2	50,8	2,9	2800	3400	<b>1319 K</b>	6,7
100	180	34	2,1	68,9	0,17	3,7	5,7	29,7	3,9	3200	3800	<b>1220</b>	3,7
	180	34	2,1	68,9	0,17	3,7	5,7	29,7	3,9	3200	3800	<b>1220 K</b>	3,7
	180	46	2,1	97,5	0,24	2,6	4,1	34	2,8	3200	3800	<b>2220</b>	5
	180	46	2,1	97,5	0,24	2,6	4,1	34	2,8	3200	3800	<b>2220 K</b>	5
	215	47	3	143	0,24	2,6	4,1	57,3	2,8	2600	3200	<b>1320</b>	8,3
	215	47	3	143	0,24	2,6	4,1	57,3	2,8	2600	3200	<b>1320 K</b>	8,3
	215	73	3	193	0,34	1,9	2,9	73,4	2	2400	3000	<b>2320</b>	12,2
110	200	38	2,1	88	0,17	3,7	5,7	35,2	3,9	2800	3400	<b>1222</b>	5,15
	200	38	2,1	88	0,17	3,7	5,7	35,2	3,9	2800	3400	<b>1222 K</b>	5,15
	200	53	2,1	124	0,26	2,4	3,7	48,9	2,5	2800	3400	<b>2222</b>	7,1
	200	53	2,1	124	0,26	2,4	3,7	48,9	2,5	2800	3400	<b>2222 K</b>	7,1
	240	50	3	163	0,22	2,9	4,5	67,5	3	2400	3000	<b>1322</b>	12
	240	50	3	163	0,22	2,9	4,5	67,5	3	2400	3000	<b>1322 K</b>	12

## Self-aligning ball bearings with extended inner ring

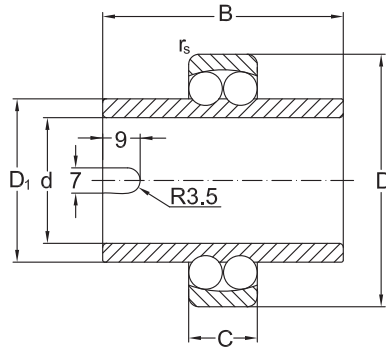

Dimensions						Basic radial load. Factors						Speed limit		Designation	Mass	
d <sup>1)</sup>	D	C	B	D <sub>1</sub>	r <sub>s</sub> min.	dyn. C <sub>r</sub>	e	Y <sub>1</sub>	Y <sub>2</sub>	stat. C <sub>0r</sub>	Y <sub>0</sub>	grease	oil			
mm						kN	-				kN	-	min <sup>-1</sup>		-	Kg
20	47	14	40	29,2	1	9,9	0,28	2,2	3,5	2,65	2,4	7100	9000	<b>11204</b>	0,18	
	52	15	44	31,5	1,1	12,4	0,3	2,1	3,3	3,35	2,2	8000	6300	<b>11304</b>	0,27	
25	52	15	44	33,3	1	12,2	0,29	2,2	3,4	3,3	2,3	6300	8000	<b>11205</b>	0,22	
	62	17	48	38	1,1	17,8	0,28	2,2	3,5	4,9	2,4	5000	6300	<b>11305</b>	0,41	
30	62	16	48	40,1	1	15,7	0,25	2,5	3,9	4,7	2,7	5000	6300	<b>11206</b>	0,35	
	72	19	52	45	1,1	21,4	0,24	2,6	4,1	6,35	2,8	4000	5000	<b>11306</b>	0,61	
35	72	17	52	47,7	1,1	15,8	0,23	2,8	4,2	5,15	2,9	4000	5000	<b>11207</b>	0,54	
	80	21	56	51,7	1,5	25,1	0,25	2,5	3,9	7,95	2,7	3600	4500	<b>11307</b>	0,81	
40	80	18	56	54	1,1	19,2	0,22	2,9	4,5	6,5	3	3600	4500	<b>11208</b>	0,72	
	90	23	58	57,7	1,5	29,5	0,24	2,6	4,1	9,75	2,8	3200	4000	<b>11308</b>	1,08	
45	85	19	58	57,7	1,1	21,8	0,21	3	4,7	7,4	3,2	3600	4500	<b>11209</b>	0,77	
	100	25	60	63,9	1,5	37,7	0,24	2,6	4,1	12,8	2,8	2800	3600	<b>11309</b>	1,38	
50	90	20	58	62,7	1,1	22,9	0,21	3	4,7	8,1	3,2	3200	4000	<b>11210</b>	0,85	
	110	27	62	70,3	2	43,4	0,24	2,6	4,1	14,1	2,8	2500	3200	<b>11310</b>	1,72	
55	100	21	60	69,5	1,5	26,6	0,2	3,2	4,9	10	3,3	2800	3600	<b>11211</b>	1,13	
60	110	22	62	78	1,5	30,2	0,19	3,4	5,2	11,6	3,5	2500	3200	<b>11212</b>	1,5	

1) Tolerance J7



### Self-aligning ball bearings with adapter sleeve

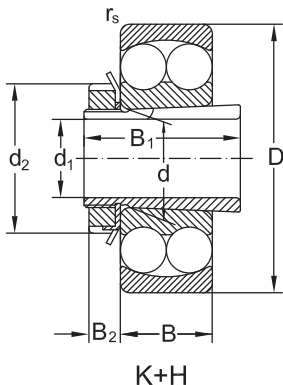

Dimensions								Designation		Mass
d <sub>1</sub>	d	D	B	r <sub>s</sub> min.	d <sub>2</sub>	B <sub>1</sub>	B <sub>2</sub>	bearing	adapter sleeve	
mm								-		Kg
17	20	47	14	1	32	24	7	<b>1204 K</b>	<b>H204</b>	0,167
	20	47	18	1	32	28	7	<b>2204 K</b>	<b>H304</b>	0,201
	20	52	15	1,1	32	28	7	<b>1304 K</b>	<b>H304</b>	0,221
	20	52	21	1,1	32	31	7	<b>2304 K</b>	<b>H2304</b>	0,281
20	25	52	15	1	38	26	8	<b>1205 K</b>	<b>H205</b>	0,219
	25	52	18	1	38	29	8	<b>2205 K</b>	<b>H305</b>	0,233
	25	52	18	1	38	29	8	<b>2205 K2RSR</b>	<b>H305</b>	0,236
	25	62	17	1,1	38	29	8	<b>1305 K</b>	<b>H305</b>	0,227
	25	62	24	1,1	38	35	8	<b>2305 K</b>	<b>H2305</b>	0,414
25	30	62	16	1	45	27	8	<b>1206 K</b>	<b>H206</b>	0,33
	30	62	20	1	45	31	8	<b>2206 K</b>	<b>H306</b>	0,363
	30	62	20	1	45	31	8	<b>2206 K2RSR</b>	<b>H306</b>	0,363
	30	72	19	1,1	45	31	8	<b>1306 K</b>	<b>H306</b>	0,49
	30	72	27	1,1	45	38	8	<b>2306 K</b>	<b>H2306</b>	0,615
30	35	72	17	1,1	52	29	9	<b>1207 K</b>	<b>H207</b>	0,422
	35	72	23	1,1	52	35	9	<b>2207 K</b>	<b>H307</b>	0,538
	35	72	23	1,1	52	35	9	<b>2207 K2RSR</b>	<b>H307</b>	0,538
	35	80	21	1,5	52	35	9	<b>1307 K</b>	<b>H307</b>	0,644
	35	80	31	1,5	52	43	9	<b>2307 K</b>	<b>H2307</b>	0,822
35	40	80	18	1,1	58	31	10	<b>1208 K</b>	<b>H208</b>	0,585
	40	80	23	1,1	58	36	10	<b>2208 K</b>	<b>H308</b>	0,683
	40	80	23	1,1	58	36	10	<b>2208 K2RSR</b>	<b>H308</b>	0,683
	40	90	23	1,1	58	36	10	<b>1308 K</b>	<b>H308</b>	0,893
	40	90	33	1,5	58	46	10	<b>2308 K</b>	<b>H2308</b>	1,13
40	45	85	19	1,1	65	33	11	<b>1209 K</b>	<b>H209</b>	0,686
	45	85	23	1,1	65	39	11	<b>2209 K</b>	<b>H309</b>	0,781
	45	85	23	1,1	65	39	11	<b>2209 K2RSR</b>	<b>H309</b>	0,781
	45	100	25	1,5	65	39	11	<b>1309 K</b>	<b>H309</b>	1,19
	45	100	36	1,5	65	50	11	<b>2309 K</b>	<b>H2309</b>	1,48
45	50	90	20	1,1	70	35	12	<b>1210 K</b>	<b>H210</b>	0,789
	50	90	23	1,1	70	42	12	<b>2210 K</b>	<b>H310</b>	0,88
	50	90	23	1,1	70	42	12	<b>2210 K2RSR</b>	<b>H310</b>	0,88
	50	110	27	2	70	42	12	<b>1310 K</b>	<b>H310</b>	1,49
	50	110	40	2	70	55	12	<b>2310 K</b>	<b>H2310</b>	1,96
50	55	100	21	1,5	75	37	12	<b>1211 K</b>	<b>H211</b>	1
	55	100	25	1,5	75	45	12	<b>2211 K</b>	<b>H311</b>	1,2

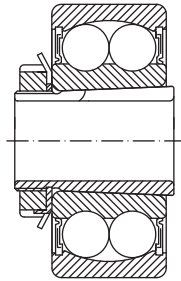

K2RSR+H

Basic radial load. Factors						Speed limit	
dyn. $C_r$	e	$Y_1$	$Y_2$	stat. $C_{0r}$	$Y_0$	grease	oil
kN		-		kN	-	min <sup>-1</sup>	
9,9	0,28	2,2	3,5	2,65	2,4	15000	18000
12,6	0,28	2,2	3,5	3,3	2,4	14000	17000
12,4	0,3	2,1	3,3	3,35	2,2	12000	15000
18,2	0,52	1,2	1,9	4,7	1,3	11000	14000
12,2	0,29	2,2	3,4	3,3	2,3	13000	16000
12,5	0,43	1,5	2,3	3,45	1,6	11000	14000
12,2	0,29	2,2	3,4	3,3	2,3	7000	
17,8	0,28	2,2	3,5	4,9	2,4	9500	12000
24,5	0,44	1,4	2,2	6,55	1,5	9500	12000
15,7	0,25	2,5	3,9	4,7	2,7	10000	13000
15,3	0,4	1,6	2,5	4,6	1,7	9500	12000
15,7	0,25	2,5	3,9	4,7	2,7	5300	
21,4	0,24	2,6	4,1	6,35	2,8	9000	11000
31,4	0,4	1,6	2,5	8,7	1,7	8500	10000
15,8	0,23	2,8	4,2	5,15	2,9	9000	11000
21,7	0,37	1,7	2,6	6,7	1,8	8500	10000
15,8	0,23	2,8	4,2	5,15	2,9	5600	
25,1	0,25	2,5	3,9	7,95	2,7	7500	9000
39,7	0,43	1,5	2,3	12,9	1,6	7000	8500
19,2	0,22	2,9	4,5	6,5	3	8500	10000
22,4	0,33	1,9	3	7,4	2	7500	9000
19,2	0,22	2,9	4,5	6,5	3	4800	
29,5	0,24	2,6	4,1	9,75	2,8	6700	8000
44,9	0,39	1,6	2,5	15,1	1,7	6300	7500
21,8	0,21	3	4,7	7,4	3,2	7500	9000
23,3	0,31	2	3,1	8,15	2,1	7000	8500
21,8	0,21	3	4,7	7,4	3,2	4500	
37,7	0,24	2,6	4,1	12,9	2,8	6300	7500
54,1	0,31	2	3,1	16,5	2,1	5600	6700
22,9	0,21	3	4,7	8,16	3,2	7000	8500
23,3	0,29	2,2	3,4	8,5	2,3	6300	7500
22,9	0,21	3	4,6	8,1	3,2	4000	
43,4	0,24	2,6	4,1	14,2	2,8	5600	6700
64,4	0,42	1,5	2,3	20	1,6	5300	6300
26,6	0,2	3,2	4,1	10,1	3,3	6300	7500
26,5	0,27	2,3	3,6	9,9	2,5	6000	7000



Self-aligning ball bearings with adapter sleeve

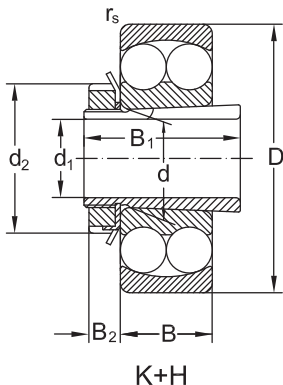

Dimensions								Designation		Mass
d <sub>1</sub>	d	D	B	r <sub>s</sub> min.	d <sub>2</sub>	B <sub>1</sub>	B <sub>2</sub>	bearing	adapter sleeve	
mm								-		Kg
50	55	120	29	2	75	45	12	<b>1311 K</b>	<b>H311</b>	1,91
	55	120	43	2	75	59	12	<b>2311 K</b>	<b>H2311</b>	2,47
55	60	110	22	1,5	80	38	13	<b>1212 K</b>	<b>H212</b>	1,03
	60	110	28	1,5	80	47	13	<b>2212 K</b>	<b>H312</b>	1,55
	60	130	31	2,1	80	47	13	<b>1312 K</b>	<b>H312</b>	2,32
	60	130	46	2,1	80	62	13	<b>2312 K</b>	<b>H2312</b>	3,01
60	65	120	23	1,5	85	40	14	<b>1213 K</b>	<b>H213</b>	1,53
	65	120	31	1,5	85	50	14	<b>2213 K</b>	<b>H313</b>	2
	65	140	33	2,1	85	50	14	<b>1313 K</b>	<b>H313</b>	2,87
	65	140	48	2,1	85	65	14	<b>2313 K</b>	<b>H2313</b>	3,71
65	75	130	25	1,5	98	43	15	<b>1215 K</b>	<b>H215</b>	2,05
	75	130	31	1,5	98	55	15	<b>2215 K</b>	<b>H315</b>	2,52
	75	160	37	2,1	98	55	15	<b>1315 K</b>	<b>H315</b>	4,34
	75	160	55	2,1	98	73	15	<b>2315 K</b>	<b>H2315</b>	5,66
70	80	140	26	2	105	46	17	<b>1216 K</b>	<b>H216</b>	2,52
	80	140	33	2	105	59	17	<b>2216 K</b>	<b>H316</b>	3,18
	80	170	39	2,1	105	59	17	<b>1316 K</b>	<b>H316</b>	5,33
	80	170	58	2,1	105	78	17	<b>2316 K</b>	<b>H2316</b>	7,24
75	85	150	28	2	110	50	18	<b>1217 K</b>	<b>H217</b>	3,06
	85	150	36	2	110	63	18	<b>2217 K</b>	<b>H317</b>	3,85
	85	180	41	3	110	63	18	<b>1317 K</b>	<b>H317</b>	6,27
	85	180	60	3	110	82	18	<b>2317 K</b>	<b>H2317</b>	8,34
80	90	160	30	2	120	52	18	<b>1218 K</b>	<b>H218</b>	3,67
	90	160	40	2	120	65	18	<b>2218 K</b>	<b>H318</b>	4,74
	90	190	43	3	120	65	18	<b>1318 K</b>	<b>H318</b>	7,36
	90	190	64	3	120	86	18	<b>2318 K</b>	<b>H2318</b>	9,94
85	95	170	32	2,1	125	55	19	<b>1219 K</b>	<b>H219</b>	4,42
	95	200	45	3	125	68	19	<b>1319 K</b>	<b>H319</b>	8,3
90	100	180	34	2,1	130	58	20	<b>1220 K</b>	<b>H220</b>	5,13
	100	180	46	2,1	130	71	20	<b>2220 K</b>	<b>H320</b>	6,63
	100	215	47	3	130	71	20	<b>1320 K</b>	<b>H320</b>	9,96
	100	215	73	3	130	97	20	<b>2320 K</b>	<b>H2320</b>	14,3
100	110	200	38	2,1	145	63	21	<b>1222 K</b>	<b>H222</b>	7
	110	200	53	2,1	145	77	21	<b>2222 K</b>	<b>H322</b>	9,15
	110	240	50	3	145	77	21	<b>1322 K</b>	<b>H322</b>	13,9

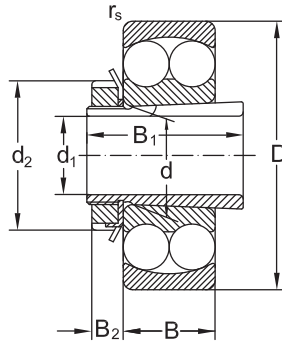

K+H

Basic radial load. Factors						Speed limit	
dyn. $C_r$	e	$Y_1$	$Y_2$	stat. $C_{or}$	$Y_0$	grease	oil
kN		-		kN	-	min <sup>-1</sup>	
51,3	0,23	2,8	4,2	18,1	2,9	5000	6000
75,3	0,41	1,5	2,4	23,8	1,6	4800	5600
30,2	0,19	3,4	5,2	11,6	3,5	5600	6700
33,8	0,28	2,2	3,5	12,6	2,4	5300	6300
57,1	0,23	2,8	4,2	20,8	2,9	4500	5300
87,1	0,41	1,5	2,4	28	1,6	4300	5000
31	0,17	3,7	5,7	12,4	3,9	5300	6300
43,6	0,28	2,2	3,5	16,4	2,4	5000	6000
62	0,23	2,8	4,2	22,9	2,8	4300	5000
95,6	0,38	1,7	2,6	32,5	1,7	4000	4800
38,9	0,18	3,5	5,4	15,6	3,7	4800	5600
44	0,25	2,5	3,9	17,8	2,7	4500	5300
79,2	0,22	2,9	4,5	30	3	3600	4300
123	0,38	1,7	2,6	42,8	1,7	4300	4000
39,8	0,16	3,9	6,1	17	4,1	4300	5000
48,8	0,26	2,4	3,7	19,9	2,5	4000	4800
88,4	0,22	2,9	4,5	33	3	3400	4000
136	0,34	1,9	2,9	48,5	2	3200	3800
48,8	0,17	3,7	5,7	20,8	3,9	4000	4800
58,5	0,25	2,5	3,9	23,8	2,7	3800	4500
97,5	0,22	2,9	4,5	37,9	3	3200	3800
140	0,37	1,7	2,6	51,5	1,8	3000	3600
57	0,17	3,7	5,7	23,1	3,9	3800	4500
70,2	0,27	2,3	3,6	27,2	2,5	3600	4300
117	0,22	2,9	4,5	44,5	3	3000	3600
153	0,38	1,7	2,6	57,7	1,7	2800	3400
63,7	0,17	3,7	5,7	24,3	3,9	3400	4000
133	0,23	2,8	4,2	50,8	2,9	2800	3400
68,9	0,17	3,7	5,7	29,7	3,9	3200	3800
97,5	0,24	2,6	4,1	34	2,8	2200	3800
143	0,24	2,6	4,1	57,3	2,8	2600	3200
193	0,34	1,9	2,9	73,4	2	2400	3000
88	0,17	3,7	5,7	35,2	3,9	2800	3400
124	0,26	2,4	3,7	48,9	2,5	2800	3400
163	0,22	2,9	4,5	67,5	3	2400	3000

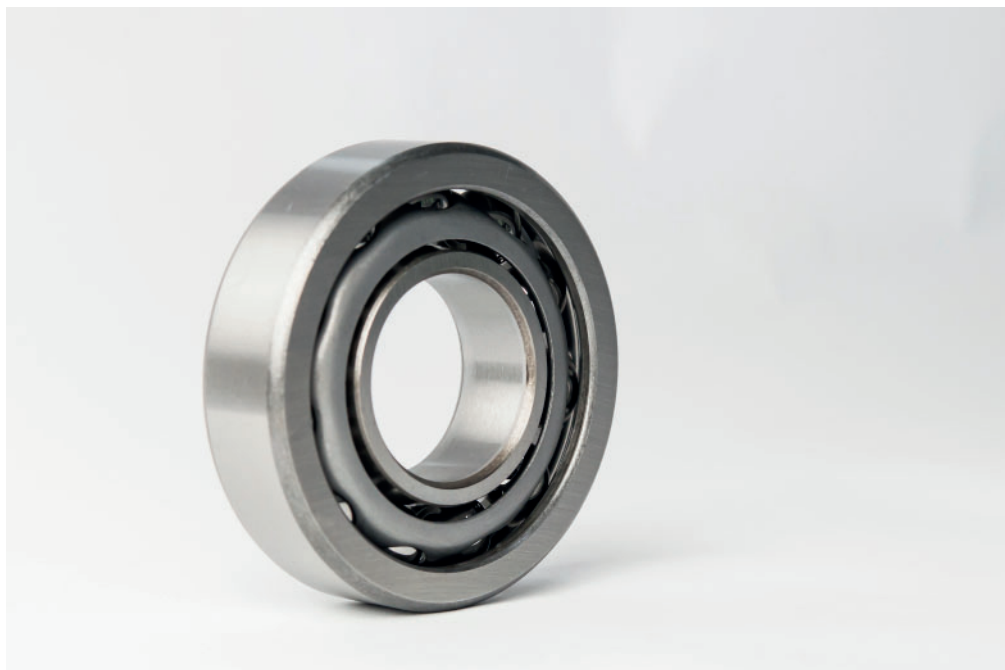



# Angular contact ball bearings, single row

Single row angular contact bearings are manufactured in various constructive versions, with various contact angles, depending on the application. Bearings series 72B and 73B for general applications have a contact angle  $\alpha = 40^\circ$ . Bearings series 718, 719, 70 and 72 generally used for tool-holders, have

phenol resins (textolite) cages or machined brass cages. Those with bore diameters up to  $d = 100$  mm are manufactured to tolerance classes P5, P4 and P2 and have a contact angle of  $15^\circ(C)$  and  $25^\circ(A)$  respectively.

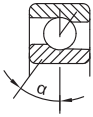

Series 72B, 73B  
Contact angle  $\alpha = 40^\circ$

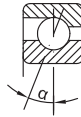

Series 70A, 72A  
Contact angle  $\alpha = 25^\circ$

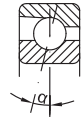

Series 70C, 72C  
Contact angle  $\alpha = 15^\circ$

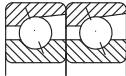

DT arrangement (Tandem)

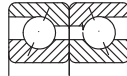

DB arrangement  
(Back-to-back)

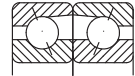

DF arrangement  
(Face-to-face)

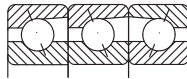

TFT arrangement

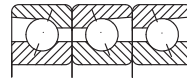

TBT arrangement

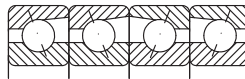

QFC arrangement



## Suffixes

- A** - bearing with extended outer ring
- A** - bearing with contact angle  $\alpha = 25^\circ$
- B** - bearing with extended outer ring
- B** - bearing with contact angle  $\alpha = 40^\circ$
- BB** - bearing with  $\alpha = 40^\circ$  and extended inner ring
- C** - bearing with contact angle  $\alpha = 15^\circ$
- CA** - bearing with radial clearance smaller than normal
- CB** - bearing with normal radial clearance
- CC** - radial bearing with axial clearance larger than normal
- D** - two bearings set D - bearing with two-pieces inner ring
- DB** - two bearings set in back-to-back arrangement, (O)
- DF** - two bearings set in face-to-face arrangement, (X)
- DT** - two bearings set in tandem arrangement
- E** - bearing with contact angle  $\alpha = 20^\circ$
- FA** - bearing with machined cage of steel or cast iron, guided in the outer ring
- FB** - bearing with machined cage of steel or cast iron, guided on the inner ring
- GA** - light preload, bearings series 72B, 73B
- GB** - moderate preload, bearings series 72B, 73B
- GC** - heavy preload, bearings series 72B, 73B
- L** - light preload, bearings series 70C, 70A, 72A
- M** - moderate preload, bearings series 70C, 70A, 72A
- M** - machined brass cage, ball guided
- MA** - machined brass cage, guided in the outer ring
- MB** - machined brass cage, guided in the inner ring
- O** - bearing set without axial clearance
- PO** - normal tolerance class
- P6** - tolerance class more accurate than normal
- P5** - tolerance class more accurate than P6
- P4** - tolerance class more accurate than P5
- P2** - tolerance class more accurate than P4
- Q** - four bearings set
- QFC** - tandem pairs in X arrangement
- S** - heavy preload, bearings series 70C, 70A, 72A
- SO** - bearings operating up to a temperature of + 150°C

- S1** - bearings operating up to a temperature of + 200°C
- T** - three bearings set
- T** - bearing set total width (T168, T200)
- TBT** - three bearings set in O arrangement, plus T
- TFT** - three bearings set in X arrangement, plus T
- TN** - polyamide cage
- V** - full complement bearing
- U** - bearings of universal design, with deviations of  $d$  and  $D$  and  $K_r$ ,  $K_e$  in P2 class
- UA** - bearings with small axial clearance at DB and DF arrangements
- UL** - bearings with light preload at DB and DF arrangements
- UO** - bearings without small axial clearance at DB and DF arrangements
- UP** - tolerance class with deviations of  $d$  and  $D$  in P4 class and of  $K_r$  and  $K_e$  in P2 class.

Single row angular contact ball bearings can take only one direction axial loads. When being radially loaded, in bearing occurs an axially acting load which has to be compensated.

For this reason, a bearing or paired bearings are mounted on each shaft end.

Single row angular contact ball bearings with B suffix have a contact angle  $\alpha = 40^\circ$  and are suitable in case of heavy loads.

These bearings are not dismountable and their use at relatively high speeds is allowed.

Pair mounting of bearings as shown in figures on page 133 is used when the load carrying capacity of a single bearing is inadequate (tandem arrangement), respectively when axial loads have to be taken in both directions (DB or DF arrangements).

In case of DT tandem arrangement, the contact lines are in parallel. Radial and axial loads are uniformly distributed on both bearings. The bearing pair can take axial loads in only one direction. Therefore, a third bearing should take axial loads in the opposite direction.

DB arrangement is considered to be a relatively stiff arrangement and can also take tilting moments.

The contact lines of DF arrangement converge

towards the bearing axis and form letter “X”. Axial loads are taken in the same way as in case of DB arrangement, but the arrangement is not so stiff and it is less suitable for taking tilting moments.

## Universal design

Single row angular contact ball bearings of universal design are suitable for DB, DF and DT arrangements.

Bearings of universal design are manufactured to more accurate tolerance classes and can be matched if the mounting conditions UA, UO and UL are observed.

The values of clearance or preload are obtained when the shaft is manufactured to tolerance class J5 and the housing bore to tolerance class J6.

## Dimensions

Main dimensions of bearings given in tables are in accordance with ISO 15.

## Misalignment

In case of single row angular contact ball bearings the conditions regarding the permissible error of

alignment of the outer ring relative to the inner ring are as complex as for single row deep groove ball bearings.

When the bearings are paired in DB arrangement, angular misalignments of the outer ring in relation to the inner ring can only be accommodated between the balls and raceways by force, leading to a reduction in bearing life.

## Tolerances

Single row angular contact ball bearings of series 72B and 73B, with a contact angle  $\alpha = 40^\circ$  (B) are generally manufactured to the normal tolerance class.

At request, they also can be manufactured to normal tolerance classes P6 and P5.

The deviations of bore diameter, outside diameter and width of high accuracy single row angular contact ball bearings of universal design (UL) are given in table 1.

In case of single row angular contact ball bearings manufactured and delivered in sets of 2, 3 or 4 bearings, outside and bore diameter should be chosen considering the mean tolerance values, which are given on the package.

Deviations of main dimensions of high accuracy row angular contact bearings										Table 1
Bore										
d		$\Delta d_{mp}, \Delta D_{mp}$				$\Delta B_s$				
over	up to	low	high	low	high	low	high	low	high	
(mm)		P4		UP		P2				
-	18	-3		-3		-2	0	-250	0	
18	30	-3,5	-1,5	-3		-2	0	-250	0	
30	50	-4	-1,5	-3		-2	0	-250	0	
50	80	-5	-2	-3,5	-1,5	-3		-250	0	
80	120	-5,5	-2			-3,5	-1,5	-380	0	

## Contact angle

In case of single row angular contact ball bearings, the efforts between rings and rolling elements (contact points of rolling elements / outer or inner ring) are transmitted at an angle  $\alpha (<90^\circ)$  to a plane perpendicular to the bearing axis.

The value of this angle depends on the magnitude of the raceway radius, rolling element diameter and radial clearance in bearing, when the curvature centres of the raceway in the outer or in the inner ring are in the same plane.



### Axial clearance - preload

Axial clearance or preload can be obtained only when single row angular contact ball bearings is mounted in the assembly and depends on the location of the second bearing which assures the shaft axial guiding.

Single row angular contact ball bearings series 72B and 73B, paired mounted in DB and DF arrangements are manufactured with normal axial clearance CB, smaller than normal, CA, larger than normal, CC, or with light preload, GA, moderate preload GB, or heavy preload, GC, according to the values given in table 2.

**Axial clearance or preload of single row angular contact ball bearings series 72B and 73B, pair mounted in DB or DF arrangements**

Table 2

Bore		Axial clearance						Preload											
d		CA		CB		CC		GA			GB				GC				
over	up to	min.	max.	min.	max.	min.	max.	min.	max.	min.	max.	min.	max.	min.	max.	min.	max.	min.	max.
mm	µm							N			µm				N				
-	10	4	12	14	22	22	30	-	-	-	-	-	-	-	-	-	-	-	-
10	18	5	13	15	23	24	32	4	-4	80	-2	-10	30	330	-8	-16	230	260	
18	30	7	15	18	26	32	40	4	-4	120	-2	-10	40	480	-8	-16	340	970	
30	50	9	17	22	30	40	48	4	-4	160	-2	-10	60	630	-8	-16	450	1280	
50	80	11	23	26	38	48	60	6	-6	380	-3	-15	140	1500	-12	-24	1080	3050	
80	120	14	26	32	44	55	67	6	-6	410	-3	-15	150	1600	-12	-24	1150	3250	
120	180	17	29	35	47	62	74	6	-6	540	-3	-15	200	2150	-12	-24	1500	4300	
180	250	21	37	45	61	74	90	8	-8	940	-4	-20	330	3700	-16	-32	2650	7500	
250	315	26	42	52	68	90	106	8	-8	1080	-4	-20	380	4250	-16	-32	3000	8600	

High accuracy single row angular contact ball bearings series 70C, 70A and 72A, with a contact angle  $\alpha = 15^\circ$  (C) and  $\alpha = 25^\circ$  (A), which are generally used for grinding stone holders, paired mounted in

DB and DF arrangement, are manufactured with an initial preload. It can be: light (L), moderate (M), heavy (S). The values of these preloads are given in table 3.

**Values of axial preload of bearings of series 70C, in DB and DF arrangements**

Table 3

Bore		Axial preload											
		Series 70C			Series 72C			Series 70A			Series 72A		
d	Symbol	L	M	S	L	M	S	L	M	S	L	M	S
mm	-	N											
10	0	15	30	60	20	40	80	25	50	100	35	70	140
12	1	15	30	60	20	40	80	25	50	100	35	70	140
15	2	20	40	80	30	60	120	30	60	120	45	90	180
17	3	25	50	100	35	70	140	40	80	160	60	120	240
20	4	35	70	140	45	90	180	50	100	200	70	140	280
25	5	35	70	140	50	100	200	60	120	240	80	160	320
30	6	50	100	200	90	180	360	90	180	360	150	300	600
35	7	60	120	240	120	240	480	90	180	360	190	380	760
40	8	60	120	240	150	300	600	100	200	400	240	480	960
45	9	110	220	440	160	320	640	170	340	680	260	520	1040
50	10	110	220	440	170	340	680	180	360	720	260	520	1040
55	11	150	300	600	210	420	840	230	460	920	330	660	1320
60	12	150	300	600	250	500	1000	240	480	960	400	800	1600

Values of axial preload of bearings of series 70C, in DB and DF arrangements

Table 3 (continued)

Bore		Axial preload											
		Series 70C			Series 72C			Series 70A			Series 72A		
d	Symbol	L	M	S	L	M	S	L	M	S	L	M	S
mm	-	N											
65	13	160	320	640	290	580	1160	240	480	960	450	900	1800
70	14	200	400	800	300	600	1200	300	600	1200	480	960	1920
75	15	200	400	800	310	620	1240	310	620	1240	500	1000	2000
80	16	240	480	960	370	740	1480	390	780	1560	580	1160	2320
85	17	250	500	1000	370	740	1480	400	800	1600	600	1200	2400
90	18	300	600	1200	480	960	1920	460	920	1840	750	1500	3000
95	19	310	620	1240	520	1040	2080	480	960	1920	850	1700	3400
100	20	310	620	1240	590	1180	2360	500	1000	2000	950	1900	3800
105	21	360	720	1440	650	1300	2600	560	1120	2240	1000	2000	4000
110	22	420	840	1680	670	1340	2680	650	1300	2600	1050	2100	4200
120	24	430	860	1720	750	1500	3000	690	1380	2760	1200	2400	4800
130	26	560	1120	2240	800	1600	3200	900	1800	3600	1250	2500	5000
140	28	570	1140	2280	-	-	-	900	1800	3600	-	-	-
150	30	650	1300	2600	-	-	-	1000	2000	4000	-	-	-
160	32	730	1460	2920	-	-	-	1150	2300	4600	-	-	-
170	34	800	1600	3200	-	-	-	1250	2500	5000	-	-	-
180	36	900	1800	3600	-	-	-	1450	2900	5800	-	-	-
190	38	950	1900	3800	-	-	-	1450	2900	5800	-	-	-

Designs of single row angular contact ball bearings with clearance or initial preload are given in the figures below:

Before mounting (preload)



After mounting (preload)

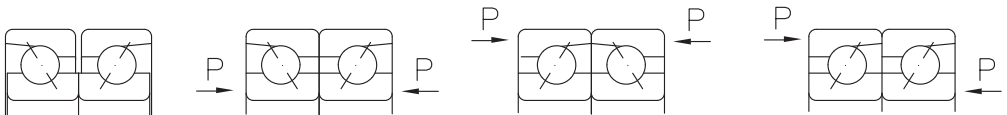

### Cages

Single row angular contact ball bearings series 72B and 73B are generally fitted with pressed sheet cages.

At special request (high speeds, large sizes), bearing series 70C, 72C, 70A and 72A are fitted

with machined brass cages. Cages of glass fibre reinforced polyamide 6.6 are also used with good results if operating temperature doesn't exceed +120°C.

Cages design and some technical data are given in table 4.



Cage design and technical data

Table 4

Cage	Design		Application	Max. value D <sub>n</sub>	
	bearing	cage		oil	grease
mm	-	N			
Pressed sheet cage			<ul style="list-style-type: none"> <li>- General application</li> <li>- Moderate speeds</li> <li>- Bearing series 72B, 73B</li> </ul>	600x10 <sup>3</sup>	450x10 <sup>3</sup>
Machined brass cage M, MA, MB			<ul style="list-style-type: none"> <li>- General application</li> <li>- High speeds</li> <li>- Bearings 7231B-7238B, 7310B-7338B</li> </ul>	1100x10 <sup>3</sup>	800x10 <sup>3</sup>
Polyamide cage TN			<ul style="list-style-type: none"> <li>- General application</li> <li>- Low friction moments</li> <li>- High speeds</li> </ul>	1100x10 <sup>3</sup>	900x10 <sup>3</sup>
Textolite cage T, TA, TB			<ul style="list-style-type: none"> <li>- High accuracy bearing series 70C, 72C, 70A, 72A</li> <li>- High speeds</li> <li>- Low vibration level</li> </ul>	1200x10 <sup>3</sup>	900x10 <sup>3</sup>

**Equivalent dynamic radial load**

For single row angular contact ball bearings series 72B and 73B, single and in tandem arrangement the following equations are used:

$$P_r = F_r, \text{ kN}, \quad \text{when } F_a/F_r < 1,14,$$

$$P_r = 0,35 F_r + 0,57 F_a, \text{ kN}, \quad \text{when } F_a/F_r > 1,14$$

For bearings in DB or DF arrangement

$$P_r = F_r + 0,65 F_a, \text{ kN} \quad \text{when } F_a/F_r < 1,14$$

$$P_r = 0,57 F_r + 0,93 F_a, \text{ kN}, \quad \text{when } F_a/F_r > 1,14$$

In case of paired bearings,  $F_r$  and  $F_a$  are the loads acting upon the bearings pair.

As the load is transmitted from one raceway to the other under a certain angle to the bearings axis, the actual load will cause an axial load. This has to be considered when calculating the equivalent dynamic load, in case of two single bearings or tandem

arrangements. The equations needed for calculation are given in table 5, for various arrangements and loading versions.

These equations are available for bearings mounted without clearance and without preload (clearance equal to zero).

For single row angular contact ball bearings series 70C and 72C with a contact angle  $\alpha = 15^\circ(\text{C})$ , single or in DT arrangement, the following equations are available:

$$P_r = F_r, \text{ kN}, \quad \text{for } F_a/F_r < e,$$

$$P_r = 0,44 F_r + Y F_a, \text{ kN}, \quad \text{for } F_a/F_r > e$$

The values of factor Y depend on the values of the ratio  $f_0 i F_a / C_{Or}$  and are given in table 6. Factor  $f_0$  can be found in diagram in page 140 as a function of dimensions series and bearing mean diameter. "i" represents the number of bearings or bearings pairs in a bearing join.

Back to back arrangement  
DB

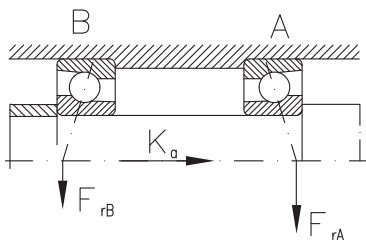

Face to face arrangement  
DF

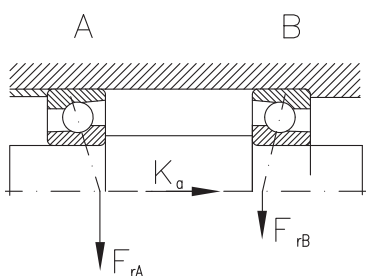

Back to back arrangement  
DB

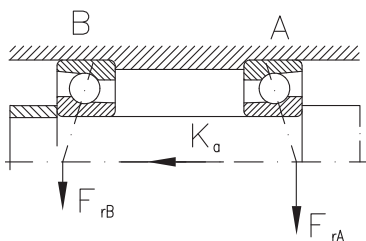

Face to face arrangement  
DF

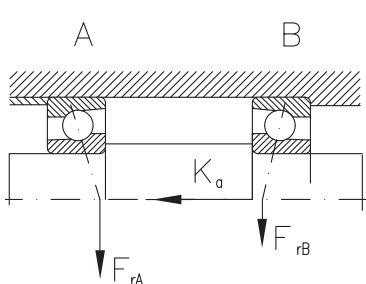

For bearings in DB and DF arrangements, the following equations are available:

$$P_r = F_r + Y_1 F_a, \text{ kN,} \quad \text{for } F_a/F_r < e,$$

$$P_r = 0,72 F_r + Y_2 F_a, \text{ kN,} \quad \text{for } F_a/F_r > e$$

The values of factors  $Y_1$  and  $Y_2$  depend on the ratio  $f_0 i F_a / C_{0r}$  and are given in table 6 ( $f_0$  from diagram below).

Determination of axial loads	
Loading version	Axial load
1a) $F_{rA} \geq F_{rB}$ $K_a \geq 0$	$F_{aA} = 1,14 F_{rA}$ $F_{aB} = F_{aA} + K_a$
1b) $F_{rA} < F_{rB}$ $K_a \geq 1,14 (F_{rB} - F_{rA})$	$F_{aA} = 1,14 F_{rA}$ $F_{aB} = F_{aA} + K_a$
1c) $F_{rA} < F_{rB}$ $K_a \leq 1,14 (F_{rB} - F_{rA})$	$F_{aB} = F_{aB} - K_a$ $F_{aA} = 1,14 F_{rB}$
2a) $F_{rA} \leq F_{rB}$ $K_a \geq 0$	$F_{aB} = F_{aB} + K_a$ $F_{aA} = 1,14 F_{rB}$
2b) $F_{rA} > F_{rB}$ $K_a \geq 1,14 (F_{rA} - F_{rB})$	$F_{aB} = F_{aB} + K_a$ $F_{aA} = 1,14 F_{rB}$
2c) $F_{rA} > F_{rB}$ $K_a < 1,14 (F_{rA} - F_{rB})$	$F_{aA} = 1,14 F_{rA}$ $F_{aB} = F_{aA} - K_a$



For single row angular contact ball bearings series 70A and 72A, with a contact angle  $\alpha = 25^\circ$ , single or in DT arrangement, the following equation are available:

$$P_r = F_r, \text{ kN, for } F_a/F_r < 0,68$$

$$P_r = 0,41 F_r + 0,87 F_a, \text{ kN, for } F_a/F_r > 0,68$$

For bearings in DB and DF arrangement, the following equations are available:

$$P_r = F_r + Y_1 F_a, \text{ kN, for } F_a/F_r < e$$

$$P_r = 0,72 F_r + Y_2 F_a, \text{ kN, for } F_a/F_r > e$$

Values for  $Y_1$  and  $Y_2$  are given in table 6.

Values of factors e, Y, $Y_1$ and $Y_2$				
Table 6				
$\frac{f_0 i F_a}{C_{Or}}$	Single and DT		Arrangement DB or DF	
	e	Y	$Y_1$	$Y_2$
0,2	0,38	1,46	1,64	2,37
0,4	0,41	1,36	1,52	2,21
0,8	0,44	1,28	1,44	2,11
1,6	0,48	1,16	1,31	1,90
3	0,52	1,08	1,21	1,78
6	0,56	1	1,12	1,66

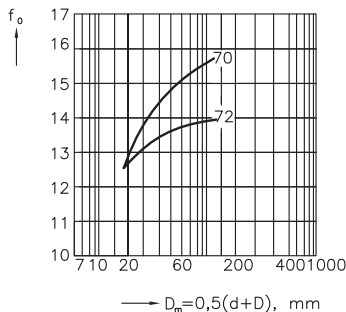

**Equivalent static load**

For single row angular contact ball bearings series 72B and 73B with a contact angle  $\alpha = 40^\circ$ , single and in DT arrangement, the following equation is available:

$$P_{Or} = 0,6 F_r + 0,26 F_a, \text{ kN}$$

If  $P_{Or} < F$  then we consider  $P_0 = F_r$

For bearings in DB and DT arrangement, the following equation is available:

$$P_{Or} = F_r + 0,52 F_a, \text{ kN}$$

For single row angular contact ball bearings series

70C and 72C, with a contact angle  $\alpha = 15^\circ$ , single and in DT arrangement, the following equation is available:

$$P_{Or} = 0,5 F_r + 0,46 F_a, \text{ kN}$$

For bearings in DB and DF arrangement, the following equation is available:

$$P_{Or} = 0,5 F_r + 0,92 F_a, \text{ kN}$$

For single row angular contact ball bearings series 70A and 72A with a contact angle  $\alpha = 25^\circ$ , single and in DT arrangement, the following equation is available:

$$P_{Or} = 0,5 F_r + 0,38 F_a, \text{ kN}$$

For bearings in DB and DF arrangement, the following equation is available:

$$P_{Or} = F_r + 0,76 F_a, \text{ kN}$$

Two “V” scratches are marked on the outside surface where the runout is maximum, i.e. where the outer ring thickness is maximum, so that the bearings of a set can be mounted in the manufacturing order. The place of maximum runout is marked on the chamfer between the inner ring bore and side face. Thus, the possible fit ovalnesses on the shaft can be compensated.

Every set is delivered as a unit, separately packed. In each unit, bearings are singly packed.

If distance rings are necessary to be mounted between bearings, they have not to be adjusted when being mounted. There is only one condition to be observed: the inner distance ring width should be equal to that of the outer ring, the side faces being parallel to each other. This can be easily done if both distance rings are simultaneously ground on a grinding and lapping machine. If bearings are mounted with distance rings, the mounting is also done observing the “V” marked as mentioned above. The cone vertex should be on the ring side opposite to that one on which the load acts (see next figure).

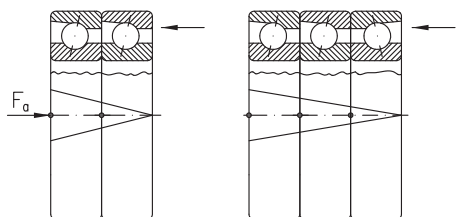



## Basic dynamic load of paired bearings

Basic dynamic load given in bearings tables is valid for each single bearing. Basic dynamic load of a paired bearings set can be determined according to the specifications on page 20-21.

## Basic static load of paired bearings

Basic static load of paired bearings can be similarly determined, multiplying the values of CO<sub>r</sub> in the tables by 2, 3 and 4 respectively.

## Bearing speed limit

Single row angular contact ball bearings are used at high speeds.

The values of speeds for bearings series 72B and 73B, normal tolerance class, without preload are given in this catalogue.

In case of preloaded bearings, for single mounted bearing and bearings in DB, DF or DT arrangements, speed should be multiplied by the coefficients in table 7.

For bearings series 70C, 72C, 70A and 72A, speeds are given for the tolerance class P4 and light preload.

In case of bearings with other values of preloads or arrangements of 3 or 4 bearing sets, the speeds of the bearing of basic design should be multiplied by the values of the coefficients in table 7.

Arrangement	Bearing preload			
	UA, UO	L	M	S
Single	1,0	1,0	0,90	0,80
Tandem, DT	0,90	0,90	0,80	0,65
Back-to-back, DB	0,80	0,80	0,70	0,55
Face-to-face, DF	0,80	0,75	0,60	0,40
Three bearings set	0,75	0,70	0,55	0,35
Four bearings set	0,70	0,65	0,45	0,25

## Abutment dimensions

For a proper location of bearing rings on the shaft and housing shoulder respectively, shaft (housing) maximum connection radius  $r_{u\max}$  should be less than bearing minimum mounting chamfer  $r_{1\min}, r_{2\min}$ .

Shoulder height should also be properly sized in case of bearing maximum mounting chamfer.

The values of the connection radii and support shoulder height are given in table 8.

$r_{s1}, r_{1s}$ min	$r_{s2}, r_{2s}$ max	$h_u, h_{u1}$ min	
		Bearing series	
		718, 728, 719, 729, 70	72 73
mm			
<b>0,3</b>	0,3	1	1,2
<b>0,6</b>	0,6	1,6	2,1
<b>1</b>	1	2,3	2,6
<b>1,1</b>	1	3	3,5
<b>1,5</b>	1,5	3,5	4,5
<b>2</b>	2	4,4	5,5
<b>2,1</b>	2,1	5,1	6
<b>3</b>	2,5	6,2	7
<b>4</b>	3	7,3	8,5

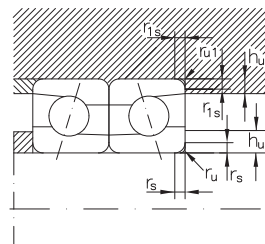
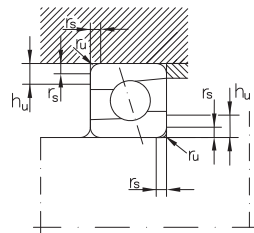



Angular contact ball bearing, single row

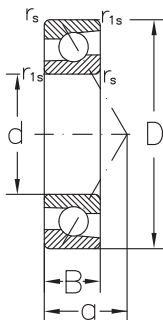

Dimensions					Basic radial load		Speed limit		Designation	Mass	
d	D	B	r <sub>s</sub> min.	r <sub>1s</sub> min.	a	dyn. C <sub>r</sub>	stat. C <sub>0r</sub>	grease			oil
mm					kN		min <sup>-1</sup>		-	Kg	
<b>10</b>	30	9	0,6	0,3	13	4,95	2,5	19000	28000	<b>7200B</b>	0,031
<b>12</b>	32	10	0,6	0,3	14	7,4	3,75	17000	24000	<b>7201B</b>	0,045
<b>15</b>	35	11	0,6	0,3	16	7,45	3,9	16000	22000	<b>7202B</b>	0,048
	35	11	0,6	0,3	16	7,45	3,9	16000	22000	<b>7202BP6</b>	0,048
	35	11	0,6	0,3	16	7,45	3,9	16000	22000	<b>7202BP5</b>	0,048
<b>17</b>	42	13	1	0,6	19	12,9	6,5	14000	19000	<b>7302B</b>	0,090
	40	12	0,6	0,6	18	11	6,1	14000	19000	<b>7203B</b>	0,070
	40	12	0,6	0,6	18	11	6,1	14000	19000	<b>7203BP6</b>	0,070
	40	12	0,6	0,6	18	11	6,1	14000	19000	<b>7203BP5</b>	0,070
	40	12	0,6	0,6	18	11	6,1	14000	19000	<b>7203 BTN</b>	0,064
<b>20</b>	47	14	1	0,6	21	14,8	8,1	12000	17000	<b>7303B</b>	0,120
	47	14	1	0,6	21	14,1	8,4	11000	16000	<b>7204B</b>	0,110
	47	14	1	0,6	21	14,1	8,4	11000	16000	<b>7204BP6</b>	0,110
	47	14	1	0,6	21	14,1	8,4	11000	16000	<b>7204BP5</b>	0,110
	52	15	1,1	0,6	23	17,3	9,7	10000	15000	<b>7304B</b>	0,150
	52	15	1,1	0,6	23	17,3	9,7	10000	15000	<b>7304BP6</b>	0,150
<b>25</b>	52	15	1,1	0,6	23	17,3	9,7	10000	15000	<b>7304 BEP</b>	0,15
	52	15	1	0,6	24	15,5	10,1	9500	14000	<b>7205B</b>	0,130
	52	15	1	0,6	24	15,5	10,1	9500	14000	<b>7205BP6</b>	0,130
	52	15	1	0,6	24	15,5	10,1	9500	14000	<b>7205BP5</b>	0,130
	62	17	1,1	0,6	27	24,4	14,6	8500	12000	<b>7305B</b>	0,250
	62	17	1,1	0,6	27	24,4	14,6	8500	12000	<b>7305BP6</b>	0,250
	62	17	1,1	0,6	27	24,4	14,6	8500	12000	<b>7305AMA</b>	0,250
<b>30</b>	62	17	1,1	0,6	27	24,4	14,6	8500	12000	<b>7305 BEP</b>	0,25
	62	16	1	0,6	27	20,5	13,6	8500	12000	<b>7206B</b>	0,210
	62	16	1	0,6	27	20,5	13,6	8500	12000	<b>7206BP6</b>	0,210
	62	16	1	0,6	27	20,5	13,6	8500	12000	<b>7206BP5</b>	0,210
	62	16	1	0,6	27	20,5	13,6	8500	12000	<b>7206ATAP2</b>	0,210
	72	19	1,1	0,6	31	29,3	19	7500	10000	<b>7306B</b>	0,370
	72	19	1,1	0,6	31	29,3	19	7500	10000	<b>7306BP6</b>	0,370
	72	19	1,1	0,6	31	29,3	19	7500	10000	<b>7306BP5</b>	0,370
	72	19	1,1	0,6	31	29,3	19	7500	10000	<b>7306AMA</b>	0,370
<b>35</b>	72	19	1,1	0,6	31	29,3	19	7500	10000	<b>7306 BEP</b>	0,37
	72	19	1,1	0,6	31	29,3	19	7500	10000	<b>7306 BTN</b>	0,341
	72	17	1,1	0,6	31	28,5	19,8	7500	10000	<b>7207B</b>	0,300
	72	17	1,1	0,6	31	28,5	19,8	7500	10000	<b>7207BP5</b>	0,300
	72	17	1,1	0,6	31	28,5	19,8	7500	10000	<b>7207 BTN</b>	0,282
	80	21	1,5	1	35	36,7	24,3	7000	9500	<b>7307B</b>	0,510
<b>40</b>	80	21	1,5	1	35	36,7	24,3	7000	9500	<b>7307BP5</b>	0,510
	80	18	1,1	0,6	34	32,1	23	6700	9000	<b>7208B</b>	0,390
	80	18	1,1	0,6	34	32,1	23	6700	9000	<b>7208BP6</b>	0,390
	80	18	1,1	0,6	34	32,1	23	6700	9000	<b>7208BP5</b>	0,390

## Angular contact ball bearing, single row

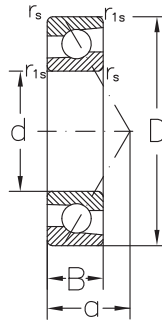

Dimensions						Basic radial load		Speed limit		Designation	Mass
d	D	B	r <sub>s</sub> min.	r <sub>1s</sub> min.	a	dyn. C <sub>r</sub>	stat. C <sub>0r</sub>	grease	oil		
mm						kN		min <sup>-1</sup>		-	Kg
40	90	23	1,5	1	39	44,8	30,3	6300	8500	<b>7308B</b>	0,670
	90	23	1,5	1	39	44,8	30,3	6300	8500	<b>7308 BEP</b>	0,67
	90	23	1,5	1	39	44,8	30,3	6300	8500	<b>7308BP6</b>	0,670
	90	23	1,5	1	39	44,8	30,3	6300	8500	<b>7308BP5</b>	0,670
45	85	19	1,1	0,6	37	36,1	26,2	6300	8500	<b>7209B</b>	0,440
	85	19	1,1	0,6	37	36,1	26,2	6300	8500	<b>7209BP5</b>	0,440
	100	25	1,1	0,6	37	36,1	26,2	6300	8500	<b>7309 BTN</b>	0,813
	100	25	1,5	1	43	58,3	40,1	5600	7500	<b>7309B</b>	0,900
	100	25	1,1	0,6	37	36,1	26,2	6300	8500	<b>7309 BEP</b>	0,900
	100	25	1,5	1	43	58,3	40,1	5600	7500	<b>7309BP6</b>	0,900
50	100	25	1,5	1	43	58,3	40,1	5600	7500	<b>7309BP5</b>	0,900
	90	20	1,1	0,6	39	37,4	28,6	5600	7500	<b>7210B</b>	0,490
	90	20	1,1	0,6	39	37,4	28,6	5600	7500	<b>7210BP6</b>	0,490
	90	20	1,1	0,6	39	37,4	28,6	5600	7500	<b>7210BP5</b>	0,490
	110	27	1,1	0,6	39	37,4	28,6	5600	7500	<b>7310 BTN</b>	1,05
	110	27	1,1	0,6	39	37,4	28,6	5600	7500	<b>7310 BEP</b>	1,15
	110	27	2	1	47	68,2	47,9	5000	6700	<b>7310B</b>	1,15
	110	27	2	1	47	68,2	47,9	5000	6700	<b>7310BP6</b>	1,15
55	110	27	2	1	47	68,2	47,9	5000	6700	<b>7310BP5</b>	1,15
	100	21	1,5	1	43	46,2	36,2	5300	7000	<b>7211B</b>	0,650
	100	21	1,5	1	43	46,2	36,2	5300	7000	<b>7211 AA</b>	0,64
	120	29	2	1	52	78,8	56,4	4500	6000	<b>7311B</b>	1,45
	120	29	2	1	52	78,8	56,4	4500	6000	<b>7311 BTN</b>	1,38
60	120	29	2	1	52	78,8	56,4	4500	6000	<b>7311 BCBY</b>	1,441
	110	22	1,5	1	47	56,3	44,7	4800	6300	<b>7212B</b>	0,840
	110	22	1,5	1	47	56,3	44,7	4800	6300	<b>7212BP5</b>	0,840
	110	22	1,5	1	47	56,3	44,7	4800	6300	<b>7212 BTN</b>	0,777
	130	31	2,1	1,1	56	90	65,5	4300	5600	<b>7312B</b>	1,85
	130	31	2,1	1,1	56	90	65,5	4300	5600	<b>7312BP5</b>	1,85
	130	31	2,1	1,1	56	90	65,5	4300	5600	<b>7312 BECBP</b>	1,85
65	130	31	2,1	1,1	56	90	65,5	4300	5600	<b>7312 BTN</b>	1,71
	120	23	1,5	1	50	63,6	52,5	4300	5600	<b>7213B</b>	1,05
	120	23	1,5	1	50	63,6	52,5	4300	5600	<b>7213BP6</b>	1,05
	120	23	1,5	1	50	63,6	52,5	4300	5600	<b>7213BP5</b>	1,05
	140	33	1,5	1	50	63,6	52,5	4300	5600	<b>7313 BTN</b>	2,12
	140	33	2,1	1,1	60	101	75,3	4000	5300	<b>7313B</b>	2,25
70	125	24	1,5	1	53	69,1	57,8	4300	5600	<b>7214B</b>	1,15
	125	24	1,5	1	53	69,1	57,8	4300	5600	<b>7214 BTN</b>	1,08
	150	35	2,1	1,1	64	114	86	3800	5000	<b>7314B</b>	2,75
	150	35	2,1	1,1	64	114	86	3800	5000	<b>7314 BEP</b>	2,75
	150	35	2,1	1,1	64	114	86	3800	5000	<b>7314BP6</b>	2,75
	150	35	2,1	1,1	64	114	86	3800	5000	<b>7314BP5</b>	2,75



Angular contact ball bearing, single row

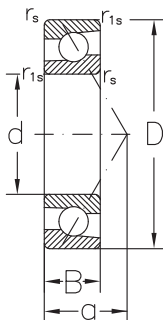

d	D	Dimensions				Basic radial load			Speed limit		Designation	Mass
		B	r <sub>s</sub> min.	r <sub>1s</sub> min.	a	dyn. C <sub>r</sub>	stat. C <sub>0r</sub>	grease	oil			
mm						kN			min <sup>-1</sup>		-	Kg
<b>70</b>	150	35	2,1	1,1	64	114	86	3800	5000	<b>7314BTN</b>	2,75	
	130	25	1,5	1	56	74,8	63,2	4000	5300	<b>7215B</b>	1,30	
<b>75</b>	130	25	1,5	1	56	74,8	63,2	4000	5300	<b>7215BP6</b>	1,30	
	130	25	1,5	1	56	74,8	63,2	4000	5300	<b>7215BP5</b>	1,30	
	130	25	1,5	1	56	74,8	63,2	4000	5300	<b>7215 BTN</b>	1,16	
	160	37	2,1	1,1	68	125	97,5	3400	4500	<b>7315B</b>	3,30	
	160	37	2,1	1,1	68	125	97,3	3400	4500	<b>7315BMAP6</b>	3,30	
	160	37	2,1	1,1	68	125	97,5	3400	4500	<b>7315AMA</b>	3,30	
	160	37	2,1	1,1	68	125	97,5	3400	4500	<b>7315 BEGAM</b>	3,30	
	160	37	2,1	1,1	68	125	97,5	3400	4500	<b>7315 BTN</b>	3,1	
<b>80</b>	140	26	2	1	59	80,5	69,3	3800	5000	<b>7216B</b>	1,55	
	140	26	2	1	59	80,5	69,3	3800	5000	<b>7216 BTN</b>	1,42	
	170	39	2,1	1,1	72	135	109	3200	4300	<b>7316B</b>	3,90	
	170	39	2,1	1,1	72	135	109	3200	4300	<b>7316 BTN</b>	3,66	
	170	39	2,1	1,1	72	135	109	3200	4300	<b>7316BP6</b>	3,903	
<b>85</b>	170	39	2,1	1,1	72	135	109	3200	4300	<b>7316BMAP6</b>	3,903	
	150	28	2	1	64	93,1	81,1	3400	4500	<b>7217B</b>	1,953	
	180	41	3	1,1	76	145	122	3000	4000	<b>7317B</b>	4,603	
	180	41	3	1,1	76	145	122	3000	4000	<b>7317BP6</b>	4,603	
	180	41	3	1,1	76	145	122	3000	4000	<b>7317BMP6</b>	4,603	
<b>90</b>	160	30	2	1	67	107	93,8	3200	4300	<b>7218B</b>	2,403	
	160	30	2	1	67	107	93,8	3200	4300	<b>7218BMB</b>	2,403	
	160	30	2	1	67	107	93,8	3200	4300	<b>7218 BTN</b>	2,21	
	190	43	3	1,1	80	156	135	2800	3800	<b>7318B</b>	5,403	
<b>95</b>	190	43	3	1,1	80	156	135	2800	3800	<b>7318 BTN</b>	5	
	170	32	2,1	1,1	71	116	101	3000	4000	<b>7219B</b>	2,903	
	170	32	2,1	1,1	71	116	101	3000	4000	<b>7219 BTN</b>	2,64	
	200	45	3	1,1	84	168	150	2600	3600	<b>7319B</b>	6,253	
<b>100</b>	180	34	2,1	1,1	76	129	116	2800	3800	<b>7220B</b>	3,453	
	180	34	2,1	1,1	76	129	116	2800	3800	<b>7220BP6</b>	3,453	
	180	34	2,1	1,1	76	129	116	2800	3800	<b>7220BMA</b>	3,453	
	180	34	2,1	1,1	76	129	116	2800	3800	<b>7220BMAP6</b>	3,453	
	180	34	2,1	1,1	76	129	116	2800	3800	<b>7220BMAP4</b>	3,453	
	180	34	2,1	1,1	76	129	116	2800	3800	<b>7220BMB</b>	3,453	
	180	34	2,1	1,1	76	129	116	2800	3800	<b>7220 BM</b>	3,6	
	215	47	3	1,1	90	190	178	2400	3400	<b>7320B</b>	7,753	
	215	47	3	1,1	90	190	178	2400	3400	<b>7320BP6</b>	7,753	
	215	47	3	1,1	90	190	178	2400	3400	<b>7320 M</b>	7,75	
<b>110</b>	215	47	3	1,1	90	190	178	2400	3400	<b>7320BM</b>	7,753	
	200	38	2,1	1,1	84	153	145	2400	3400	<b>7222B</b>	4,803	
	200	38	2,1	1,1	84	153	145	2400	3400	<b>7222BMB</b>	4,803	
	240	50	3	1,1	99	248	229	2000	3000	<b>7322B</b>	10,53	

### Angular contact ball bearing, single row

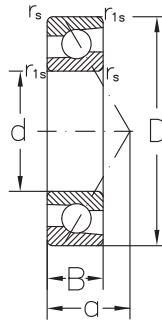

Dimensions						Basic radial load		Speed limit		Designation	Mass
d	D	B	r <sub>s</sub> min.	r <sub>1s</sub> min.	a	dyn. C <sub>r</sub>	stat. C <sub>0r</sub>	grease	oil		
mm						kN		min <sup>-1</sup>		-	Kg
<b>110</b>	240	50	3	1,1	99	248	229	2000	3000	<b>7322BP5</b>	10,53
	240	50	3	1,1	99	248	229	2000	3000	<b>7322BM</b>	10,53
<b>140</b>	250	42	3	1,1	103	191	210	1700	2400	<b>7228B</b>	8,803
	300	62	4	1,5	123	290	334	1700	2400	<b>7328B</b>	21,63
	300	62	4	1,5	123	290	334	1700	2400	<b>7328BMBP5</b>	21,63
<b>150</b>	190	24	1,1	0,6	35	60,5	79,2	2200	3000	<b>72830CMA</b>	3,363
	270	45	3	1,1	111	195	222	2000	2800	<b>7230BM</b>	11,63
	320	65	4	1,5	131	317	380	1600	2000	<b>7330BM</b>	26,53
	320	65	4	1,5	131	317	380	1600	2000	<b>7330 M</b>	26,53
	320	65	4	1,5	131	317	380	1600	2000	<b>7330BMP5</b>	26,53
<b>160</b>	220	28	2	1	58	110	134	2200	3000	<b>71932AMAP5</b>	3,263
<b>180</b>	250	33	2	2	33	131	162	2000	2800	<b>71936AM</b>	5,36
<b>200</b>	250	30	1,5	0,6	45	102	141	3000	5600	<b>72840CMAF4</b>	3,43



**Angular contact ball bearing, single row, for paired and stack mounted**

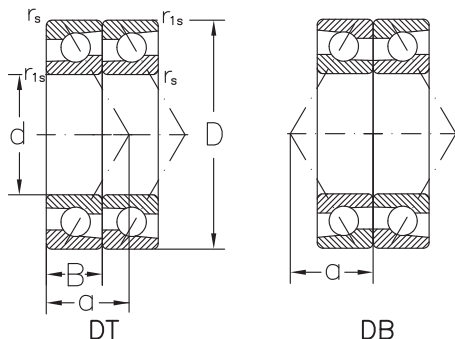

Dimensions						Basic radial load		Speed limit		Designation	Mass
d	D	B	r <sub>s</sub> min.	r <sub>1s</sub> min.	a	dyn. C <sub>r</sub>	stat. C <sub>0r</sub>	grease	oil		
mm						kN		min <sup>-1</sup>		-	Kg
15	35	11	0,6	0,3	16	12	7,8	14000	20000	<b>7202BDT</b>	0,096
	35	11	0,6	0,3	16	12	7,8	13000	18000	<b>7202BDB</b>	0,096
	35	11	0,6	0,3	16	12	7,8	14000	20000	<b>7202BP6DT</b>	0,096
	35	11	0,6	0,3	16	12	7,8	13000	18000	<b>7202BP5DB</b>	0,096
17	40	12	0,6	0,6	18	17,8	12,2	13000	17000	<b>7203BDT</b>	0,140
	40	12	0,6	0,6	18	17,8	12,2	11000	15000	<b>7203BDB</b>	0,140
	40	12	0,6	0,6	18	17,8	12,2	11000	15000	<b>7203BDF</b>	0,140
	40	12	0,6	0,6	18	17,8	12,2	11000	15000	<b>7203BP6DB</b>	0,140
20	40	12	0,6	0,6	18	17,8	12,2	11000	15000	<b>7203BP5DB</b>	0,140
	47	14	1	0,6	21	24	16,2	11000	15000	<b>7303BDT</b>	0,240
	47	14	1	0,6	21	22,8	16,8	10000	14000	<b>7204BDT</b>	0,220
	47	14	1	0,6	21	22,8	16,8	10000	14000	<b>7204BDB</b>	0,220
	47	14	1	0,6	21	22,8	16,8	9000	13000	<b>7204BDF</b>	0,220
	47	14	1	0,6	21	22,8	16,8	9000	13000	<b>7204BP6DB</b>	0,220
25	52	15	1,1	0,6	23	28	19,4	9000	14000	<b>7304BDT</b>	0,303
	52	15	1,1	0,6	23	28	19,4	8000	12000	<b>7304BDB</b>	0,303
	52	15	1,1	0,6	23	28	19,4	8000	12000	<b>7304BDF</b>	0,303
	52	15	1	0,6	24	25,1	20,2	9000	13000	<b>7205BDT</b>	0,260
	52	15	1	0,6	24	25,1	20,2	9000	13000	<b>7205BP5DT</b>	0,260
	52	15	1	0,6	24	25,1	20,2	7500	11000	<b>7205BDB</b>	0,260
	52	15	1	0,6	24	25,1	20,2	7500	11000	<b>7205BDF</b>	0,260
	52	15	1	0,6	24	25,1	20,2	7500	11000	<b>7205BP6DB</b>	0,260
	52	15	1	0,6	24	25,1	20,2	7500	11000	<b>7205BP5DB</b>	0,260
	52	15	1	0,6	24	33,5	30,3	7000	10000	<b>7205BP5TFT</b>	0,390
30	62	17	1,1	0,6	27	39,5	29,2	7500	11000	<b>7305BDT</b>	0,500
	62	17	1,1	0,6	27	39,5	29,2	6700	9500	<b>7305BDB</b>	0,500
	62	17	1,1	0,6	27	39,5	29,2	6700	9500	<b>7305BDF</b>	0,500
	62	17	1,1	0,6	27	39,5	29,2	6700	9500	<b>7305AMADF</b>	0,500
	62	16	1	0,6	27	33,2	27,2	7500	11000	<b>7206BDT</b>	0,420
	62	16	1	0,6	27	33,2	27,2	7500	11000	<b>7206ATAP2DT</b>	0,420
	62	16	1	0,6	27	33,2	27,2	6700	9500	<b>7206BDB</b>	0,420
	62	16	1	0,6	27	33,2	27,2	6700	9500	<b>7206BDF</b>	0,420
	62	16	1	0,6	27	33,2	27,2	6700	9500	<b>7206BP6DB</b>	0,420
	62	16	1	0,6	27	33,2	27,2	6700	9500	<b>7206BP5DB</b>	0,420
30	62	16	1	0,6	27	33,2	27,2	6700	9500	<b>7206BP5DF</b>	0,420
	62	16	1	0,6	27	44,3	40,8	6000	8500	<b>7206BP5TFT</b>	0,630
	72	19	1,1	0,6	31	47,5	38	6700	9000	<b>7306BDT</b>	0,740
	72	19	1,1	0,6	31	47,5	38	6000	8000	<b>7306BDB</b>	0,740
	72	19	1,1	0,6	31	47,5	38	6000	8000	<b>7306BDF</b>	0,740
	72	19	1,1	0,6	31	63,3	57	5300	7000	<b>7306BTFT</b>	1,113
	72	19	1,1	0,6	31	77,4	76	5300	7000	<b>7306BQFC</b>	1,483



## Angular contact ball bearing, single row, for paired and stack mounted

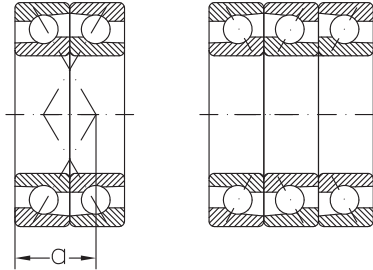

DF

TFT

d	Dimensions					Basic radial load		Speed limit		Designation	Mass
	D	B	r <sub>s</sub> min.	r <sub>is</sub> min.	a	dyn. C <sub>r</sub>	stat. C <sub>0r</sub>	grease	oil		
mm						kN		min <sup>-1</sup>		-	Kg
30	72	19	1,1	0,6	31	47,5	38	6700	9000	<b>7306BP5DT</b>	0,740
	72	19	1,1	0,6	31	47,5	38	6700	9000	<b>7306AMADT</b>	0,740
35	72	19	1,1	0,6	31	47,5	38	6700	8000	<b>7306AMADF</b>	0,740
	72	17	1,1	0,6	31	46,2	39,6	6700	9000	<b>7207BDT</b>	0,600
	72	17	1,1	0,6	31	46,2	39,6	6700	9000	<b>7207BP5DT</b>	0,600
	72	17	1,1	0,6	31	46,2	39,6	6000	8000	<b>7207BDB</b>	0,600
	72	17	1,1	0,6	31	46,2	39,6	6000	8000	<b>7207BDF</b>	0,600
	72	17	1,1	0,6	31	46,2	39,6	6000	8000	<b>7207BP5DB</b>	0,600
	72	17	1,1	0,6	31	61,6	59,4	5300	7000	<b>7207BP5TBT</b>	0,900
	72	17	1,1	0,6	31	75,2	79,2	5300	7000	<b>7207BP5QFC</b>	1,203
	80	21	1,5	1	35	59,5	48,6	6300	8500	<b>7307BDT</b>	1,023
	80	21	1,5	1	35	59,5	48,6	5600	7500	<b>7307BDB</b>	1,023
	80	21	1,5	1	35	59,5	48,6	5600	7500	<b>7307BDF</b>	1,023
	80	21	1,5	1	35	59,5	48,6	5600	7500	<b>7307BP6DB</b>	1,023
40	80	18	1,1	0,6	34	52	46	6030	8100	<b>7208BDB</b>	0,780
	80	18	1,1	0,6	34	52	46	6000	8000	<b>7208BDT</b>	0,780
	80	18	1,1	0,6	34	52	46	6000	8000	<b>7208BP5DT</b>	0,780
	80	18	1,1	0,6	34	52	46	5300	7000	<b>7208BDF</b>	0,780
	80	18	1,1	0,6	34	52	46	5300	7000	<b>7208BP5DB</b>	0,780
	90	23	1,5	1	39	72,6	60,6	5600	7500	<b>7308BDT</b>	1,343
	90	23	1,5	1	39	72,6	60,6	5000	6700	<b>7308BDB</b>	1,343
	90	23	1,5	1	39	72,6	60,6	5000	6700	<b>7308BDF</b>	1,343
	90	23	1,5	1	39	72,6	60,6	5000	6700	<b>7308BP6DF</b>	1,343
	90	23	1,5	1	39	72,6	60,6	5000	6700	<b>7308BP5DB</b>	1,343
	90	23	1,5	1	39	96,8	91,8	4500	6000	<b>7308BTFT</b>	0,670
	90	23	1,5	1	39	96,8	91,8	4500	6000	<b>7308BP5TFT</b>	2,013
90	23	1,5	1	39	118	121	4500	6000	<b>7308BQFC</b>	2,683	
90	23	1,5	1	39	118	121	4500	6000	<b>7308BP5QFC</b>	2,683	
45	85	19	1,1	0,6	37	58,5	52,4	5600	7500	<b>7209BDT</b>	0,880
	85	19	1,1	0,6	37	58,5	52,4	5000	6700	<b>7209BDB</b>	0,880
	85	19	1,1	0,6	37	58,5	52,4	5000	6700	<b>7209BDF</b>	0,880
	85	19	1,1	0,6	37	58,5	52,4	5000	6700	<b>7209BP5DB</b>	0,880
	100	25	1,5	1	43	94,4	80,2	5000	6700	<b>7309BDT</b>	1,803
	100	25	1,5	1	43	94,4	80,2	4500	6000	<b>7309BDB</b>	1,803
	100	25	1,5	1	43	94,4	80,2	4480	6000	<b>7309BDF</b>	1,803
	100	25	1,5	1	43	94,4	80,2	4500	6000	<b>7309BP6DB</b>	1,803
50	100	25	1,5	1	43	94,4	80,2	4500	6000	<b>7309BP6DF</b>	1,803
	90	20	1,1	0,6	39	60,6	57,2	5000	6700	<b>7210BDT</b>	0,980
	90	20	1,1	0,6	39	60,6	57,2	5000	6700	<b>7210BP5DT</b>	0,980
	90	20	1,1	0,6	39	60,6	57,2	4500	6000	<b>7210BDF</b>	0,980
	90	20	1,1	0,6	39	60,6	57,2	4500	6000	<b>7210BP5DB</b>	0,980
110	27	2	1	47	111	95,8	4000	5300	<b>7310BDB</b>	2,303	



Angular contact ball bearing, single row, for paired and stack mounted

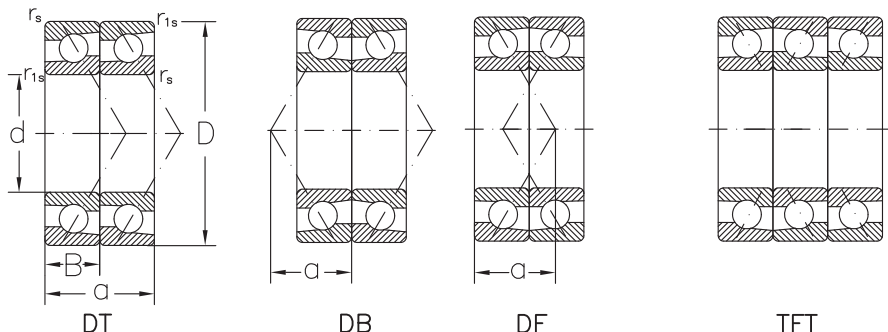

d	Dimensions					Basic radial load		Speed limit		Designation	Mass
	D	B	r <sub>s</sub> min.	r <sub>1s</sub> min.	a	dyn. C <sub>r</sub>	stat. C <sub>0r</sub>	grease	oil		
mm											
						kN		min <sup>-1</sup>		-	
50	110	27	2	1	47	111	95,8	4000	5300	7310BDF	2.303
	110	27	2	1	47	205	144	3600	4800	7310BP5TFT	3.453
	110	27	2	1	47	273	192	3600	4800	7310BP5QFC	4.603
55	100	21	1,5	1	43	74,8	72,4	4800	6300	7211BDT	1.303
	100	21	1,5	1	43	74,8	72,4	4300	5600	7211BDB	1.303
	100	21	1,5	1	43	74,8	72,4	4300	5600	7211BDF	1.303
	120	29	2	1	51	128	113	4000	5300	7311BDT	2.903
	120	29	2	1	51	128	113	3600	4800	7311BDB	2.903
	120	29	2	1	52	128	113	3600	4800	7311BDF	2.903
60	110	22	1,5	1	47	91,2	89,4	4300	5600	7212BDT	1.683
	110	22	1,5	1	47	91,2	89,4	3800	5000	7212BDB	1.683
	110	22	1,5	1	47	91,2	89,4	3800	5000	7212BDF	1.683
	110	22	1,5	1	47	91,2	89,4	3800	5000	7212BP5DB	1.683
	130	31	2,1	1,1	55	146	131	3800	5000	7312BDT	3.703
	130	31	2,1	1,1	55	146	131	3400	4500	7312BDB	3.703
	130	31	2,1	1,1	55	146	131	3400	4500	7312BDF	3.703
65	120	23	1,5	1	50	103	105	3800	5000	7213BDT	2.103
	120	23	1,5	1,1	50	103	105	3800	5000	7213BDB	2.103
	120	23	1,5	1,1	50	103	105	3800	5000	7213BDF	2.103
	120	23	1,5	1	50	103	105	3400	4500	7213BP6DB	2.103
	140	33	2,1	1,1	60	164	151	3600	4800	7313BDT	4.503
	140	33	2,1	1,1	60	164	151	3200	4300	7313BDB	4.503
	140	33	2,1	1,1	60	164	151	3200	4300	7313BDF	4.503
	140	33	2,1	1,1	60	164	151	3200	4300	7313BP5DB	4.503
70	125	24	1,5	1	53	112	116	3800	5000	7214BDT	2.303
	125	24	1,5	1	53	112	116	3400	4500	7214BDB	2.303
	125	24	1,5	1	53	112	116	3400	4500	7214BDF	2.303
	150	35	2,1	1,1	64	185	172	3400	4500	7314BDT	5.503
	150	35	2,1	1,1	64	185	172	3400	4500	7314BP6DT	5.503
	150	35	2,1	1,1	64	185	172	3400	4500	7314BP5DT	5.503
	150	35	2,1	1,1	64	185	172	3000	4000	7314BDB	5.503
	150	35	2,1	1,1	64	185	172	3000	4000	7314BDF	5.503
75	130	25	1,5	1	56	121	126	3600	4300	7215BDT	2.603
	130	25	1,5	1	56	121	126	3200	4300	7215BDB	2.603
	130	25	1,5	1	56	121	126	3200	4300	7215BDF	2.603
	130	25	1,5	1	56	121	126	3200	4300	7215BP6DB	2.603
	160	37	2,1	1,1	68	203	195	3200	4000	7315BDT	6.603
	160	37	2,1	1,1	68	203	195	2800	3600	7315BDB	6.603
	160	37	2,1	1,1	68	203	195	2800	3600	7315BDF	6.603
	160	37	2,1	1,1	68	203	195	2800	3600	7315BP6DB	6.603



### Angular contact ball bearing, single row, for paired and stack mounted

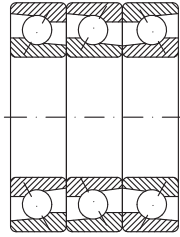

TBT

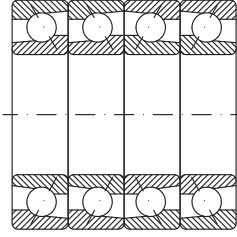

QFC

d	Dimensions					Basic radial load		Speed limit		Designation	Mass
	D	B	r <sub>s</sub> min.	r <sub>1s</sub> min.	a	dyn. C <sub>r</sub>	stat. C <sub>0r</sub>	grease	oil		
mm						kN		min <sup>-1</sup>		-	Kg
75	160	37	2,1	1,1	68	203	195	2800	3600	7315AMADF	6.603
	110	16	1	1	21	55,1	69,2	4000	5300	71916CTAP4DT	0,736
80	140	26	2	1	59	130	139	3200	4300	7216BDT	3.103
	140	26	2	1	59	130	139	2800	3800	7216BDB	3.103
	140	26	2	1	59	130	139	2800	3800	7216BDF	3.103
	170	39	2,1	1,1	72	219	218	2800	3800	7316BDT	7.803
	170	39	2,1	1,1	72	219	218	2800	3800	7316BP6DT	7.803
	170	39	2,1	1,1	72	219	218	2600	3400	7316BDB	7.803
	170	39	2,1	1,1	72	219	218	2600	3400	7316BDF	7.803
	170	39	2,1	1,1	72	292	327	2200	3000	7316BTBT	11,73
	170	39	2,1	1,1	72	292	327	2200	3000	7316BMAP6TBT	11,73
85	150	28	2	1	64	151	162	3000	4000	7217BDT	3.903
	150	28	2	1	64	151	162	2800	3600	7217BDB	3.903
	150	28	2	1	64	151	162	2800	3600	7217BDF	3.903
	180	41	3	1,1	76	235	244	2800	3600	7317BDB	9.203
	180	41	3	1,1	76	235	244	2400	3200	7317BDF	9.203
	180	41	3	1,1	76	235	244	2800	3800	7218BDT	4.803
90	160	30	2	1	67	173	188	2600	3400	7218BDB	4.803
	160	30	2	1	67	173	188	2600	3400	7218BDF	4.803
	190	43	3	1,1	80	253	270	2600	3400	7318BDT	10,83
	190	43	3	1,1	80	253	270	2200	3000	7318BDB	10,83
	190	43	3	1,1	80	253	270	2200	3000	7318BDF	10,83
	190	43	3	1,1	80	337	405	2000	2600	7318BTBT	16,23
95	170	32	2,1	1,1	72	188	202	2800	3600	7219BDT	5.803
	170	32	2,1	1,1	72	188	202	2400	3200	7219BDB	5.803
	170	32	2,1	1,1	72	188	202	2400	3200	7219BDF	5.803
	200	45	3	1,1	84	272	300	2400	3200	7319BDT	12,53
	200	45	3	1,1	84	272	300	2000	2800	7319BDB	12,53
100	200	45	3	1,1	84	272	300	2000	2800	7319BDF	12,53
	180	34	2,1	1,1	76	208	232	2600	3400	7220BDT	6.903
	180	34	2,1	1,1	76	208	232	2200	3000	7220BDB	6.903
	180	34	2,1	1,1	76	208	232	2200	3000	7220BDF	6.903
	180	34	2,1	1,1	76	208	232	2200	3000	7220BMADB	6.903
	180	34	2,1	1,1	76	208	232	2200	3000	7220BMAP6DB	6.903
	180	34	2,1	1,1	76	208	232	2600	2800	7220BMAP4DT	6.903
	215	47	3	1,1	90	308	356	1900	2800	7320BDB	15,53
	215	47	3	1,1	90	308	356	1900	2800	7320BDF	15,53
	215	47	3	1,1	90	308	356	2200	3000	7320BDT	15,53
	215	47	3	1,1	90	308	356	2200	3000	7320BP6DT	15,53
110	215	47	3	1,1	90	308	356	2200	3000	7320BMDT	15,53
	200	38	2,1	1,1	84	248	290	2200	3000	7222BDT	9.603



**Angular contact ball bearing, single row, for paired and stack mounted**

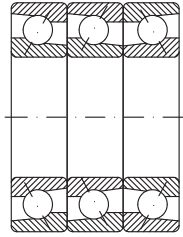

TBT

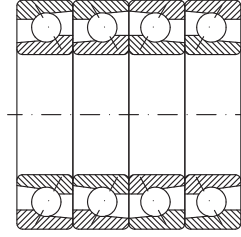

QFC

d	Dimensions					Basic radial load		Speed limit		Designation	Mass
	D	B	r <sub>s</sub> min.	r <sub>1s</sub> min.	a	dyn. C <sub>r</sub>	stat. C <sub>0r</sub>	grease	oil		
	mm					kN		min <sup>-1</sup>		-	Kg
110	200	38	2,1	1,1	84	248	290	1900	2800	<b>7222BDB</b>	9,603
	240	50	3	1,1	99	365	458	1800	2800	<b>7322BDT</b>	21,03
	240	50	3	1,1	99	365	458	1800	2800	<b>7322BP5DT</b>	21,03
	240	50	3	1,1	99	365	458	1600	2400	<b>7322BMD</b>	21,03
	240	50	3	1,1	99	365	458	1600	2400	<b>7322BDB</b>	21,03
140	240	50	3	1,1	99	536	687	1400	2200	<b>7322BTBT</b>	31,53
	250	42	3	1,1	103	172	189	1400	1900	<b>7228BDT</b>	17,63
	300	62	4	1,5	123	470	668	1400	2200	<b>7328BDT</b>	43,23
	300	62	4	1,5	123	470	668	1400	2200	<b>7328BMBP5DT</b>	43,23
	300	62	4	1,5	123	470	668	1200	1900	<b>7328BDB</b>	43,23
150	270	45	3	1,1	111	156	444	2400	3800	<b>7230BDB</b>	23,23
	270	45	3	1,1	111	156	444	2400	3800	<b>7230BMD</b>	23,23
	320	65	4	1,5	131	254	760	1400	1800	<b>7330BMD</b>	53,03
	320	65	4	1,5	131	254	760	1400	1800	<b>7330BMP5DT</b>	53,03
160	220	28	2	1	58	176	268	1600	2400	<b>71932AMAP5DB</b>	6,523
180	250	33	2	2	33	210	324	1500	2200	<b>71936AMDB</b>	10,83
200	250	30	1,5	0,6	45	165	282	1400	2000	<b>72840CMAP4DB</b>	6,863
	250	30	1,5	0,6	45	220	423	1300	1800	<b>72840CMAP4TBT</b>	10,23

**URB**





# Cylindrical roller bearings

Cylindrical roller bearings are manufactured in a various range of constructive types and sizes, particularly single row cylindrical roller bearings but also two or more row cylindrical roller bearings, with cages or roller by roller, as shown in the designs below.

In case of cylindrical roller bearings, the rollers are laterally guided by the fixed ribs of one ring.

In case of bearings with cages, the ring with ribs and the rollers retained in the cage can be drawn out from the other ring, which means that these bearings are dismountable.

Therefore, bearings from joints can be much easier mounted and dismounted, especially where interference fits are needed for both rings due to the loading conditions.

Bearings are provided with unloaded rollers at both generatrix ends. Therefore, the linear contact between rollers and rings alters advantageously, i.e. peripheral stresses are avoided.

- single row
- double row
- without cage (full complement)

- single row



NU



NJ



NUP



N



RNJ



NJ+HJ



NU+HJ

- double row

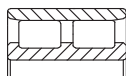

NN30

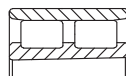

NN30K

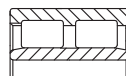

NNU49

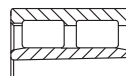

NNU49K

- without cage (full complement)



NCF V



NJ VH

## Suffixes

- AR** - Grinding addition on the inner ring raceway
- B** - Cylindrical roller bearings with extended inner ring
- C2** - Radial clearance smaller than normal, bearings with interchangeable elements
- C2NA** - Radial clearance smaller than normal, bearings with non-interchangeable elements
- C3** - Radial clearance larger than normal, bearings with interchangeable elements
- C3NA** - Radial clearance larger than normal, bearings with non-interchangeable elements

- D** - Two-pieces inner ring
- E** - Cylindrical roller bearings, E-design (increased basic static and dynamic loads)
- F** - Machined steel or special cast iron cage
- F2** - Constructive modification
- K** - Tapered bore bearing
- M** - Machined brass cage guided on the rolling elements
- M6** - Machined brass cage with integral rivets
- MA** - Machined brass cage guided in the outer ring
- MA6** - Machined brass cage with internal rivets guided on the outer ring
- MB** - Machined brass cage guided in the inner ring



- MPA** - Machined brass cage (one-piece)  
**N** - Circular groove in the outer ring for snap ring  
**NA** - Radial clearance, non-interchangeable elements  
**NR** - Circular groove in the outer ring and snap ring  
**P** - Two-pieces outer ring  
**P5** - Tolerance class more accurate than normal (P6)  
**P51** - Tolerance class P5 and radial clearance C1  
**P53** - Tolerance class P5 and radial clearance C3  
**P4** - Tolerance class more accurate than P5  
**P41** - Tolerance class P4 and radial clearance C1  
**R...** - Non-standardized radial clearance (e.g. R45...85)  
**TN** - Polyamide cage  
**V** - Roller bearing without cage (full complement)  
**VH** - Self-retaining roller bearing without cage  
**W20** - Lubrication holes in the outer ring  
**W518** - Lubrication holes in the outer and inner ring  
**W5** - Lubrication groove and holes in both rings  
**W513** - Lubrication groove and holes in the outer ring and lubrication holes in the inner ring  
 $W513 = W33 + W26$   
**W7** - Locating holes  
**W8** - Lubrication groove on the outer ring side surfaces  
**W9** - Lubrication groove on the inner ring side surfaces  
**W20** - Lubrication holes in the outer ring  
**W33** - Lubrication groove and holes on the outer ring  
**W44** - Lubrication groove and holes on the Inner ring  
**W339** - W9 + W33  
**ZS** - NA radial clearance; changing the bearing elements, the clearance can be obtained from the interchangeable elements.

### Single or more rows cylindrical roller bearings

Single or more rows cylindrical roller bearings are manufactured by URB in various constructive versions, depending on the position of the ribs on

rings. The four basic designs (NU, NJ, N and NUP) are given in the bearing tables.

Bearings of NU design have two fixed ribs on the outer ring and one smooth inner ring. Bearings of N design have two fixed ribs on the inner ring and one smooth outer ring. These designs allow an axial displacement in certain limits, of the shaft in relation to the housing. Therefore, these rolling bearings are used in non-locating bearing units.

Bearings of NJ design have two fixed ribs on the outer ring and a fixed rib on the inner ring which can guide the shaft in a single direction (axially).

Bearings of NUP design have also two fixed ribs on the outer ring and, on the inner ring, a fixed rib and a support washer. This way they can be used as locating bearings, guiding the shaft axially in both directions.

For a shaft guiding in a single direction, it also can be used a bearing of NU design which is combined with a support washer. Thus, the constructive version NUJ is obtained.

Support washers on both sides of a bearing of NU design are not allowed as they lead to an axial blocking of the rollers.

Cylindrical roller bearings can carry heavy radial loads and can operate at high speeds.

Double or more rows cylindrical roller bearings have small sections, high load carrying capacity and stiffness.

These bearings provide high stiffness and maximum load carrying capacity and are particularly used for tool holders of the machine- tools and rolling mills.

Double row cylindrical roller bearings series NNU49 and NN30 are generally manufactured to tolerance classes P5 and SP, used for machine tools.

Large-sized bearings series NNU49 are also manufactured to the normal tolerance class.

### Cylindrical roller bearings with snap ring groove

Single row cylindrical roller bearings are also manufactured with snap ring grooves on the outer

rings. This design simplifies the bearing joint as the bearings are located into the housing by means of the snap rings. The snap ring groove and snap rings are in accordance with ISO 464, and tables 7 and 8 on page 90 and 92.

### Cylindrical roller bearings without cage (full complement)

These bearings incorporate the maximum number of rollers and have a small section in relation to their width.

This provides a high load carrying capacity and allows space-saving designs to be achieved.

Cylindrical roller bearings without cage cannot be used at speeds as high as those with cages. These bearings are manufactured with single or more row rollers and suffix V is added to the bearing designation. The most utilized bearings are those of series NCF29 V, NCF30 V and NJ23 VH and they are given in this catalogue on page 210.

### Dimensions

The main dimensions of standardized bearings given in tables are in accordance with ISO15.

### Misalignment

The modified contact between rollers and raceway allows not only peripheral stresses to be avoided but also, in case of single row roller bearings, permits an angular misalignment of the outer ring with respect to the inner ring, depending on the bearing series and load according to the table 1.

Bearings series	Permissible misalignment	
	$P \leq 0,1 C_r$	$P > 0,1 C_r$
<b>NU10, NU2, NU3, NU4, NU2E, NU3E</b>	max. 3'	max. 7'
<b>NU22, NU23, NU22E, NU23E</b>	max. 2'	max. 4'
<b>N,NJ,NUP design, all series</b>	max. 2'	max. 4'

Bore diameter		Clearance group symbol									
d		C2		Normal		C3		C4		C5	
over	up to	min.	max.	min.	max.	min.	max.	min.	max.	min.	max.
mm		$\mu\text{m}$									
	<b>24</b>	0	25	20	45	35	60	50	75	65	90
<b>24</b>	<b>30</b>	0	25	20	45	35	60	50	75	70	95
<b>30</b>	<b>40</b>	5	30	25	50	45	70	60	85	80	105
<b>40</b>	<b>50</b>	5	35	30	60	50	80	70	100	95	125
<b>50</b>	<b>65</b>	10	40	40	70	60	90	80	110	110	140
<b>65</b>	<b>80</b>	10	45	40	75	65	100	90	125	130	165
<b>80</b>	<b>100</b>	15	50	50	85	75	110	105	140	155	190
<b>100</b>	<b>120</b>	15	55	50	90	85	125	125	165	180	220
<b>120</b>	<b>140</b>	15	60	60	105	100	145	145	190	200	245
<b>140</b>	<b>160</b>	20	70	70	120	115	165	165	215	225	275
<b>160</b>	<b>180</b>	25	75	75	125	120	170	170	220	250	300
<b>180</b>	<b>200</b>	35	90	90	145	140	195	195	250	275	330
<b>200</b>	<b>225</b>	45	105	105	165	160	220	220	280	305	365
<b>225</b>	<b>250</b>	45	110	110	175	170	235	235	300	330	395
<b>250</b>	<b>280</b>	55	125	125	195	190	260	260	330	370	440
<b>280</b>	<b>315</b>	55	130	130	205	200	275	275	350	410	485
<b>315</b>	<b>355</b>	65	145	145	225	225	305	305	385	455	535
<b>355</b>	<b>400</b>	100	190	190	280	280	370	370	460	510	600
<b>400</b>	<b>450</b>	110	210	210	310	310	410	410	510	565	665
<b>450</b>	<b>500</b>	110	220	220	330	330	440	440	550	625	735
<b>500</b>	<b>560</b>	120	240	240	360	360	480	480	600	665	780
<b>560</b>	<b>630</b>	140	260	260	380	380	500	500	620	675	795
<b>630</b>	<b>710</b>	145	285	285	425	425	565	565	705	775	845
<b>710</b>	<b>800</b>	150	310	310	470	470	630	630	790	790	950
<b>800</b>	<b>900</b>	180	350	350	520	520	690	690	860	860	1030
<b>900</b>	<b>1000</b>	200	390	390	580	580	770	770	960	960	1150
<b>1000</b>	<b>1120</b>	220	430	430	640	640	850	850	1060	1060	1270
<b>1120</b>	<b>1250</b>	230	470	470	710	710	950	950	1190	1190	1430
<b>1250</b>	<b>1400</b>	270	530	530	790	790	1050	1050	1310	1310	1570
<b>1400</b>	<b>1 600</b>	330	610	610	890	890	1170	1170	1450	1450	1730

<sup>1)</sup> Radial clearance for bearings with tapered bore is staggered with one group to the right, for example radial clearance C3 for cylindrical bore bearing match Normal radial clearance for tapered bore bearings.



## Tolerances and radial clearance

Single row cylindrical roller bearings are usually manufactured to normal tolerance class with normal radial clearance. They can also be manufactured to more accurate tolerance classes and with larger (C3NA and C4NA) or smaller (C1NA and C2NA) radial clearances.

Tolerances of cylindrical roller bearings are given on pages 28.

Radial clearances according to international standard ISO 5753 are given in tables 2 and 3 for cylindrical bore bearings both with interchangeable rings and with non-interchangeable rings (NA).

## Cages

Small and medium-sized single row cylindrical roller bearings are generally fitted with pressed sheet cages. Large-sized bearings are fitted with machined brass cages of normal design, i.e. cages of separable design guided on rolling elements M, on the outside surface MA or inner surface MB. In case of heavy loads and high speeds, cages are made in one piece.

Glass fiber reinforced polyamide 6.6 cages, are successfully used for small and medium-sized bearings, if the operating temperature doesn't exceed + 120°C. These cages have low mass, low coefficient of friction and are noiseless while running.

Cage design and some technical data are given in table 4.

Radial clearance for single and double row cylindrical roller bearings													
Bore diameter		Clearance group symbol											
d		C1NA		C2NA		NA		C3NA		C4NA		C5NA	
over	up to	min.	max.	min.	max.	min.	max.	min.	max.	min.	max.	min.	max.
mm		µm											
2,5	6	0	7	8	15	15	15	30	40	40	50		
6	10	0	7	10	20	20	30	35	45	45	55		
14	14	0	10	10	20	20	30	35	45	45	55		
10	24	5	15	10	20	20	30	35	45	45	55	65	75
24	20	5	15	10	25	25	35	40	50	50	60	70	80
30	40	5	15	12	25	25	40	45	55	55	70	80	95
40	50	5	18	15	30	30	45	50	65	65	80	95	110
50	65	5	20	15	35	35	50	55	75	75	90	110	130
65	80	10	25	20	40	40	60	70	90	90	110	130	150
80	100	10	30	25	45	45	70	80	105	105	125	155	180
100	120	10	30	25	50	50	80	95	120	120	145	180	205
120	140	10	35	30	60	60	90	105	135	135	160	200	230
140	160	10	35	35	65	65	100	115	150	150	180	225	260
160	180	10	40	35	75	75	110	125	165	165	200	250	285
180	200	15	45	40	80	80	120	140	180	180	220	275	315
200	225	15	50	45	90	90	135	155	200	200	240	305	350
225	250	15	50	50	100	100	150	170	215	215	265	330	380
250	280	20	55	55	110	110	165	185	240	240	295	370	420
280	315	20	60	60	120	120	180	205	265	265	325	410	470
315	355	20	65	65	135	135	200	225	295	295	360	455	520
355	400	25	75	75	150	150	225	255	330	330	405	510	585
400	450	25	85	85	170	170	255	285	370	370	455	565	650
450	500	25	95	95	190	190	285	315	410	410	505	625	720
500	560	25	100	105	210	210	315	350	455	455	560	720	815
560	630	30	110	115	230	230	345	390	505	505	620	800	910
630	710	30	130	130	260	260	390	435	565	565	695	900	1030
710	800	35	140	145	290	290	435	485	630	630	775	1000	1140
800	900	35	160	160	320	320	480	540	700	700	860	1130	1290
900	1000	35	180	180	360	360	540	600	780	780	960	1270	1440
1000	1120	50	200	200	400	400	600	660	860	860	1060	1380	1560
1120	1250	60	220	220	440	440	660	730	950	950	1170	1520	1720
1250	1400	60	240	240	480	480	720	810	1050	1050	1290	1680	1900
1400	1600	70	270	270	540	540	810	910	1190	1190	1460	1900	2150

1) Radial clearance for bearings with tapered bore is staggered with one group to the right, for example radial clearance C3NA for cylindrical bore bearings match radial clearance NA for tapered bore bearings.



## Minimum load

Cylindrical roller bearings must be subjected to a given minimum load, so that a proper operation of these bearings can be guaranteed.

This is necessary especially as the bearings are operated at high speeds and the centrifugal forces







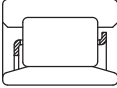
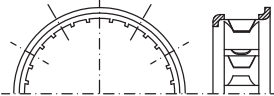
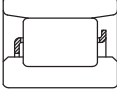

produce additional friction in bearing due to the sliding between rollers and raceway.

The values of the minimum load can be enough accurately calculated using the equation:

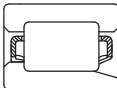
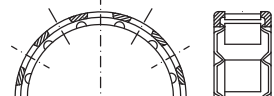
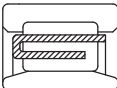
$$F_m = 0,02 C_1, \text{ kN}$$

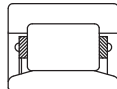
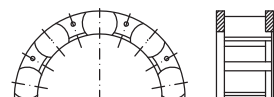
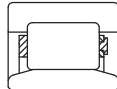
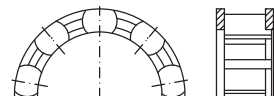
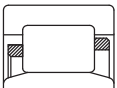
**Cage design and some technical data**

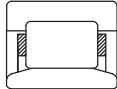
Table 4

Cage	Design		Application	Max. value $D_m n$	
	bearing	cage		oil	grease
Pressed sheet cage with fins			<ul style="list-style-type: none"> <li>- General application</li> <li>- Low inertia</li> <li>- Provides proper bearing lubrication</li> <li>- Moderate speeds</li> <li>- Bearings NU, NJ, NUP</li> </ul>	550x10 <sup>3</sup>	400x10 <sup>3</sup>
Pressed sheet cage with fins			<ul style="list-style-type: none"> <li>- General application</li> <li>- Low inertia</li> <li>- Provides proper bearing lubrication</li> <li>- Moderate speeds</li> <li>- Bearings N</li> </ul>	550x10 <sup>3</sup>	400x10 <sup>3</sup>
Pressed sheet cage			<ul style="list-style-type: none"> <li>- General application</li> <li>- Low inertia</li> <li>- Provides proper bearing lubrication</li> <li>- Moderate speeds</li> <li>- Bearings construction E type NU, NJ, NUP</li> </ul>	550x10 <sup>3</sup>	400x10 <sup>3</sup>
Pressed sheet cage with fins			<ul style="list-style-type: none"> <li>- General application</li> <li>- Low inertia</li> <li>- Provides proper bearing lubrication</li> <li>- Moderate speeds</li> <li>- Bearings NU, NJ, NUP</li> </ul>	550x10 <sup>3</sup>	400x10 <sup>3</sup>
Machined brass cage M, MA, MB			<ul style="list-style-type: none"> <li>- General application</li> <li>- Heavy loads</li> <li>- Moderate and high speeds</li> <li>- Bearings with <math>d &gt; 100</math> mm</li> </ul>	1200x10 <sup>3</sup>	900x10 <sup>3</sup>
Machined brass cage M6, MA6			<ul style="list-style-type: none"> <li>- General application</li> <li>- Heavy loads</li> <li>- Moderate and high speeds</li> </ul>	1200x10 <sup>3</sup>	900x10 <sup>3</sup>
Polyamide cage TN			<ul style="list-style-type: none"> <li>- General application</li> <li>- Low frictional moment</li> <li>- High speeds</li> <li>- Low noise <math>T &lt; 120^\circ \text{C}</math></li> </ul>	1400x10 <sup>3</sup>	1100x10 <sup>3</sup>
One piece machined brass cage MPA			<ul style="list-style-type: none"> <li>- General application</li> <li>- Heavy loads</li> <li>- Provides proper lubrication</li> <li>- High speeds</li> </ul>	1400x10 <sup>3</sup>	1100x10 <sup>3</sup>



**Equivalent dynamic radial load**

For cylindrical roller bearings purely radially loaded which don't locate shafts axially, equivalent dynamic load is:

$$P_r = F_r, \text{ kN}$$

If cylindrical roller bearings have ribs on the outer and inner rings and locate shafts axially in one or both directions, equivalent dynamic load can be calculated using the equations:

$$P_r = F_r, \text{ kN}, \quad \text{when } F_a/F_r \leq e$$

$$P_r = 0,92 F_r + Y F_a, \text{ kN}, \quad \text{when } F_a/F_r > e$$

Where:

- e - calculation factor with values:
  - 0,2 for series 10,2,3 and 4
  - 0,3 for series 22,23
- Y - factor for axial load
  - 0,6 for series 10,2,3 and 4
  - 0,4 for series 22,23

Cylindrical roller bearings axially loaded run satisfactorily only if they are simultaneously radially loaded. Ratio  $F_a/F_r$  should not exceed 0,5 for bearings of E design and 0,4 for the other bearings.

**Equivalent static radial load**

For cylindrical roller bearings purely radially loaded, equivalent static load is:

$$P_{or} = F_r, \text{ kN}$$

**Dynamic axial load**

Bearings with ribs on the outer ring can accommodate axial loads in addition to radial loads. The axial load carrying capacity of cylindrical roller bearings do not depend essentially on the steel fatigue strength, but on the resistance of the sliding surfaces at the roller end and rib contact and

therefore on lubrication, operating temperature and bearing thermal conductivity.

Considering the above mentioned, axial load carrying capacity of a cylindrical roller bearing can be enough accurately calculated using the following equation:

$$F_{a\max} = \frac{k_1 C_{Or} 10^4}{n(d + D)} - k_2 F_r,$$

where:

- $F_{a\max}$  - maximum permissible axial load, kN
- $C_{Or}$  - radial static load, kN
- $F_r$  - radial load component, kN
- n - operating speed, r/min
- d - bearing bore diameter, mm
- D - bearing outside diameter, mm
- $k_1$  - auxiliary factor, see table 5
- $k_2$  - auxiliary factor, see table 5

The above equation is based on conditions which are considered typical for normal bearing operation:

- a difference of 60°C between the bearing operating temperature and the ambient temperature
- a specific heat loss from the bearing of 0,5 mW/mm<sup>2</sup> °C
- a viscosity ratio  $k=2$ .

The viscosity ratio k is the ratio of the actual viscosity at the operating temperature to the requisite viscosity for a proper lubrication at that temperature. Further details can be found in subchapter "Adjusted rating life", life adjustment factor  $a_{23}$  - on page 21.

In case of grease lubrication, the base oil viscosity of the grease should be used. These effects can be reduced at low speeds by using oils with EP additives.

Factors $k_1$ and $k_2$		
Factor	Lubrication	
	oil	grease
<b>Bearings construction E</b>		
$k_1$	1,5	1
$k_2$	0,15	0,1
<b>Other bearings</b>		
$k_1$	0,5	0,3
$k_2$	0,05	0,03

The values of permissible axial load  $F_{a\max}$  obtained from the equation above mentioned are valid for a continuously acting constant axial load. If axial loads act only for short periods, the values may be multiplied by 2 or for shock loads by 3.

The constantly acting axial load  $F_{a\max}$  (N) should never exceed the numerical value of  $1,2 D^2$  ( $D$  = bearing outside diameter, mm) and occasional shock loads should never be greater than the numerical value of  $3D^2$ .

In case of heavy axial loads ( $F_a > D^2$ ), the ribs of the outer and inner ring respectively are recommended to be supported by the bearing ad joint parts. Bearings of NUP and NJ+HJ designs which take axial loads in both directions are to be placed so that main axial loads should be taken by fixed ribs, if bearing design allows.

### Heat treatment

Cylindrical roller bearings with outside diameter  $D > 240$  mm of all series given in the catalogue are to be subject to a heat treatment of stress relieving which allows bearings to be operated up to a temperature of  $+150^\circ\text{C}$ .

The hardness of rigs should not be less 59 HRC.

Small-sized bearings operate normally up to  $+120^\circ\text{C}$ .

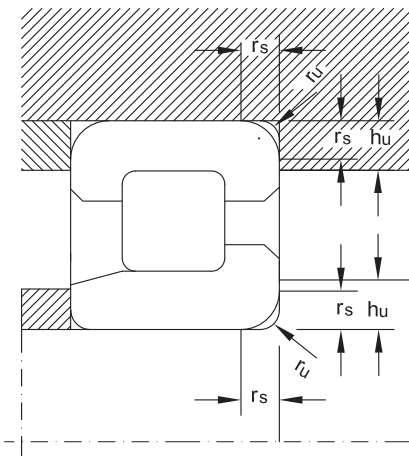

### Abutment dimensions

For a proper location of bearing rings on the shaft and housing shoulder respectively, shaft (housing) maximum radius  $r_{u\max}$  should be less than bearing minimum mounting chamfer  $r_{s\min}$ .

Shoulder height should also be properly sized in case of bearing maximum mounting chamfer.

The values of the connection radius and support shoulder height are given in table 6.

Abutment dimensions for single row cylindrical roller bearings are given in table 7. The values for double row cylindrical roller bearings are given in table 8.

Abutment dimensions <span style="float: right;">Table 6</span>				
$r_s, r_s$ min.	$r_u$ max.	$h_u$ min.		
		Bearing series		
		10, 18, 19, 28, 29, 30, 48, 49, 60	2, 2E, 3, 3E, 22, 22E, 23, 23E	4
mm				
0,3	0,3	1	1,2	
0,6	0,6	1,6	2,1	
1	1	2,3	2,8	
1,1	1	3	3,5	4,5
1,5	1,5	3,5	4,5	5,5
2	2	4,4	5,5	6,5
2,1	2,1	5,1	6	7
3	2,5	6,2	7	8
4	3	7,3	8,5	10
5	4	9	10	12
6	5	10	11	



### Single row cylindrical roller bearings

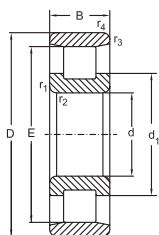

N

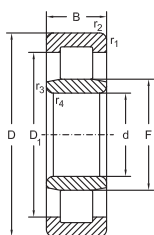

NU

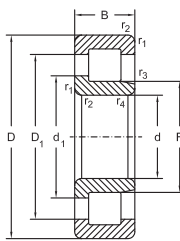

NJ

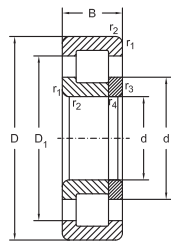

NUP

Dimensions						Basical radial load		Speed limit		Designation
d	D	B	r <sub>1</sub> , r <sub>2</sub> min.	r <sub>3</sub> , r <sub>4</sub> min.	s ≈	dyn. C <sub>r</sub>	stat. C <sub>10</sub>	grease	oil	
mm						kN		min <sup>-1</sup>		
15	35	11	0,6	0,3	1	12,7	10,4	18000	22000	NU202 E
	35	11	0,6	0,3	-	12,7	10,4	18000	22000	NJ202 E
17	40	12	0,6	0,3	1,2	17,6	14,6	15000	18000	N203
	40	12	0,6	0,3	1,2	17,6	14,6	15000	18000	NU203 E
	40	12	0,6	0,3	-	17,6	14,6	15000	18000	NJ203 E
	40	12	0,6	0,3	-	17,6	14,6	15000	18000	NUP203 E
	40	16	0,6	0,3	1	24	22	15000	18000	NU2203 E
	40	16	0,6	0,3	-	24	22	15000	18000	NJ2203 E
	40	16	0,6	0,3	-	24	22	15000	18000	NUP2203 E
	47	14	1,1	0,6	1,2	16,2	13	13000	16000	NU303 M
	47	14	1,1	0,6	-	16,2	13	13000	16000	NJ303 M
47	14	1,1	0,6	-	16,2	13	13000	16000	NUP303 M	
20	47	14	1	0,6	1	27,5	24,5	13000	16000	N204
	47	14	1	0,6	1	27,5	24,5	13000	16000	NU204 E
	47	14	1	0,6	1	27,5	24,5	13000	16000	NU204 EM6
	47	14	1	0,6	1	27,5	24,5	13000	16000	NU204 ETN
	47	14	1	0,6	-	27,5	24,5	13000	16000	NJ204 E
	47	14	1	0,6	-	27,5	24,5	13000	16000	NJ204 EMA6
	47	14	1	0,6	-	27,5	24,7	13000	16000	NJ204 ETN
	47	14	1	0,6	-	27,5	24,5	13000	16000	NUP204 E
	47	14	1	0,6	-	27,5	24,5	13000	16000	NUP204 EMA6
	47	18	1	0,6	1,8	32,5	31	13000	16000	NU2204 E
	47	18	1	0,6	1,8	32,5	31	13000	16000	NU2204 EMA6
	47	18	1	0,6	-	32,5	31	13000	16000	NJ2204 E
	47	18	1	0,6	-	32,5	31	13000	16000	NJ2204 EMA6
	47	18	1	0,6	-	32,5	31	13000	16000	NUP2204 E
	52	15	1	0,6	1,1	31,5	27	11000	14000	NU304 E
	52	15	1	0,5	1,1	31,5	27	11000	14000	NU304 EMA6
	52	15	1	0,6	-	31,5	27	11000	14000	NJ304 E
	52	15	1	0,5	-	31,5	27	11000	14000	NJ304 EM
52	15	1	0,5	-	31,5	27	11000	14000	NJ304 EMA6	
52	15	1,1	0,6	-	31,5	27	11000	14000	NUP304 E	
52	15	1,1	0,5	-	31,5	27	11000	14000	NUP304 EM	

## Single row cylindrical roller bearings

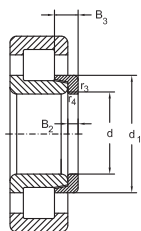

NJ+HJ

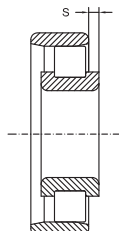
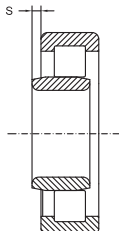

Abutment and fillet dimensions see on page 159

Dimensions							Thrust collar	Mass	
d	E	F	d <sub>1</sub> ≈	D <sub>1</sub> ≈	B <sub>2</sub>	B <sub>3</sub>	Designation	Bearing	Thrust collar
mm								kg	
15	-	19,3	-	27,8	-	-	-	0,05	-
	-	19,3	21,8	27,8	2,5	5	HJ202 E	0,05	0,007
17	33,9	-	24,7	-	-	-	-	0,07	-
	-	22,1	-	32	-	-	-	0,07	-
	-	22,1	24,7	32	3	5,5	HJ203 E	0,07	0,009
	-	22,1	24,7	32	-	-	-	0,07	-
	-	22,1	-	32	-	-	-	0,09	-
	-	22,1	24,7	32	3	6	HJ2203 E	0,09	0,01
	-	22,1	24,7	32	-	-	-	0,09	-
	-	25,1	-	36,8	-	-	-	0,12	-
	-	25,1	27,6	36,8	4	6,5	HJ303 E	0,12	0,012
-	25,1	27,6	36,8	-	-	-	0,12	-	
20	40	-	29,9	-	-	-	-	0,13	-
	-	26,5	-	38,8	-	-	-	0,13	-
	-	26,5	-	38,3	-	-	-	0,12	-
	-	26,5	-	38,7	-	-	-	0,11	-
	-	26,5	29,9	38,8	3	5,5	HJ204 E	0,13	0,011
	-	26,5	29,9	38,7	3	5	HJ204 E	0,13	0,011
	-	26,5	29,9	38,7	3	5	HJ204 E	0,12	0,011
	-	26,5	29,9	38,8	-	-	-	0,13	-
	-	26,5	29,9	38,7	-	-	-	0,15	-
	-	26,5	-	38,4	-	-	-	0,14	-
	-	26,5	-	38,7	-	-	-	0,16	-
	-	26,5	29,9	38,4	3	6,5	HJ2204 E	0,14	0,012
	-	26,5	29,7	38,7	3	6,5	HJ2204 E	0,17	-
	-	26,5	29,9	38,4	-	-	-	0,14	-
	-	27,5	-	41,8	-	-	-	0,15	-
	-	27,5	-	42,4	-	-	-	0,18	-
	-	27,5	31,4	41,8	4	6,5	HJ304 E	0,15	0,017
-	28,5	32	42	4	6,5	HJ304 E	0,17	0,017	
-	27,5	31	42,4	4	6,5	HJ304 E	0,18	0,017	
-	27,5	31,4	41,8	-	-	-	0,15	-	
-	27,5	31	42	-	-	-	0,17	-	



### Single row cylindrical roller bearings

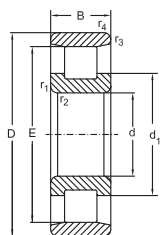

N

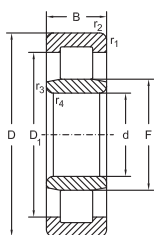

NU

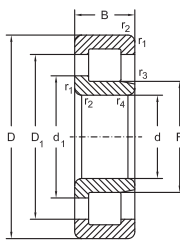

NJ

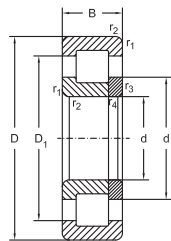

NUP

Dimensions						Basical radial load		Speed limit		Designation
d	D	B	r <sub>1</sub> , r <sub>2</sub> min.	r <sub>3</sub> , r <sub>4</sub> min.	s ≈	dyn. C <sub>r</sub>	stat. C <sub>10</sub>	grease	oil	
mm						kN		min <sup>-1</sup>		
20	52	15	1,1	0,5	-	31,5	27	11000	14000	NUP304 EMA6
	52	21	1,1	0,6	2	41,5	39	11000	14000	NU2304 E
	52	21	1,1	0,6	2	41,5	39	11000	14000	NU2304 EM
	52	21	1,1	0,6	-	41,5	39	11000	14000	NJ2304 E
	52	21	1,1	0,6	-	41,5	39	11000	14000	NJ2304 EM
	52	21	1,1	0,6	-	41,5	39	11000	14000	NUP2304 E
25	52	15	1	0,6	1,3	29	27,5	12000	15000	N205
	52	15	1	0,6	1,3	29	27,5	12000	15000	NU205 E
	52	15	1	0,6	1,3	29	27,5	12000	15000	NU205 EM6
	52	15	1	0,6	1,3	31	29,7	12000	15000	NU205 ETN
	52	15	1	0,6	-	29	27,5	12000	15000	NJ205 E
	52	15	1	0,6	-	29	27,5	12000	15000	NJ205 EM6
	52	15	1	0,6	-	29	27,5	12000	15000	NUP205 E
	52	15	1	0,6	-	29	27,5	12000	15000	NUP205 EM6
	52	18	1	0,6	1,7	34,5	35	12000	15000	NJ2205 E
	52	18	1	0,6	1,7	34,5	35	12000	15000	NU2205 EM6
	52	18	1	0,6	-	34,5	35	12000	15000	NJ2205 E
	52	18	1	0,6	-	34,5	35	12000	15000	NJ2205 EM6
	52	18	1	0,6	-	34,9	34,6	12000	15000	NJ2205 ETN
	52	18	1	0,6	-	34,5	35	12000	15000	NUP2205 E
	52	18	1	0,6	-	34,5	35	12000	15000	NUP2205 EM6
	62	17	1,1	1,1	1,3	41,5	37,5	9500	12000	N305
	62	17	1,1	1,1	1,3	41,5	37,5	9500	12000	NU305 E
	62	17	1,1	1,1	1,3	41,5	37,5	9500	12000	NU305 EM
	62	17	1,1	1,1	-	41,5	37,5	9500	12000	NJ305 E
	62	17	1,1	1,1	-	41,5	37,5	9500	12000	NJ305 EM
	62	17	1,1	1,1	-	41,6	37,4	9500	12000	NJ305 ETN
	62	17	1,1	1,1	-	41,5	37,5	9500	12000	NUP305 E
	62	17	1,1	1,1	-	41,5	37,5	9500	12000	NUP305 EM
	62	24	1,1	1,1	1,9	57	56	9500	12000	NU2305 E
62	24	1,1	1,1	-	57	56	9500	12000	NJ2305 E	
62	24	1,1	1,1	-	57	56	9500	12000	NJ2305 EM	

## Single row cylindrical roller bearings

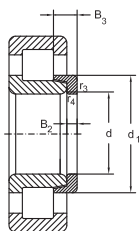

NJ+HJ

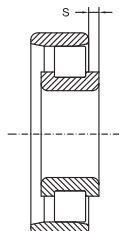
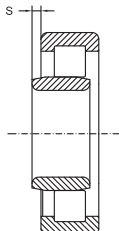

Abutment and fillet dimensions see on page 159

Dimensions							Thrust collar	Mass		
d	E	F	d <sub>1</sub> ≈	D <sub>1</sub> ≈	B <sub>2</sub>	B <sub>3</sub>	Designation	Bearing	Thrust collar	
mm								kg		
20	-	27,5	31	42,4	-	-	-	0,18	-	
	-	27,5	-	41,8	-	-	-	0,21	-	
	-	27,5	-	42	-	-	-	0,25	-	
	-	27,5	31,4	41,8	4	7,5	HJ2304 E	0,21	0,019	
	-	27,5	31,5	42	4	7,5	HJ2304 E	0,25	0,019	
	-	27,5	31,4	41,8	-	-	-	0,21	-	
25	-	27,5	31,5	42	-	-	-	0,33	-	
	45	-	35	-	-	-	-	0,13	-	
	-	31,5	-	43,3	-	-	-	0,14	-	
	-	31,5	-	43,6	-	-	-	0,15	-	
	-	31,5	-	44	-	-	-	0,13	-	
	-	31,5	34,9	43,3	3	6	HJ205 E	0,14	0,015	
	-	31,5	34,9	42	3	6	HJ205 E	0,16	0,015	
	-	31,5	34,9	43,3	-	-	-	0,14	-	
	-	31,5	34,9	42	-	-	-	0,16	-	
	-	31,5	-	43,3	-	-	-	0,16	-	
	-	31,5	-	43,6	-	-	-	0,19	-	
	-	31,5	34,9	43,3	3	6,5	HJ2205 E	0,16	0,015	
	-	31,5	34,1	43,6	3	6,5	HJ2205 E	0,19	0,015	
	-	31,5	34,1	43,6	3	6,5	HJ2205 E	0,17	0,015	
	-	31,5	34,9	43,3	-	-	-	0,16	-	
	-	31,5	34,1	43,6	-	-	-	0,20	-	
	53	-	39	-	-	-	-	-	0,25	-
	-	34	-	50,1	-	-	-	-	0,25	-
	-	34	-	50,5	-	-	-	-	0,29	-
	-	34	38,3	50,1	4	7	HJ305 E	0,25	0,025	
-	34	37,5	50,5	4	7	HJ305 E	0,29	0,025		
-	34	37,5	50,5	4	7	HJ305 E	0,24	0,025		
-	34	38,3	50,1	-	-	-	0,25	-		
-	34	37,5	50,5	-	-	-	0,30	-		
-	34	-	50,1	-	-	-	0,35	-		
-	34	38,3	50,1	4	8	HJ2305 E	0,35	0,027		
-	34	38,2	50,5	4	8	HJ2305 E	0,41	0,027		



### Single row cylindrical roller bearings

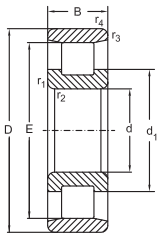

N

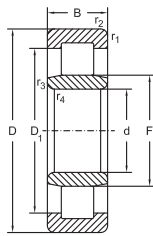

NU

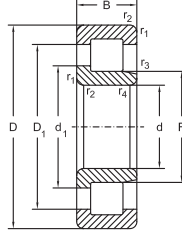

NJ

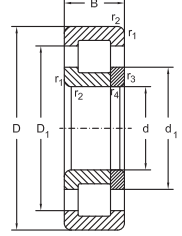

NUP

Dimensions						Basical radial load		Speed limit		Designation
d	D	B	r <sub>1</sub> , r <sub>2</sub> min.	r <sub>3</sub> , r <sub>4</sub> min.	s ≈	dyn. C <sub>r</sub>	stat. C <sub>10</sub>	grease	oil	
mm						kN		min <sup>-1</sup>		
25	62	24	1,1	1,1	-	57	56	9500	12000	NUP2305 E
	80	21	1,5	1,5	2,2	50,6	44,4	8500	10000	NU405 M
	80	21	1,5	1,5	-	50,6	44,4	8500	10000	NJ405 M
	80	21	1,5	1,5	-	50,6	44,4	8500	10000	NUP405 M
30	62	16	1	0,6	1,4	39,7	37,9	9500	12000	N206 EM6
	62	16	1	0,6	1,4	39,7	37,9	9500	12000	NU206 E
	62	16	1	0,6	1,4	39,7	37,9	9500	12000	NU206 EM6
	62	16	1	0,6	1,4	41,3	40,2	9500	12000	NU206 ETN
	62	16	1	0,6	-	39,7	37,9	9500	12000	NJ206 E
	62	16	1	1	-	39,7	37,9	9500	12000	NJ206 EM6
	62	16	1	1	-	39,7	37,9	9500	12000	NJ206 ETN
	62	16	1	0,6	-	39,7	37,9	9500	12000	NUP206 E
	62	16	1	1	-	39,7	37,9	9500	12000	NUP206 EM6
	62	20	1	0,6	1,6	49	50	9500	12000	NU2206 E
	62	20	1,5	1	1,6	49	50	9500	12000	NU2206 EMA6
	62	20	1	0,6	-	49	50	9500	12000	NU2206 ETN
	62	20	1	0,6	-	49	50	9500	12000	NJ2206 E
	62	20	1	0,6	-	49	50	9500	12000	NJ2206 EMA6
	62	20	1	0,6	-	52	54	9500	12000	NJ2206 ETN
	62	20	1	0,6	-	49	50	9500	12000	NUP2206 E
	72	19	1,1	1,1	1,9	51	48	8500	10000	N306
	72	19	1,1	1,1	1,9	51,2	48	8500	10000	NU306 E
	72	19	1,1	1,1	1,9	51,2	48	8500	10000	NU306 EM
	72	19	1,1	1,1	1,9	51,2	48	8500	10000	NU306 ETN
	72	19	1,1	1,1	-	51,2	48	8500	10000	NJ306 E
	72	19	1,1	1,1	-	51,2	48	8500	10000	NJ306 EM
	72	19	1,1	1,1	-	51,2	48	8500	10000	NJ306 ETN
	72	19	1,1	1,1	-	51,2	48	8500	10000	NUP306 E
72	19	1,1	1,1	-	51,2	48	8500	10000	NUP306 EM	
72	27	1,1	1,1	2,5	73,5	75	8500	10000	NU2306 E	
72	27	1,1	1,1	-	73,5	75	8500	10000	NJ2306 E	
72	27	1,1	1,1	-	73,5	75	8500	10000	NJ2306 EM	
72	27	1,1	1,1	-	73,5	75	8500	10000	NUP2306 E	



## Single row cylindrical roller bearings

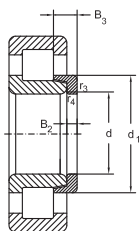

NJ+HJ

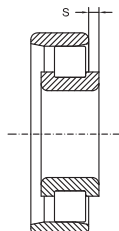
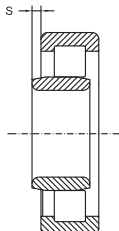

Abutment and fillet dimensions see on page 159

Dimensions							Thrust collar	Mass		
d	E	F	d <sub>1</sub> ≈	D <sub>1</sub> ≈	B <sub>2</sub>	B <sub>3</sub>	Designation	Bearing	Thrust collar	
mm								kg		
25	-	34	38,3	50,1	-	-	-	0,35	-	
	-	38,8	-	58,4	-	-	-	0,63	-	
	-	38,8	43,6	58,4	6	10,5	HJ405	0,63	0,057	
	-	38,8	43,4	57,5	-	-	-	0,65	-	
30	55,5	-	41,4	-	-	-	-	0,21	-	
	-	37,5	-	52	-	-	-	0,21	-	
	-	37,5	-	52,5	-	-	-	0,24	-	
	-	37,5	-	52,5	-	-	-	0,20	-	
	-	37,5	41,4	52	4	7	HJ206 E	0,21	0,025	
	-	37,5	40,7	50	4	7	HJ206 E	0,24	0,025	
	-	37,5	40,7	52,5	4	7	HJ206 E	0,20	0,025	
	-	37,5	41,4	52	-	-	-	0,21	-	
	-	37,5	40,7	52,5	-	-	-	0,25	-	
	-	37,5	-	52	-	-	-	0,26	-	
	-	37,5	-	52,25	-	-	-	0,31	-	
	-	37,5	-	52,25	-	-	-	0,26	-	
	-	37,5	41,4	52	4	7,5	HJ2206 E	0,26	0,025	
	-	37,5	40,7	52,25	4	7,5	HJ2206 E	0,31	0,025	
	-	37,5	40,7	52,25	4	7,5	HJ2206 E	0,26	0,025	
	-	37,5	41,4	52	-	-	-	0,26	-	
	62	-	46,4	-	-	-	-	-	0,36	-
	-	40,5	-	58,3	-	-	-	-	0,37	-
	-	40,5	-	58,5	-	-	-	-	0,43	-
	-	40,5	-	58,5	-	-	-	-	0,38	-
	-	40,5	45,1	58,3	5	8,5	HJ306 E	0,37	0,043	
	-	40,5	44,2	57,6	5	8,5	HJ306 E	0,45	0,043	
	-	40,5	44,2	57,6	5	8,5	HJ306 E	0,39	0,043	
-	40,5	45,1	58,3	-	-	-	0,37	-		
-	42	46,3	58,2	-	-	-	0,45	-		
-	40,5	-	58,3	-	-	-	0,53	-		
-	40,5	45,1	58,3	5	9,5	HJ2306 E	0,53	0,045		
-	40,5	44,2	58,6	5	9,5	HJ2306 E	0,63	0,045		
-	40,5	45,1	58,3	-	-	-	0,53	-		



### Single row cylindrical roller bearings

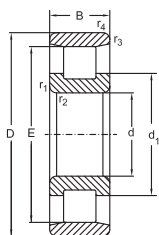

N

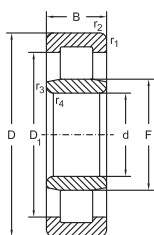

NU

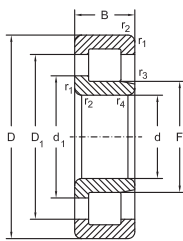

NJ

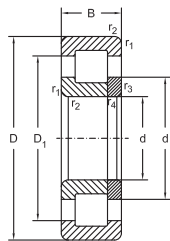

NUP

Dimensions						Basical radial load		Speed limit		Designation
d	D	B	r <sub>1</sub> , r <sub>2</sub> min.	r <sub>3</sub> , r <sub>4</sub> min.	s ≈	dyn. C <sub>r</sub>	stat. C <sub>10</sub>	grease	oil	
mm						kN		min <sup>-1</sup>		
30	90	23	1,5	1,5	2,3	65	57,8	7000	8500	N406 M
	90	23	1,5	1,5	2,3	65	57,8	7000	8500	NU406 M
	90	23	1,5	1,5	-	65	57,8	7000	8500	NJ406 M
	90	23	1,5	1,5	-	65	57,8	7000	8500	NUP406 M
35	62	14	1	0,6	1	23,6	24,5	10000	13000	NU1007 M
	72	17	1,1	0,6	1,7	50	50	8500	10000	N207
	72	17	1,1	0,6	1,7	50	50	8500	10000	NU207 E
	72	17	1,1	0,6	1,7	50	50	8500	10000	NU207 EM
	72	17	1,1	0,6	1,7	53	54	8500	10000	NU207 ETN
	72	17	1,1	0,6	-	50	50	8500	10000	NJ207 E
	72	17	1,1	0,6	-	53	54	8500	10000	NJ207 ETN
	72	17	1,1	0,6	-	50	50	8500	10000	NUP207 E
	72	17	1,1	0,6	-	50	50	8500	10000	NUP207 EM
	72	17	1,1	0,6	-	53	54	8500	10000	NUP207 ETN
	72	23	1,1	0,6	2,9	65	70	8500	10000	N2207
	72	23	1,1	0,6	2,9	65	70	8500	10000	NUP2207 E
	72	23	1	0,6	-	65	70	8500	10000	NJ2207 E
	72	23	1	0,6	-	65	70	8500	10000	NUP2207 E
	80	21	1,1	1,5	0,6	66,7	65,4	7500	9000	N307
	80	21	1,1	1,5	0,6	66,7	65,4	7500	9000	NU307 E
	80	21	1,5	1,1	0,6	66,7	65,4	7500	9000	NU307 EM
	80	21	1,1	1,5	-	66,7	65,4	7500	9000	NJ307 E
	80	21	1,5	1,1	-	66,7	65,4	7500	9000	NJ307 M
	80	21	1,1	1,5	-	66,7	65,4	7500	9000	NUP307 E
80	21	1,5	1,1	-	66,7	65,4	7500	9000	NUP307 EM	
80	31	1,1	1,5	3	91,5	98	7500	9000	N2307 E	
80	31	1,1	1,5	-	91,5	98	7500	9000	NJ2307 E	
80	31	1,5	1,1	-	91,5	98	7500	9000	NJ2307 EM	
80	31	1,1	1,5	-	91,5	98	7500	9000	NUP2307 E	
100	25	1,5	1,5	2,6	75	69,5	6300	7500	N407 M	
100	25	1,5	1,5	2,6	75	69,5	6300	7500	NU407 M	
100	25	1,5	1,5	-	75	69,5	6300	7500	NJ407 M	
100	25	1,5	1,5	-	75	69,5	6300	7500	NUP407 M	

## Single row cylindrical roller bearings

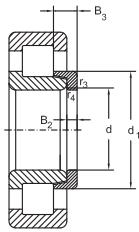

NJ+HJ

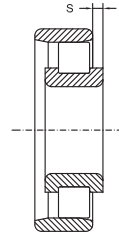
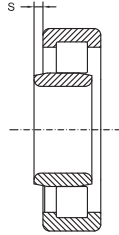

Abutment and fillet dimensions see on page 159

Dimensions							Thrust collar	Mass	
d	E	F	d <sub>1</sub> ≈	D <sub>1</sub> ≈	B <sub>2</sub>	B <sub>3</sub>	Designation	Bearing	Thrust collar
mm								kg	
30	73	-	50,5	-	-	-	-	0,87	-
	-	45	-	67,8	-	-	-	0,87	-
	-	45	50,5	67,8	7	11,5	<b>HJ406</b>	0,87	0,09
	-	45	50,5	67,8	-	-	-	0,87	-
35	-	42	44,5	51,9	4	7,75	<b>HJ1007</b>	0,18	0,02
	61,8	-	47,6	-	-	-	-	0,31	-
	-	44	-	60,1	-	-	-	0,31	-
	-	44	-	60,4	-	-	-	0,33	-
	-	44	-	60,4	-	-	-	0,31	-
	-	44	48	60,1	4	7	<b>HJ207 E</b>	0,31	0,033
	-	44	47,5	60,4	4	7	<b>HJ207 E</b>	0,32	0,033
	-	44	48	60,1	-	-	-	0,31	-
	-	44	47,5	60,4	-	-	-	0,34	-
	-	44	47,5	60,4	-	-	-	0,32	-
	61,8	-	47,6	-	-	-	-	0,38	-
	-	44	-	60,1	-	-	-	0,40	-
	-	44	48	60,1	4	8,5	<b>HJ2207 E</b>	0,40	0,035
	-	44	48	60,1	-	-	-	0,40	-
	68,2	-	51	-	-	-	-	0,47	-
	-	46,2	-	65,7	-	-	-	0,49	-
	-	46,2	-	66,2	-	-	-	0,56	-
	-	46,2	51,2	65,7	6	9,5	<b>HJ307 E</b>	0,49	0,062
	-	46,2	50,5	63,4	6	9,5	<b>HJ307 E</b>	0,54	0,065
	-	46,2	51,2	65,7	-	-	-	0,49	-
-	46,2	50,5	66,2	-	-	-	0,55	-	
-	46,2	-	65,7	-	-	-	0,72	-	
-	46,2	51,2	65,7	6	11	<b>HJ2307 E</b>	0,72	0,065	
-	46,2	50,3	66,3	6	11	<b>HJ2307 E</b>	0,84	0,065	
-	46,2	51,2	65,7	-	-	-	0,72	-	
83	-	59	-	-	-	-	1,05	-	
-	53	-	77,6	-	-	-	1,05	-	
-	53	59	77,6	8	13	<b>HJ407</b>	1,05	0,13	
-	53	59	77,6	-	-	-	1,05	-	



### Single row cylindrical roller bearings

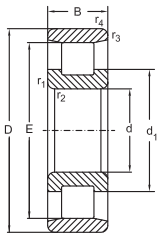

N

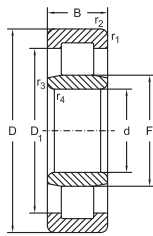

NU

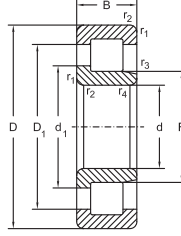

NJ

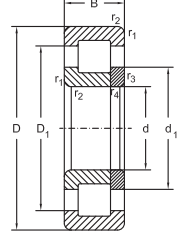

NUP

d	Dimensions					Basical radial load		Speed limit		Designation
	D	B	r <sub>1</sub> , r <sub>2</sub> min.	r <sub>3</sub> , r <sub>4</sub> min.	s ≈	dyn. C <sub>r</sub>	stat. C <sub>10</sub>	grease	oil	
40	mm					kN		min <sup>-1</sup>		
	68	15	1	0,6	-	26,1	27,3	9500	12000	NJ1008 M
	68	15	1,1	0,6	2,4	26,1	27,3	9500	12000	NU1008 M
	80	18	1,1	1,1	1,9	53	53	7500	9000	N208
	80	18	1,1	1,1	1,9	53,9	53	7500	9000	NU208 E
	80	18	1,1	1,1	1,9	53,9	53	7500	9000	NU208 EM
	80	18	1,1	1,1	1,9	53,9	53	7500	9000	NU208 ETN
	80	18	1,1	1,1	-	53,9	53	7500	9000	NJ208 E
	80	18	1,1	1,1	-	53,9	53	7500	9000	NJ208 EM
	80	18	1,1	1,1	-	53,9	53	7500	9000	NJ208 ETN
	80	18	1,1	1,1	-	53,9	53	7500	9000	NUP208 E
	80	18	1,1	1,1	-	53,9	53	7500	9000	NUP208 EM
	80	18	1,1	1,1	-	53,9	53	7500	9000	NUP208 ETN
	80	23	1,1	1,1	2,3	71	75	7500	9000	NU2208 E
	80	23	1,1	1,1	-	71	75	7500	9000	NJ2208 E
	80	23	1,1	1,1	-	73,6	79,6	7500	9000	NJ2208 ETN
	80	23	1,1	1,1	-	71	75	7500	9000	NUP2208 E
	90	23	1,5	1,5	1,5	81,5	78	6300	7500	N308
	90	23	1,5	1,5	1,5	81,5	78	6300	7500	NU308 E
	90	23	1,5	1,5	1,5	81,5	78	6300	7500	NU308 EM
	90	23	1,5	1,5	1,5	85,3	84,5	6300	7500	NU308 ETN
	90	23	1,5	1,5	-	81,5	78	6300	7500	NJ308 E
	90	23	1,5	1,5	-	81,5	78	6300	7500	NJ308 EM
	90	23	1,5	1,5	-	85,3	84,5	6300	7500	NJ308 ETN
	90	23	1,5	1,5	-	81,5	78	6300	7500	NUP308 E
	90	23	1,5	1,5	-	81,5	78	6300	7500	NUP308 EM
	90	33	1,5	1,5	3	112	120	6300	7500	NU2308 E
	90	33	1,5	1,5	3	112	120	6300	7500	NU2308 EM
90	33	1,5	1,5	-	112	120	6300	7500	NJ2308 E	
90	33	1,5	1,5	-	112	120	6300	7500	NJ2308 EM	
90	33	1,5	1,5	-	112	120	6300	7500	NUP2308 E	
90	33	1,5	1,5	-	112	120	6300	7500	NUP2308 EM	
110	27	2	2	2,6	93	86,5	5500	6800	N408 M	
110	27	2	2	2,6	93	86,5	5500	6800	NU408 M	

## Single row cylindrical roller bearings

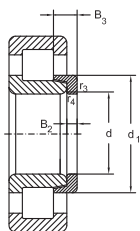

NJ+HJ

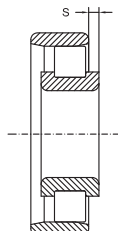
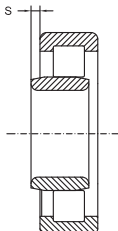

Abutment and fillet dimensions see on page 159

Dimensions							Thrust collar	Mass	
d	E	F	d <sub>1</sub> ≈	D <sub>1</sub> ≈	B <sub>2</sub>	B <sub>3</sub>	Designation	Bearing	Thrust collar
mm								kg	
40	-	47	50	57,6	4	8	HJ1008	0,23	0,03
	-	47	-	57,7	-	-	-	0,23	-
	70	-	54,4	-	-	-	-	0,40	-
	-	49,5	-	67,3	-	-	-	0,38	-
	-	49,5	-	67,5	-	-	-	0,44	-
	-	49,5	-	67,5	-	-	-	0,39	-
	-	49,5	54,1	67,3	5	8,5	HJ208 E	0,38	0,05
	-	50	54,4	67,5	5	8,5	HJ208 E	0,45	0,05
	-	49,5	53,2	67,5	5	8,5	HJ208 E	0,40	0,05
	-	49,5	54,1	67,3	-	-	-	0,38	-
	-	50	54,4	65,5	-	-	-	0,46	-
	-	50	54,4	67,5	-	-	-	0,41	-
	-	49,5	-	67,3	-	-	-	0,49	-
	-	49,5	54,1	67,3	5	9	HJ2208 E	0,49	0,05
	-	49,5	53,2	67,5	5	9	HJ2208 E	0,51	0,05
	-	49,5	54,1	67,3	-	-	-	0,49	-
	77,5	-	58,8	-	-	-	-	0,66	-
	-	52	-	74,9	-	-	-	0,65	-
	-	52	-	75	-	-	-	0,73	-
	-	52	-	75	-	-	-	0,66	-
	-	52	57,7	74,9	7	-	HJ308 E	0,66	0,088
	-	52	56,9	75	7	11	HJ308 E	0,75	0,088
	-	52	56,9	75	7	11	HJ308 E	0,67	0,088
	-	52	57,7	74,9	-	-	-	0,66	-
	-	52	56,9	75	-	-	-	0,70	-
	-	52	-	74,9	-	-	-	0,95	-
	-	52	-	75,4	-	-	-	1,24	-
	-	52	57,7	74,9	7	12,5	HJ2308 E	0,95	0,92
-	52	56,9	75,4	7	12,5	HJ2308 E	1,02	0,92	
-	52	57,7	74,9	-	-	-	0,95	-	
-	52	56,9	75,4	-	-	-	1,27	-	
92	-	64,8	-	-	-	-	1,30	-	
-	58	-	85,8	-	-	-	1,30	-	



### Single row cylindrical roller bearings

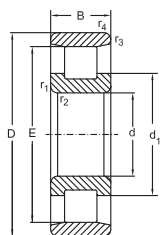

N

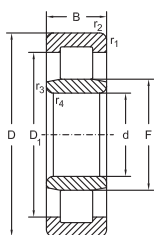

NU

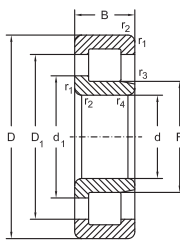

NJ

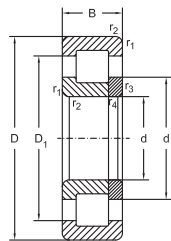

NUP

d	D	Dimensions				Basical radial load		Speed limit		Designation
		B	r <sub>1</sub> , r <sub>2</sub> min.	r <sub>3</sub> , r <sub>4</sub> min.	s ≈	dyn. C <sub>r</sub>	stat. C <sub>10</sub>	grease	oil	
		mm				kN		min <sup>-1</sup>		
40	110	27	2	2	-	93	86,5	5500	6800	NJ408 M
	110	27	2	2	-	93	86,5	5500	6800	NUP408 M
45	75	16	1	0,6	2,5	32,5	35,5	8500	10000	NU1009 M
	85	19	1,1	1,1	1,9	61	63	7000	8500	N209 E
	85	19	1,1	1,1	1,9	61	63	7000	8500	NU209 E
	85	19	1,1	1,1	1,9	61	63	7000	8500	NU209 EM
	85	19	1,1	1,1	1,9	63,2	67	7000	8500	NU209 ETN
	85	19	1,1	1,1	-	61	63	7000	8500	NJ209 E
	85	19	1,1	1,1	-	61	63	7000	8500	NJ209 EM
	85	19	1,1	1,1	-	61	63	7000	8500	NUP209 E
	85	19	1,1	1,1	-	61	63	7000	8500	NUP209 EM
	85	23	1,1	1,1	2,3	76	81,6	7000	8500	NU2209 E
	85	23	1,1	1,1	2,3	76	81,6	7000	8500	NU2209 EM
	85	23	1,1	1,1	-	76	81,6	7000	8500	NJ2209 E
	85	23	1,1	1,1	-	76	81,6	7000	8500	NJ2209 EM
	85	23	1,1	1,1	-	76	81,6	7000	8500	NUP2209 E
	85	23	1,1	1,1	-	76	81,6	7000	8500	NUP2209 EM
	100	25	1,5	1,5	2,9	98	100	5600	6700	N309 E
	100	25	1,5	1,5	2,9	98	100	5600	6700	NU309 E
	100	25	1,5	1,5	2,9	98	100	5600	6700	NU309 EM
	100	25	1,5	1,5	-	98	100	5600	6700	NJ309 E
	100	25	1,5	1,5	-	98	100	5600	6700	NJ309 EM
100	25	1,5	1,5	-	98	100	5600	6700	NUP309 E	
100	25	1,5	1,5	-	98	100	5600	6700	NUP309 EM	
100	36	1,5	1,5	3,5	137	153	5600	6700	NU2309 E	
100	36	1,5	1,5	3,5	137	153	5600	6700	NU2309 EM	
100	36	1,5	1,5	-	137	153	5600	6700	NJ2309 E	
100	36	1,5	1,5	-	137	153	5600	6700	NJ2309 EM	
100	36	1,5	1,5	-	137	153	5600	6700	NUP2309 E	
100	36	1,5	1,5	-	137	153	5600	6700	NUP2309 EM	
120	29	2	2	2,9	113	109	5000	6000	N409 M	
120	29	2	2	2,9	113	109	5000	6000	NU409 M	
120	29	2	2	-	113	109	5000	6000	NJ409 M	
120	29	2	2	-	113	109	5000	6000	NUP409 M	

## Single row cylindrical roller bearings

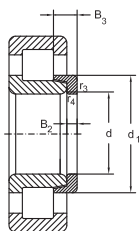

NJ+HJ

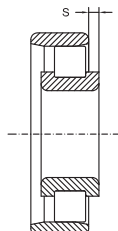
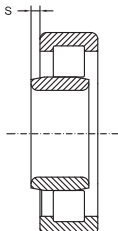

Abutment and fillet dimensions see on page 159

Dimensions							Thrust collar	Mass	
d	E	F	d <sub>1</sub> ≈	D <sub>1</sub> ≈	B <sub>2</sub>	B <sub>3</sub>	Designation	Bearing	Thrust collar
mm								kg	
40	-	58	64,8	85,8	8	13	HJ408	1,30	0,15
	-	58	64,8	85,8	-	-	-	1,30	-
45	-	52,5	55,5	63,9	-	-	-	0,29	-
	76,5	-	59,1	-	-	-	-	0,50	-
	-	54,5	-	72,4	-	-	-	0,50	-
	-	54,5	-	72,5	-	-	-	0,50	-
	-	54,5	-	72,5	-	-	-	0,44	-
	-	54,5	59,1	72,4	5	8,5	HJ209 E	0,50	0,05
	-	54,5	58,4	72,5	5	8,5	HJ209 E	0,50	0,05
	-	54,5	59,1	72,4	-	-	-	0,50	-
	-	54,5	58,4	72,5	-	-	-	0,51	-
	-	54,5	-	72,4	-	-	-	0,60	-
	-	54,5	-	72,6	-	-	-	0,59	-
	-	54,5	59,1	72,4	5	9	HJ2209 E	0,60	0,057
	-	54,5	58,4	72,6	5	9	HJ2209 E	0,58	0,057
	-	54,5	59,1	72,4	-	-	-	0,60	-
	88,5	-	64,6	-	-	-	-	1	-
	-	58,5	-	83,1	-	-	-	1	-
	-	58,5	-	83,2	-	-	-	1	-
	-	58,5	64,6	83,1	7	11,5	HJ309 E	1	0,11
	-	58,5	63,8	83,2	7	13	HJ309 E	1,02	0,11
	-	58,5	64,6	83,1	-	-	-	1	-
	-	58,5	63,8	83,2	-	-	-	1,03	-
	-	58,5	-	83,1	-	-	-	1,30	-
	-	58,5	-	83,5	-	-	-	1,44	-
	-	58,5	64,6	83,1	7	13	HJ2309 E	1,30	0,12
-	58,5	63,8	83,5	7	13	HJ2309 E	1,43	0,12	
-	58,5	64,6	83,1	-	-	-	1,30	-	
-	58,5	63,8	83,5	-	-	-	1,49	-	
100,5	-	71,8	-	-	-	-	1,70	-	
-	64,5	-	93,9	-	-	-	1,70	-	
-	64,5	71,8	93,9	8	13,5	HJ409	1,70	0,19	
-	64,5	71,8	93,9	-	-	-	1,70	-	



### Single row cylindrical roller bearings

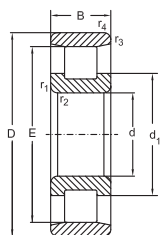

N

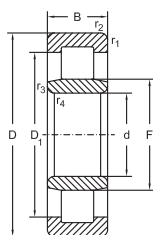

NU

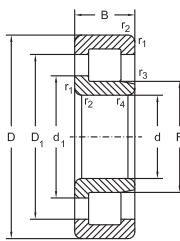

NJ

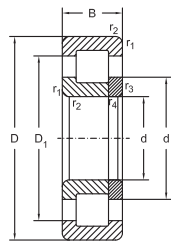

NUP

d	Dimensions					Basical radial load		Speed limit		Designation
	D	B	r <sub>1</sub> , r <sub>2</sub> min.	r <sub>3</sub> , r <sub>4</sub> min.	s ≈	dyn. C <sub>r</sub>	stat. C <sub>10</sub>	grease	oil	
50	mm					kN		min <sup>-1</sup>		
	80	16	1	0,6	2,5	36	41,5	8000	9500	NU1010 M
	90	20	1,1	1,1	2,2	64,4	68	6700	8000	N210 E
	90	20	1,1	1,1	2,2	64,4	68	6700	8000	NU210 E
	90	20	1,1	1,1	2,2	64,4	68	6700	8000	NU210 EM
	90	20	1,1	1,1	-	64,4	72,2	6700	8000	NJ210 ETN
	90	20	1,1	1,1	-	64,4	68	6700	8000	NJ210 EM
	90	20	1,1	1,1	-	64,4	68	6700	8000	NJ210 E
	90	20	1,1	1,1	-	64,4	68	6700	8000	NUP210 E
	90	20	1,1	1,1	-	64,4	68	6700	8000	NUP210 EM
	90	23	1,1	1,1	2,2	78	88	6700	8000	NU2210 E
	90	23	1,1	1,1	2,2	78	88	6700	8000	NU2210 EM
	90	23	1,1	1,1	-	78	88	6700	8000	NJ2210 E
	90	23	1,1	1,1	-	78	88	6700	8000	NJ2210 EM
	90	23	1,1	1,1	-	78	88	6700	8000	NUP2210 E
	110	27	2	2	3	110	114	5300	6300	N310 E
	110	27	2	2	3	110	114	5300	6300	NU310 E
	110	27	2	2	3	110	114	5300	6300	NU310 EM
	110	27	2	2	3	110	114	5300	6300	NU310 ETN
	110	27	2	2	-	110	114	5300	6300	NJ310 E
	110	27	2	2	-	110	114	5300	6300	NJ310 EM
	110	27	2	2	-	110	114	5300	6300	NJ310 ETN
	110	27	2	2	-	110	114	5300	6300	NUP310 E
	110	27	2	2	-	110	114	5300	6300	NUP310 EM
110	40	2	2	3,7	163	186	5300	6300	NU2310 E	
110	40	2	2	3,7	163	186	5300	6300	NU2310 EM	
110	40	2	2	-	163	186	5300	6300	NJ2310 E	
110	40	2	2	-	163	186	5300	6300	NJ2310 EM	
110	40	2	2	-	163	186	5300	6300	NUP2310 E	
110	40	2	2	-	163	186	5300	6300	NUP2310 EM	
130	31	2,1	2,1	3	139	136	4500	5300	N410 M	
130	31	2,1	2,1	3	139	136	4500	5300	NU410 M	
130	31	2,1	2,1	-	139	136	4500	5300	NJ410 M	
130	31	2,1	2,1	-	139	136	4500	5300	NUP410 M	



## Single row cylindrical roller bearings

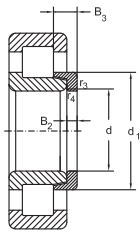

NJ+HJ

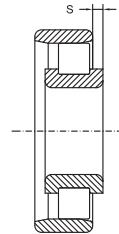
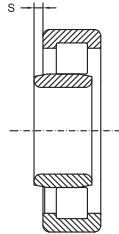

Abutment and fillet dimensions see on page 159

Dimensions							Thrust collar	Mass	
d	E	F	d <sub>1</sub> ≈	D <sub>1</sub> ≈	B <sub>2</sub>	B <sub>3</sub>	Designation	Bearing	Thrust collar
mm								kg	
50	-	57,5	60,5	68,9	-	-	-	0,32	-
	81,5	-	64,1	-	-	-	-	0,60	-
	-	59,5	-	77,4	-	-	-	0,60	-
	-	59,5	-	77,5	-	-	-	0,52	-
	-	59,5	63,2	77,5	5	9	<b>HJ210 E</b>	0,51	0,06
	-	59,5	63,2	77,5	5	9	<b>HJ210 E</b>	0,53	0,06
	-	59,5	64,1	77,4	5	9	<b>HJ210 E</b>	0,60	0,06
	-	59,5	64,1	77,4	-	-	-	0,60	-
	-	59,5	63,2	77,5	-	-	-	0,59	-
	-	59,5	-	77,4	-	-	-	0,65	-
	-	59,5	-	77,6	-	-	-	0,66	-
	-	59,5	64,1	77,4	5	9	<b>HJ2210 E</b>	0,65	0,06
	-	59,5	63,2	77,6	5	9	<b>HJ2210 E</b>	0,67	0,06
	-	59,5	64,1	77,4	-	-	-	0,65	-
	97	-	71,4	-	-	-	-	1,20	-
	-	65	-	91,4	-	-	-	1,20	-
	-	65	-	91,5	-	-	-	1,28	-
	-	65	-	91,5	-	-	-	1,14	-
	-	65	71,4	91,4	8	13	<b>HJ310 E</b>	1,20	0,15
	-	65	71,2	91,5	8	13	<b>HJ310 E</b>	1,27	0,15
	-	65	71,2	91,5	8	13	<b>HJ310 E</b>	1,16	0,15
	-	65	71,4	91,4	-	-	-	1,20	-
	-	65	71,2	91,5	-	-	-	1,31	-
	-	65	-	91,4	-	-	-	1,90	-
	-	65	-	91,5	-	-	-	1,94	-
	-	65	71,4	91,4	8	14,5	<b>HJ2310 E</b>	1,90	0,16
	-	65	70,5	91,5	8	14,5	<b>HJ2310 E</b>	1,97	0,16
	-	65	71,4	91,4	-	-	-	1,90	-
-	65	70,5	91,5	-	-	-	1,85	-	
110,8	-	78,8	-	-	-	-	2,10	-	
-	70,8	-	103,6	-	-	-	2,10	-	
-	70,8	78,8	103,6	9	14,5	<b>HJ410</b>	2,10	0,24	
-	70,8	78,8	103,6	-	-	-	2,20	-	



### Single row cylindrical roller bearings

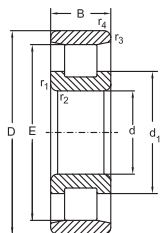

N

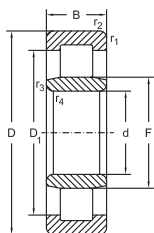

NU

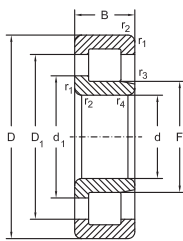

NJ

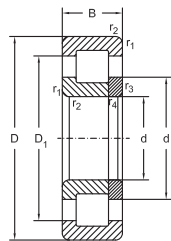

NUP

d	Dimensions					Basical radial load		Speed limit		Designation
	D	B	r <sub>1</sub> , r <sub>2</sub> min.	r <sub>3</sub> , r <sub>4</sub> min.	s ≈	dyn. C <sub>r</sub>	stat. C <sub>10</sub>	grease	oil	
55	mm					kN		min <sup>-1</sup>		
	90	18	1,1	1	2,6	41,5	50	7800	9200	<b>NU1011 M</b>
	90	18	1,1	1	-	37,7	43,8	8000	9500	<b>NJ1011 M</b>
	100	21	1,5	1,1	1,7	83	95	6300	7500	<b>N211</b>
	100	21	1,5	1,1	1,7	83	95	6300	7500	<b>NU211 E</b>
	100	21	1,5	1,1	1,7	83	95	6300	7500	<b>NU211 EM</b>
	100	21	1,5	1,1	-	83	95	6300	7500	<b>NU211 ETN</b>
	100	21	1,5	1,1	-	83	95	6300	7500	<b>NJ211 E</b>
	100	21	1,5	1,5	-	83	95	6300	7500	<b>NJ211 EM</b>
	100	21	1,5	1,5	-	83	95	6300	7500	<b>NJ211 ETN</b>
	100	21	1,5	1,1	-	83	95	6300	7500	<b>NUP211 E</b>
	100	21	1,5	1,5	-	83	95	6300	7500	<b>NUP211 EM</b>
	100	25	1,5	1,1	2,2	98	118	6300	7500	<b>NU2211 E</b>
	100	25	1,5	1,5	2,2	98	118	6300	7500	<b>NU2211 EM</b>
	100	25	1,5	1,1	-	98	118	6300	7500	<b>NJ2211 E</b>
	100	25	1,5	1,5	-	98	118	6300	7500	<b>NJ2211 EM</b>
	100	25	1,5	1,1	-	98	118	6300	7500	<b>NUP2211 E</b>
	100	25	1,5	1,5	2,2	98	118	6300	7500	<b>NUP2211 EM</b>
	120	29	2	r <sub>3</sub> , r <sub>4</sub>	3	134	140	5000	6000	<b>N311</b>
	120	29	2	2	3	134	140	5000	6000	<b>NU311 E</b>
	120	29	2	2	3	134	140	5000	6000	<b>NU311 EM</b>
	120	29	2	2	3	143	150	5000	6000	<b>NU311 ETN</b>
	120	29	2	2	-	134	140	5000	6000	<b>NJ311 E</b>
	120	29	2	2	-	134	140	5000	6000	<b>NJ311 EM</b>
	120	29	2	2	-	134	140	5000	6000	<b>NJ311 ETN</b>
	120	29	2	2	-	134	140	5000	6000	<b>NUP311 E</b>
	120	29	2	2	-	134	140	5000	6000	<b>NUP311 EM</b>
	120	43	2	2	3,8	187,3	212	5000	6000	<b>NU2311 EM</b>
120	43	2	2	-	187,3	212	5000	6000	<b>NJ2311 EM</b>	
120	43	2	2	-	187,3	212	5000	6000	<b>NUP2311 EM</b>	
140	33	2,1	2,1	3,3	140	137	4300	5000	<b>N411 M</b>	
140	33	2,1	2,1	3,3	140	137	4300	5000	<b>NU411 M</b>	
140	33	2,1	2,1	-	140	137	4300	5000	<b>NJ411 M</b>	
140	33	2,1	2,1	-	140	137	4300	5000	<b>NUP411 M</b>	

## Single row cylindrical roller bearings

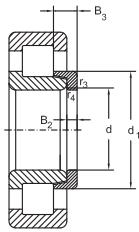

NJ+HJ

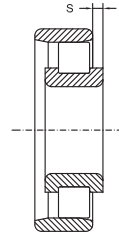
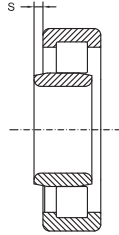

Abutment and fillet dimensions see on page 159

Dimensions							Thrust collar	Mass		
d	E	F	d <sub>1</sub> ≈	D <sub>1</sub> ≈	B <sub>2</sub>	B <sub>3</sub>	Designation	Bearing	Thrust collar	
mm								kg		
55	-	64,5	67,5	76,7	-	-	-	0,47	-	
	-	64,5	-	76,7	5	10	<b>HJ1011</b>	0,47	0,05	
	88,5	-	71,3	-	-	-	-	0,66	-	
	-	66	-	85,6	-	-	-	0,75	-	
	-	66	-	85,7	-	-	-	0,71	-	
	-	66	-	85,7	-	-	-	0,64	-	
	-	66	71	85,6	6	9,5	<b>HJ211 E</b>	0,75	0,09	
	-	66	70,8	85,7	6	9,5	<b>HJ211 E</b>	0,69	0,09	
	-	66	70,8	85,7	6	9,5	<b>HJ211 E</b>	0,66	0,09	
	-	66	71	85,6	-	-	-	0,75	-	
	-	66	70,8	85,7	-	-	-	0,72	-	
	-	66	-	85,6	-	-	-	0,90	-	
	-	66	-	85,9	-	-	-	0,88	-	
	-	66	71	85,6	6	10	<b>HJ2211 E</b>	0,90	0,09	
	-	66	70,9	85,9	6	10	<b>HJ2211 E</b>	0,90	0,09	
	-	66	71	85,6	-	-	-	0,90	-	
	-	66	70,9	85,9	-	-	-	0,92	-	
	104,5	-	77,2	-	-	-	-	-	1,54	-
	-	70,5	-	100,3	-	-	-	-	1,60	-
	-	70,5	-	100,5	-	-	-	-	1,80	-
	-	70,5	-	100,5	-	-	-	-	1,50	-
	-	70,5	77,7	100,3	9	14	<b>HJ311 E</b>	1,60	0,2	
	-	70,5	76,5	100,5	9	14	<b>HJ311 E</b>	1,85	0,2	
	-	70,5	76,5	100,5	9	14	<b>HJ311 E</b>	1,52	0,2	
	-	70,5	77,7	100,3	-	-	-	1,60	-	
	-	70,5	76,5	100,5	-	-	-	1,86	-	
	-	70,5	-	100,3	-	-	-	2,30	-	
	-	70,5	77,7	100,3	9	15,5	<b>HJ2311 E</b>	2,30	0,2	
-	70,5	77,7	100,3	-	-	-	2,30	-		
117,2	-	85,2	-	-	-	-	-	2,50	-	
-	77,2	-	109,9	-	-	-	-	2,50	-	
-	77,2	85,2	109,9	10	16,5	<b>HJ411</b>	2,50	0,31		
-	77,2	85,2	109,9	-	-	-	-	2,50	-	



### Single row cylindrical roller bearings

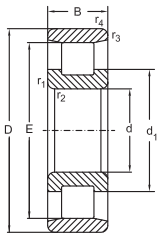

N

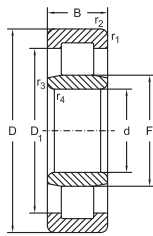

NU

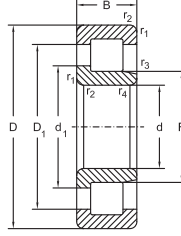

NJ

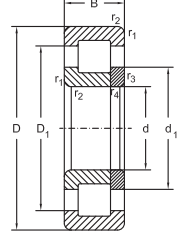

NUP

d	Dimensions					Basical radial load		Speed limit		Designation
	D	B	r <sub>1</sub> , r <sub>2</sub> min.	r <sub>3</sub> , r <sub>4</sub> min.	s ≈	dyn. C <sub>r</sub>	stat. C <sub>10</sub>	grease	oil	
60	mm					kN		min <sup>-1</sup>		
	95	18	1,1	1	2,8	47,8	56	6700	8000	<b>NU1012 EM</b>
	110	22	1,5	1,5	1,6	95	104	5600	6700	<b>N212 EM</b>
	110	22	1,5	1,5	1,6	95	104	5600	6700	<b>NU212 E</b>
	110	22	1,5	1,5	1,6	95	104	5600	6700	<b>NU212 EM</b>
	110	22	1,5	1,5	-	95	104	5600	6700	<b>NJ212 E</b>
	110	22	1,5	1,5	-	95	104	5600	6700	<b>NJ212 EM</b>
	110	22	1,5	1,5	-	98,4	108,7	5600	6700	<b>NJ212 ETN</b>
	110	22	1,5	1,5	-	95	104	5600	6700	<b>NUP212 E</b>
	110	22	1,5	1,5	-	95	104	5600	6700	<b>NUP212 EM</b>
	110	28	1,5	1,5	2,4	129	153	5300	6300	<b>NU2212 E</b>
	110	28	1,5	1,5	2,4	129	153	5600	6700	<b>NU2212 EM</b>
	110	28	1,5	1,5	-	129	153	5300	6300	<b>NJ2212 E</b>
	110	28	1,5	1,5	-	129	153	5600	6700	<b>NJ2212 EM</b>
	110	28	1,5	1,5	-	129	153	5300	6300	<b>NUP2212 E</b>
	110	28	1,5	1,5	-	129	153	5600	6700	<b>NUP2212 EM</b>
	130	31	2,1	2,1	3	150	156	4500	5300	<b>N312</b>
	130	31	2,1	2,1	3	150	156	4300	5000	<b>NU312 E</b>
	130	31	3,5	3,5	3	150	156	4500	5300	<b>NU312 EM</b>
	130	31	2,1	2,1	-	150	156	4300	5000	<b>NJ312 E</b>
	130	31	3,5	3,5	-	150	156	4500	5300	<b>NJ312 EM</b>
	130	31	2,1	2,1	-	150	156	4300	5000	<b>NUP312 E</b>
	130	31	2,1	2,1	-	150	156	4500	5300	<b>NUP312 EM</b>
	130	46	2,1	2,1	4	224	260	4300	5000	<b>NU2312 E</b>
130	46	2,1	2,1	4	224	260	4300	5000	<b>NU2312 EM</b>	
130	46	2,1	2,1	-	224	260	4300	5000	<b>NJ2312 E</b>	
130	46	2,1	2,1	-	224	260	4300	5000	<b>NUP2312 E</b>	
150	35	2,1	2,1	3,4	179	184	4000	4800	<b>N412 M</b>	
150	35	2,1	2,1	3,4	179	184	4000	4800	<b>NU412 M</b>	
150	35	2,1	2,1	-	179	184	4000	4800	<b>NJ412 M</b>	
150	35	2,1	2,1	-	179	184	4000	4800	<b>NUP412 M</b>	
65	100	18	1,1	1	3,3	45	58,5	6600	7800	<b>NU1013 M</b>
	100	18	1,1	1	3,3	45	58,5	6600	7800	<b>N1013 M</b>
	120	23	1,5	1,5	1,4	108	120	5300	6300	<b>N213</b>

## Single row cylindrical roller bearings

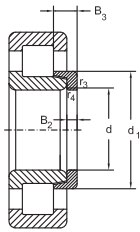

NJ+HJ

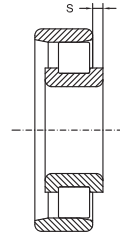
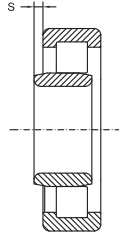

Abutment and fillet dimensions see on page 159

Dimensions							Thrust collar	Mass	
d	E	F	d <sub>1</sub> ≈	D <sub>1</sub> ≈	B <sub>2</sub>	B <sub>3</sub>	Designation	Bearing	Thrust collar
mm								kg	
60	-	68,5	-	82,6	-	-	-	0,47	-
	100	-	77,7	-	-	-	-	0,89	-
	-	72	-	95,1	-	-	-	1	-
	-	72	-	95,2	-	-	-	0,90	-
	-	72	77,7	95,1	6	10	HJ212 E	1	0,11
	-	72	76,9	95,2	6	10	HJ212 E	0,91	0,11
	-	72	76,9	95,2	6	10	HJ212 E	0,82	0,11
	-	72	77,7	95,1	-	-	-	1	-
	-	72	76,9	95,2	-	-	-	1	-
	-	72	-	95,1	-	-	-	1,20	-
	-	72	-	95,2	-	-	-	1,27	-
	-	72	77,7	95,1	6	10	HJ2212 E	1,20	0,11
	-	72	76,9	92,2	6	10	HJ2212 E	1,29	0,11
	-	72	77,7	95,1	-	-	-	1,20	-
	-	73,5	78,8	99,6	-	-	-	1,31	-
	113	-	85	-	-	-	-	1,80	-
	-	77	-	108,5	-	-	-	1,90	-
	-	77	-	109,5	-	-	-	1,97	-
	-	77	84,5	108,5	9	14,5	HJ312 E	1,90	0,24
	-	77	83	109,5	9	14,5	HJ312 E	2,16	0,24
-	77	84,5	108,5	-	-	-	1,90	-	
-	77	83	109,5	-	-	-	2,04	-	
-	77	-	108,5	-	-	-	2,90	-	
-	77	-	109	-	-	-	2,97	-	
-	77	84,5	108,5	9	16	HJ2312 E	2,90	0,24	
-	77	84,5	108,5	-	-	-	2,90	-	
127	-	91,8	-	-	-	-	3,10	-	
-	83	-	118,8	-	-	-	3,10	-	
-	83	91,8	118,8	10	16,5	HJ412	3,10	0,35	
-	83	91,8	118,8	-	-	-	3,10	-	
65	-	74,5	77,5	86,7	-	-	-	0,52	-
	90,5	-	77,9	-	5	10	HJ1013	0,49	0,07
	105,6	-	85,4	-	-	-	-	1,06	-



### Single row cylindrical roller bearings

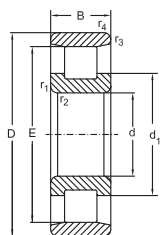

N

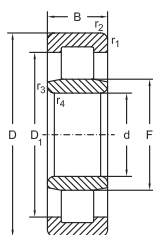

NU

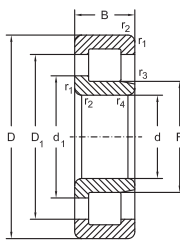

NJ

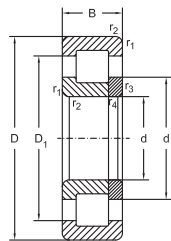

NUP

d	Dimensions					Basical radial load		Speed limit		Designation
	D	B	r <sub>1</sub> , r <sub>2</sub> min.	r <sub>3</sub> , r <sub>4</sub> min.	s ≈	dyn. C <sub>r</sub>	stat. C <sub>10</sub>	grease	oil	
	mm					kN		min <sup>-1</sup>		
65	120	23	1,5	1,5	1,4	108	120	5300	6300	NU213 E
	120	23	1,5	1,5	1,4	108	120	5300	6300	NU213 EM
	120	23	1,5	1,5	1,4	108	120	5300	6300	NU213 EM6
	120	23	1,5	1,5	-	108	120	5300	6300	NJ213 E
	120	23	1,5	1,5	-	108	120	5300	6300	NJ213 EM
	120	23	1,5	1,5	-	108	120	5300	6300	NUP213 E
	120	23	1,5	1,5	-	108	120	5300	6300	NUP213 EM
	120	31	1,5	1,5	2,5	147	178	4800	5600	NU2213 EM
	120	31	1,5	1,5	-	147	178	4800	5600	NJ2213 EM
	120	31	1,5	1,5	-	147	178	4800	5600	NUP2213 EM
	140	33	2,1	2,1	1,4	180	190	4300	5000	N313 EM
	140	33	2,1	2,1	1,4	180	190	4300	5000	NU313 E
	140	33	3,5	3,5	1,4	180	190	4300	5000	NU313 EM
	140	33	2,1	2,1	-	180	190	4300	5000	NJ313 E
	140	33	2,1	2,1	-	180	190	4300	5000	NJ313 EM
	140	33	2,1	2,1	-	180	190	4300	5000	NUP313 E
140	33	3,5	3,5	-	180	190	4300	5000	NUP313 EM	
140	48	2,1	2,1	4,2	245	285	4000	4800	NU2313 EM	
140	48	2,1	2,1	-	245	285	4000	4800	NJ2313 EM	
140	48	2,1	2,1	-	245	285	4000	4800	NUP2313 EM	
160	37	2,1	2,1	3,5	195	203	3800	4500	N413 M	
160	37	2,1	2,1	3,5	195	203	3800	4500	NU413 M	
160	37	2,1	2,1	-	195	203	3800	4500	NJ413 M	
160	37	2,1	2,1	-	195	203	3800	4500	NUP413 M	
70	110	20	1,1	1	3,4	65	81,5	6000	7000	NU1014 M
	110	20	1,1	1,1	-	65	81,5	6000	7000	NJ1014 M
	125	24	1,5	1,5	1,1	120	137	5000	6000	N214 EM
	125	24	1,5	1,5	1,1	120	137	5000	6000	NU214 E
	125	24	1,5	1,5	-	120	137	5000	6000	NJ214 E
	125	24	1,5	1,5	-	120	137	5000	6000	NJ214 EM
	125	24	1,5	1,5	-	120	137	5000	6000	NUP214 E
	125	24	1,5	1,5	-	120	137	5000	6000	NUP214 EM
125	31	1,5	1,5	2,6	156	196	4800	5600	NU2214 E	

## Single row cylindrical roller bearings

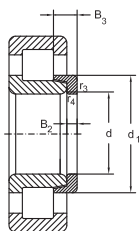

NJ+HJ

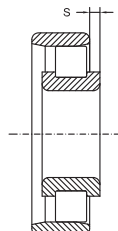
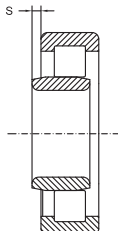

Abutment and fillet dimensions see on page 159

Dimensions							Thrust collar	Mass	
d	E	F	d <sub>1</sub> ≈	D <sub>1</sub> ≈	B <sub>2</sub>	B <sub>3</sub>	Designation	Bearing	Thrust collar
mm								kg	
65	-	78,5	-	103,2	-	-	-	1,20	-
	-	78,5	-	103,5	-	-	-	1,19	-
	-	78,5	-	103,5	-	-	-	1,19	-
	-	78,5	84,6	103,2	6	10	<b>HJ213 E</b>	1,20	0,13
	-	78,5	83,8	103,5	6	10	<b>HJ213 E</b>	1,22	0,13
	-	78,5	84,6	103,2	-	-	-	1,20	-
	-	78,5	83,8	103,5	-	-	-	1,14	-
	-	78,5	-	103,2	-	-	-	1,60	-
	-	78,5	84,6	103,2	6	10,5	<b>HJ2213 E</b>	1,60	0,13
	-	78,5	84,6	103,2	-	-	-	1,60	-
	124,5	-	89	-	-	-	-	2,30	-
	-	82,5	-	117,4	-	-	-	2,30	-
	-	82,5	-	118	-	-	-	2,45	-
	-	82,5	90,7	177,4	10	15,5	<b>HJ313 E</b>	2,30	0,29
	-	82,5	89	118	10	15,5	<b>HJ313 E</b>	2,49	0,29
	-	82,5	90,7	117,4	-	-	-	2,30	-
	-	82,5	89	118	-	-	-	2,55	-
	-	82,5	-	117,4	-	-	-	3,70	-
-	82,5	89	118	10	18	<b>HJ2313 E</b>	3,70	0,3	
-	82,5	89	118	-	-	-	3,70	-	
135,3	-	98,5	-	-	-	-	3,80	-	
-	89,3	-	126,9	-	-	-	3,80	-	
-	89,3	98,5	126,9	11	18	<b>HJ413</b>	3,80	0,43	
-	89,3	98,5	126,9	-	-	-	3,80	-	
70	-	80	84	95,3	-	-	-	0,75	-
	-	80	84	95,3	5	10	<b>HJ1014</b>	0,74	0,08
	113,5	-	88,8	-	-	-	-	1,30	-
	-	83,5	-	108,2	-	-	-	1,30	-
	-	83,5	89,6	108,2	7	11	<b>HJ214 E</b>	1,30	0,16
	-	83,5	88,8	108	7	11	<b>HJ214 E</b>	1,32	0,16
	-	83,5	89,6	108,2	-	-	-	1,30	-
	-	83,5	89	108	-	-	-	1,34	-
-	83,5	-	108,2	-	-	-	1,70	-	



### Single row cylindrical roller bearings

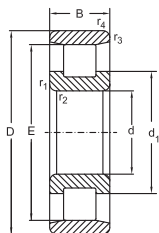

N

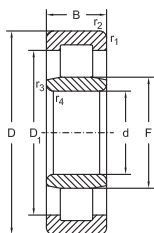

NU

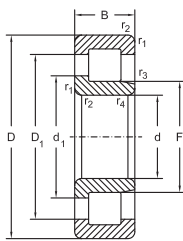

NJ

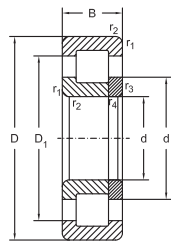

NUP

Dimensions						Basical radial load		Speed limit		Designation
d	D	B	r <sub>1</sub> , r <sub>2</sub> min.	r <sub>3</sub> , r <sub>4</sub> min.	s ≈	dyn. C <sub>r</sub>	stat. C <sub>10</sub>	grease	oil	
mm						kN		min <sup>-1</sup>		
70	125	31	1,5	1,5	2,6	156	196	4800	5600	NU2214 EM
	125	31	1,5	1,5	-	156	196	4800	5600	NJ2214 E
	125	31	1,5	1,5	-	156	196	4800	5600	NJ2214 EM
	125	31	1,5	1,5	-	156	196	4800	5600	NUP2214 E
	125	31	1,5	1,5	-	156	196	4800	5600	NUP2214 EM
	150	35	2,1	2,1	1,6	205	222	4000	4800	N314
	150	35	2,1	2,1	1,6	205	222	4000	4800	NU314 E
	150	35	2,1	2,1	1,6	205	222	4000	4800	NU314 EM6
	150	35	2,1	2,1	-	205	222	4000	4800	NJ314 E
	150	35	2,1	2,1	-	205	222	4000	4800	NUP314 E
	150	35	2,1	2,1	-	205	222	4000	4800	NUP314 EM
	150	51	2,1	2,1	4,4	275	325	3800	4500	NU2314 E
	150	51	2,1	2,1	4,4	275	325	3800	4500	NU2314 EM6
	150	51	2,1	2,1	-	275	325	3800	4500	NJ2314 E
	150	50	2,1	2,1	-	275	325	3800	4500	NJ2314 EM6
150	51	2,1	2,1	-	275	325	3800	4500	NUP2314 E	
150	51	2,1	2,1	-	275	325	3800	4500	NUP2314 EM6	
75	180	42	3	3	4	240	253	3400	4000	N414 M
	180	42	3	3	4	240	253	3400	4000	NU414 M
	180	42	3	3	-	240	253	3400	4000	NJ414 M
	180	42	3	3	-	240	253	3400	4000	NUP414 M
	115	20	1,1	1	3,4	65,5	85	5600	6600	NU1015 M
	130	25	1,5	1,5	1,2	132	156	4800	5600	N215 E
	130	25	1,5	1,5	1,2	132	156	4800	5600	NU215 E
	130	25	1,5	1,5	1,2	132	156	4800	5600	NU215 EM
	130	25	1,5	1,5	-	132	156	4800	5600	NJ215 E
	130	25	1,5	1,5	-	132	156	4800	5600	NUP215 E
	130	25	1,5	1,5	-	132	156	4800	5600	NUP215 EM
	130	31	1,5	1,5	2,6	151	190	4000	4800	NU2215 EM
	130	31	1,5	1,5	-	151	190	4000	4800	NJ2215 EM
	130	31	1,5	1,5	-	151	190	4000	4800	NUP2215 EM
	160	37	2,1	2,1	1,8	240	265	4000	4800	N315 E
160	37	2,1	2,1	1,8	240	265	4000	4800	NU315 E	



## Single row cylindrical roller bearings

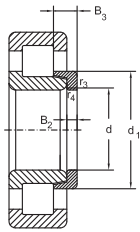

NJ+HJ

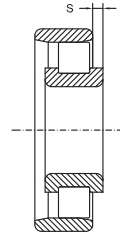
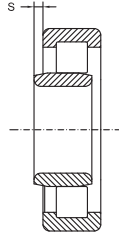

Abutment and fillet dimensions see on page 159

Dimensions							Thrust collar	Mass	
d	E	F	$d_1$ ≈	$D_1$ ≈	$B_2$	$B_3$	Designation	Bearing	Thrust collar
mm							-	kg	
70	-	83,5	-	108,2	-	-		-	1,97
	-	83,5	89,6	108,2	7	11,5	<b>HJ2214 E</b>	1,70	0,15
	-	83,5	88,8	108,2	7	11,5	<b>HJ2214 E</b>	1,74	0,15
	-	83,5	89,6	108,2	-	-	-	1,70	-
	-	83,5	88,8	108,2	-	-	-	1,62	-
	130	-	98,9	-	-	-	-	2,68	-
	-	89	-	125,6	-	-	-	2,80	-
	-	89	-	125,9	-	-	-	3,21	-
	-	89	97,5	125,6	10	15,5	<b>HJ314 E</b>	2,80	0,34
	-	89	97,5	125,6	-	-	-	2,80	-
	-	89	98,5	125,9	-	-	-	3,27	-
	-	89	-	125,6	-	-	-	4	-
	-	89	-	125,9	-	-	-	4,51	-
	-	89	97,5	125,6	10	18,5	<b>HJ2314 E</b>	4	0,35
	-	89	95,5	125,9	10	18,5	<b>HJ2314 E</b>	4,53	0,35
	-	89	97,5	125,6	-	-	-	4	-
-	89	95,9	125,9	-	-	-	4,27	-	
152	-	110,3	-	-	-	-	5,50	-	
-	100	-	142	-	-	-	5,50	-	
-	100	110,3	142	12	20	<b>HJ414</b>	5,50	0,61	
-	100	110,3	142	-	-	-	5,50	-	
75	-	85	89	100,9	-	-	-	0,75	-
	118,5	-	94,5	-	-	-	-	1,25	-
	-	88,5	-	113,2	-	-	-	1,25	-
	-	88,5	-	113	-	-	-	1,38	-
	-	88,5	94,5	113,2	7	11	<b>HJ215 E</b>	1,25	0,17
	-	88,5	94,5	113,2	-	-	-	1,25	-
	-	88,5	94	113	-	-	-	1,42	-
	-	88,5	-	113,2	-	-	-	1,60	-
	-	88,5	94,5	113,2	7	11,5	<b>HJ2215 E</b>	1,60	0,17
	-	88,5	94,5	113,2	-	-	-	1,60	-
	143	-	104,3	-	-	-	-	3,93	-
-	95	-	135	-	-	-	3,40	-	



### Single row cylindrical roller bearings

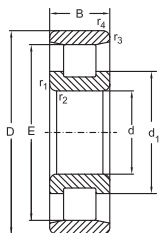

N

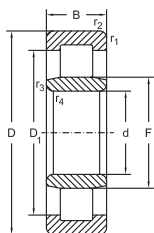

NU

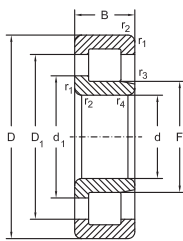

NJ

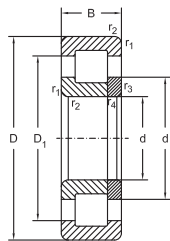

NUP

Dimensions						Basical radial load		Speed limit		Designation
d	D	B	r <sub>1</sub> , r <sub>2</sub> min.	r <sub>3</sub> , r <sub>4</sub> min.	s ≈	dyn. C <sub>r</sub>	stat. C <sub>10</sub>	grease	oil	
mm						kN		min <sup>-1</sup>		
75	160	37	3,5	3,5	1,8	240	265	4000	4800	NU315 EM
	160	37	2,1	2,1	-	240	265	4000	4800	NJ315 E
	160	37	2,1	2,1	-	240	265	4000	4800	NJ315 EM
	160	37	2,1	2,1	-	240	265	4000	4800	NUP315 E
	160	37	2,1	2,1	-	240	265	4000	4800	NUP315 EM
	160	55	2,1	2,1	4,5	329	395	4000	4800	NU2315 E
	160	55	2,1	2,1	4,5	329	395	4000	4800	NU2315 EM
	160	55	2,1	2,1	-	329	395	4000	4800	NJ2315 E
	160	55	2,1	2,1	-	329	395	4000	4800	NJ2315 EM
	160	55	2,1	2,1	-	329	395	4000	4800	NUP2315 E
80	190	45	3	3	4,2	277	294	4000	4800	N415 M
	190	45	3	3	4,2	277	294	4000	4800	NU415 M
	190	45	3	3	-	277	294	4000	4800	NJ415 M
	190	45	3	3	-	277	294	4000	4800	NJ415 EM
	190	45	3	3	-	277	294	4000	4800	NUP415 M
	125	22	1,1	1	3,6	76,5	98	5200	6200	NU1016 M
	125	16,5	2	2	3,6	68,2	85,2	5200	6200	NP1016 MB
	140	26	2	2	1,2	140	170	4300	5000	N216 E
	140	26	2	2	1,2	140	170	4300	5000	NU216 E
	140	26	2	2	1,2	140	170	4300	5000	NU216 EM
140	26	2	2	-	140	170	4300	5000	NJ216 E	
140	26	2	2	-	140	170	4300	5000	NJ216 EM	
140	26	2	2	-	140	170	4300	5000	NUP216 E	
140	26	2	2	-	140	170	4300	5000	NUP216 EM	
140	33	2	2	2,7	186	245	4300	5000	NU2216 EM	
140	33	2	2	-	186	245	4300	5000	NJ2216 EM	
140	33	2	2	-	186	245	4300	5000	NUP2216 EM	
170	39	2,1	2,1	2,1	255	275	3600	4300	N316	
170	39	2,1	2,1	2,1	255	275	3600	4300	NU316 E	
170	39	2,1	2,1	2,1	255	275	3600	4300	NU316 EM	
170	39	2,1	2,1	2,1	255	275	3600	4300	NU316 ETN	
170	39	2,1	2,1	-	255	275	3600	4300	NJ316 E	
170	39	2,1	2,1	-	255	275	3600	4300	NJ316 EM	
170	39	2,1	2,1	-	255	275	3600	4300	NUP316 E	

## Single row cylindrical roller bearings

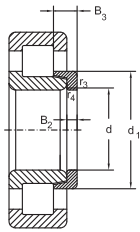

NJ+HJ

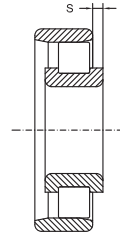
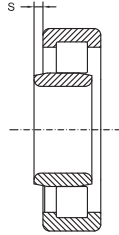

Abutment and fillet dimensions see on page 159

Dimensions							Thrust collar	Mass	
d	E	F	d <sub>1</sub> ≈	D <sub>1</sub> ≈	B <sub>2</sub>	B <sub>3</sub>	Designation	Bearing	Thrust collar
mm							Designation	kg	
75	-	95	-	135,5	-	-		-	3,83
	-	95	104,3	135	11	16,5	HJ315 E	3,40	0,42
	-	95	102,5	135,5	11	16,5	HJ315 E	3,87	0,42
	-	95	104,3	135	-	-	-	3,40	-
	-	95	102,5	135,5	-	-	-	3,83	-
	-	95	-	135	-	-	-	5	-
	-	95	-	135,5	-	-	-	5,54	-
	-	95	104,3	135	11	19,5	HJ2315 E	5	0,43
	-	95	102,5	135,5	11	19,5	HJ2315 E	5,62	0,43
	-	95	104,3	135	-	-	-	5	-
	-	95	102,5	135,5	-	-	-	5,30	-
	160,5	-	116	-	-	-	-	6,45	-
-	104,5	-	149,8	-	-	-	6,45	-	
-	104,5	116	149,8	13	21,5	HJ415	6,45	0,71	
-	104,5	116	149,8	-	-	-	6,45	-	
80	-	91,5	96	109,1	-	-	-	1,03	-
	113,5	-	96,2	110	-	-	-	1,05	-
	127,3	-	101,7	-	-	-	-	1,54	-
	-	95,3	-	121,6	-	-	-	1,54	-
	-	95,3	-	121,8	-	-	-	1,69	-
	-	95,3	101,7	121,6	8	12,5	HJ216 E	1,54	0,22
	-	95,3	101,7	121,6	-	-	-	1,54	-
	-	95,3	100,8	121,8	-	-	-	1,76	-
	-	95,3	-	121,6	-	-	-	2,34	-
	-	95,3	101,7	121,6	8	12,5	HJ2216 E	2,40	0,22
	-	95,3	101,7	121,6	-	-	-	2,52	-
	147	-	112,6	-	-	-	-	4,25	-
	-	101	-	142,7	-	-	-	3,95	-
	-	101	-	143,2	-	-	-	4,28	-
	-	101	-	143,2	-	-	-	3,93	-
	-	101	110,6	142,7	11	17	HJ316 E	3,95	0,47
-	101	108,7	143,2	11	17	HJ316 E	4,19	0,47	
-	101	110,6	142,7	-	-	-	3,95	-	



### Single row cylindrical roller bearings

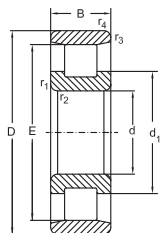

N

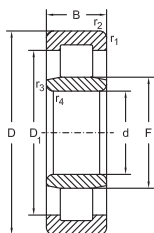

NU

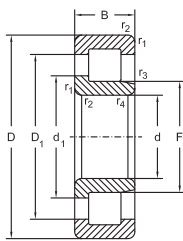

NJ

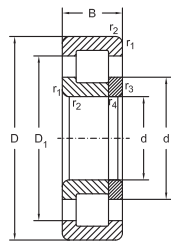

NUP

d	Dimensions					Basical radial load		Speed limit		Designation
	D	B	r <sub>1</sub> , r <sub>2</sub> min.	r <sub>3</sub> , r <sub>4</sub> min.	s ≈	dyn. C <sub>r</sub>	stat. C <sub>10</sub>	grease	oil	
mm										
						kN		min <sup>-1</sup>		
80	170	39	2,1	2,1	-	255	275	3600	4300	NUP316 EM
	170	58	2,1	2,1	5	352	424	3600	4300	NU2316 EM
	170	58	2,1	2,1	-	352	424	3600	4300	NJ2316 EM
	170	58	2,1	2,1	-	352	424	3600	4300	NUP2316 EM
	200	48	3	3	4,6	316	339	3000	3600	N416 M
	200	48	3	3	4,6	316	339	3000	3600	NU416 M
	200	48	3	3	-	316	339	3000	3600	NJ416 M
85	200	48	3	3	-	316	339	3000	3600	NUP416 M
	130	22	1,1	1	3,8	78	104	4800	5600	NU1017 M
	150	28	2	2	1,5	165	194	4300	5000	N217
	150	28	2	2	1,5	165	194	4300	5000	NU217 E
	150	28	2	2	1,5	165	194	4300	5000	NU217 EM
	150	28	2	2	-	165	194	4300	5000	NJ217 E
	150	28	2	2	-	165	194	4300	5000	NUP217 E
	150	28	2	2	-	165	114	4300	5000	NUP217 EM
	150	36	2	2	2,7	216	275	3800	4500	NU2217 E
	150	36	2	2	2,7	216	275	3800	4500	NU2217 EM
	150	36	2	2	-	216	275	3800	4500	NJ2217 E
	150	36	2	2	-	216	275	3800	4500	NJ2217 EM
	150	36	2	2	-	216	275	3800	4500	NUP2217 E
	150	36	2	2	-	216	275	3800	4500	NUP2217 EM
	180	41	3	3	2,3	288	325	3400	4000	N317 EMB
	180	41	3	3	2,3	288	325	3400	4000	NU317 E
	180	41	3	3	2,3	288	325	3400	4000	NU317 EM
	180	41	3	3	-	288	325	3400	4000	NJ317 E
	180	41	3	3	-	288	325	3400	4000	NJ317 EM
	180	41	3	3	-	288	325	3400	4000	NUP317 E
180	60	3	3	5	367	444	3400	4000	NU2317 EM	
180	60	3	3	-	367	444	3400	4000	NJ2317 EM	
180	60	3	3	-	367	444	3400	4000	NUP2317 EM	
210	52	4	4	5	357	384	2800	3400	N417 M	
210	52	4	4	5	357	384	2800	3400	NU417 M	
210	52	4	4	-	357	384	2800	3400	NJ417 M	

## Single row cylindrical roller bearings

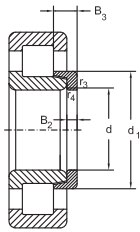

NJ+HJ

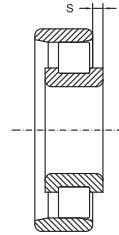
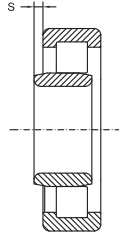

Abutment and fillet dimensions see on page 159

Dimensions							Thrust collar	Mass	
d	E	F	d <sub>1</sub> ≈	D <sub>1</sub> ≈	B <sub>2</sub>	B <sub>3</sub>	Designation	Bearing	Thrust collar
mm								kg	
80	-	101	108,8	143,2	-	-	-	4,59	-
	-	101	-	142,7	-	-	-	6,60	-
	-	101	110,6	142,7	11	20	<b>HJ2316 E</b>	6,70	0,5
	-	101	110,6	142,7	-	-	-	6,68	-
	170	-	122	-	-	-	-	8,30	-
	-	110	-	158,8	-	-	-	8,30	-
	-	110	122	158,8	13	22	<b>HJ416</b>	8,30	0,79
85	-	96,5	101	114,1	-	-	-	1,1	-
	133,8	-	108,8	-	-	-	-	1,9	-
	-	100,5	-	130,3	-	-	-	1,9	-
	-	100,5	-	130,5	-	-	-	2,12	-
	-	100,5	107,6	130,3	8	12,5	<b>HJ217 E</b>	1,9	0,25
	-	100,5	107,6	130,3	-	-	-	1,9	-
	-	100,5	107,5	130,5	-	-	-	2,23	-
	-	100,5	-	130,3	-	-	-	2,60	-
	-	100,5	-	130,5	-	-	-	2,76	-
	-	100,5	107,6	130,3	8	13	<b>HJ2217 E</b>	2,60	0,25
	-	100,5	106,5	130,5	8	13	<b>HJ2217 E</b>	2,87	0,25
	-	100,5	107,6	130,3	-	-	-	2,60	-
	-	100,5	106,5	130,5	-	-	-	2,80	-
	160	-	118	-	-	-	-	5,04	-
	-	108	-	151,3	-	-	-	5,30	-
	-	108	-	151,9	-	-	-	5,45	-
	-	108	118	151,3	12	18,5	<b>HJ317 E</b>	5,30	0,58
	-	108	116,5	151,9	12	18,5	<b>HJ317 E</b>	5	0,58
	-	108	118	151,3	-	-	-	5,30	-
	-	108	-	151,3	-	-	-	7,49	-
-	108	118	151,3	12	22	<b>HJ2317 E</b>	7,61	0,6	
-	108	118	151,3	-	-	-	7,77	-	
177	-	126	-	-	-	-	9,80	-	
-	113	-	164,8	-	-	-	9,80	-	
-	113	126	164,8	14	24	<b>HJ417</b>	9,80	0,92	



### Single row cylindrical roller bearings

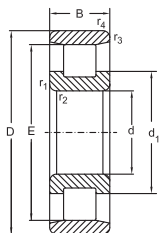

N

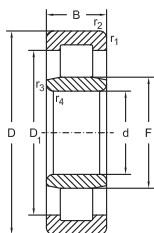

NU

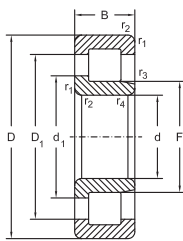

NJ

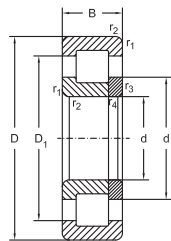

NUP

d	D	Dimensions				s ≈	Basical radial load		Speed limit		Designation
		B	r <sub>1</sub> , r <sub>2</sub> min.	r <sub>3</sub> , r <sub>4</sub> min.			dyn. C <sub>r</sub>	stat. C <sub>10</sub>	grease	oil	
		mm					kN		min <sup>-1</sup>		
85	210	52	4	4	-	357	384	2800	3400	NUP417 M	
	140	24	1,5	1,1	4	93	125	4500	5300	NU1018 M	
	160	30	2	2	1,8	183	216	3800	4500	N218 M	
	160	30	2	2	1,8	183	216	3800	4500	NU218 E	
	160	30	2	2	1,8	183	216	3800	4500	NU218 EM	
	160	30	2	2	-	183	216	3800	4500	NJ218 E	
	160	30	2	2	-	183	216	3800	4500	NJ218 EM	
	160	30	2	2	-	183	216	3800	4500	NUP218 E	
	160	30	2	2	-	183	216	3800	4500	NUP218 EM	
	160	40	2	2	2,9	240	315	3200	3800	NU2218 E	
	160	40	2	2	-	240	315	3200	3800	NJ2218 E	
	160	40	2	2	-	240	315	3200	3800	NUP2218 E	
	90	190	43	3	3	2,5	315	345	3200	3800	N318 EMB
		190	43	3	3	2,5	315	345	3200	3800	NU318 E
		190	43	3	3	2,5	315	345	3200	3800	NU318 EM
		190	43	3	3	2,5	329	374	3200	3800	NJ318 ETN
		190	43	3	3	-	315	345	3200	3800	NJ318 E
		190	43	3	3	-	315	345	3200	3800	NJ318 EM
		190	43	3	3	-	315	345	3200	3800	NUP318 E
		190	43	3	3	-	315	345	3200	3800	NUP318 EM
		190	64	3	3	6	430	530	3000	3600	NU2318 E
		190	64	3	3	6	430	530	3000	3600	NU2318 EM
190		64	3	3	-	430	530	3000	3600	NJ2318 E	
190		64	3	3	-	430	530	3200	3800	NJ2318 EM	
190		64	3	3	-	430	530	3000	3600	NUP2318 E	
95		225	54	4	4	5	393	427	2800	3400	N418 M
	225	54	4	4	5	393	427	2800	3400	NU418 M	
	225	54	4	4	-	393	427	2800	3400	NJ418 M	
	225	54	4	4	-	393	427	2800	3400	NUP418 M	
	145	24	1,5	1,1	4,1	96,5	129	4400	5200	NU1019 M	
	170	32	2,1	2,1	1,7	210	249	3800	4500	N219	
	170	32	2,1	2,1	1,7	210	249	3800	4500	NU219 EM	
	170	32	2,1	2,1	-	210	249	3800	4500	NJ219 EM	

## Single row cylindrical roller bearings

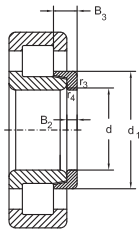

NJ+HJ

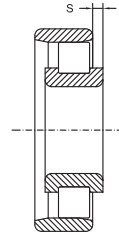
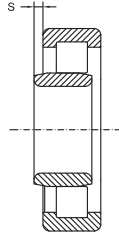

Abutment and fillet dimensions see on page 159

Dimensions							Thrust collar	Mass	
d	E	F	$d_1$ ≈	$D_1$ ≈	$B_2$	$B_3$	Designation	Bearing	Thrust collar
mm								kg	
85	-	113	126	164,8	-	-	-	9,80	-
	-	103	108	122,1	-	-	-	1,4	-
	143	-	114,2	-	-	-	-	2,59	-
	-	107	-	138,5	-	-	-	2,40	-
	-	107	-	139	-	-	-	2,73	-
	-	107	114,5	138,5	9	14	HJ218 E	2,70	0,33
	-	107	113	139	9	14	HJ218 E	2,79	0,33
	-	107	114,5	138,5	-	-	-	2,40	-
	-	107	113	139	-	-	-	2,84	-
	-	107	-	138,5	-	-	-	3,20	-
90	-	107	114,5	138,5	9	15	HJ2218 E	3,20	0,32
	-	107	114,5	138,5	-	-	-	3,20	-
	169,5	-	124	-	-	-	-	5,93	-
	-	113,5	-	160,2	-	-	-	5,40	-
	-	113,5	-	160,8	-	-	-	6,35	-
	-	115,5	-	160,8	-	-	-	5,50	-
	-	113,5	124	160,2	12	18,5	HJ318 E	5,40	0,63
	-	113,5	122,2	160,8	12	18,5	HJ318 E	6,14	0,63
	-	113,5	124	160,2	-	-	-	5,40	-
	-	113,5	122,2	160,8	-	-	-	6,22	-
	-	113,5	-	160,2	-	-	-	8,10	-
	-	113,5	-	154,3	-	-	-	8,82	-
	-	113,5	124	160,2	12	22	HJ2318 E	8,10	0,68
	-	113,5	122,2	154,3	12	22	HJ2318 E	9,02	0,68
	-	113,5	124	160,2	-	-	-	8,10	-
	191,5	-	137	-	-	-	-	11,50	-
-	123,5	-	178,8	-	-	-	11,50	-	
-	123,5	137	178,8	14	24	HJ418	11,50	1,1	
-	123,5	137	178,8	-	-	-	11,50	-	
95	-	108	113	127,1	-	-	-	1,45	-
	151,5	-	122	-	-	-	-	2,88	-
	-	112,5	-	147,4	-	-	-	3,24	-
	-	112,5	120,7	147,4	9	14	HJ219 E	3,25	0,35



### Single row cylindrical roller bearings

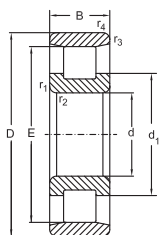

N

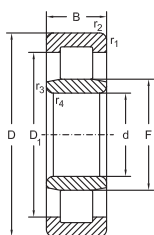

NU

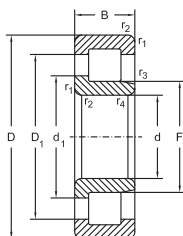

NJ

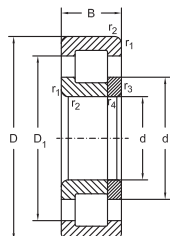

NUP

Dimensions					Basical radial load		Speed limit		Designation	
d	D	B	r <sub>1</sub> , r <sub>2</sub> min.	r <sub>3</sub> , r <sub>4</sub> min.	s ≈	dyn. C <sub>r</sub>	stat. C <sub>10</sub>	grease		oil
mm					kN		min <sup>-1</sup>			
95	170	32	2,1	2,1	-	210	249	3800	4500	NUP219 EM
	170	43	2,1	2,1	3,5	273	349	3200	3800	NU2219 EM
	170	43	2,1	2,1	-	273	349	3200	3800	NJ2219 EM
	170	43	2,1	2,1	-	273	349	3200	3800	NUP2219 EM
	200	45	3	3	2,9	311	351	3000	3600	N319
	200	45	3	3	2,9	311	351	3000	3600	NU319 EM
	200	45	3	3	-	311	351	3000	3600	NJ319 EM
	200	45	3	3	-	311	351	3000	3600	NUP319 EM
	200	67	3	3	6,2	388	488	2800	3400	N2319 M
	200	67	3	3	6,2	388	488	2800	3400	NU2319 M
	200	67	3	3	-	388	488	2800	3400	NJ2319 M
	200	67	3	3	-	388	488	2800	3400	NUP2319 M
	240	55	4	4	5,2	415	465	2400	3000	N419 M
	240	55	4	4	5,2	415	465	2400	3000	NU419 M
240	55	4	4	-	415	465	2400	3000	NJ419 M	
240	55	4	4	-	415	465	2400	3000	NUP419 M	
100	150	24	1,5	1,1	4,2	98	134	4300	5000	NU1020 M
	180	34	2,1	2,1	1,7	251	305	3200	3800	N220 E
	180	34	2,1	2,1	1,7	251	305	3200	3800	NU220 E
	180	34	2,1	2,1	1,7	251	305	3200	3800	NU220 EM
	180	34	2,1	2,1	-	251	305	3200	3800	NJ220 E
	180	34	2,1	2,1	-	251	305	3200	3800	NJ220 EM
	180	34	2,1	2,1	-	251	305	3200	3800	NUP220 E
	180	34	2,1	2,1	-	251	305	3200	3800	NUP220 EM
	180	46	2,1	2,1	3,5	335	440	3000	3800	NU2220 E
	180	46	2,1	2,1	3,5	335	440	3000	3800	NU2220 EM
	180	46	2,1	2,1	-	335	440	3000	3600	NJ2220 E
	180	46	2,1	2,1	-	335	440	3000	3600	NJ2220 EM
	180	46	2,1	2,1	-	335	440	3000	3600	NUP2220 E
	180	46	2,1	2,1	-	335	440	3000	3600	NUP2220 EM
	215	47	3	3	3	380	425	3000	3600	N320 E
	215	47	3	3	3	380	425	3000	3600	NU320 EM
215	47	3	3	3	380	425	3000	3600	NJ320 E	
215	47	3	3	3	380	425	3000	3600	NUP320 EM	



## Single row cylindrical roller bearings

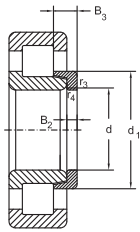

NJ+HJ

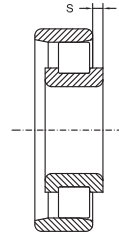
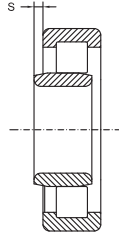

Abutment and fillet dimensions see on page 159

Dimensions							Thrust collar	Mass	
d	E	F	d <sub>1</sub> ≈	D <sub>1</sub> ≈	B <sub>2</sub>	B <sub>3</sub>	Designation	Bearing	Thrust collar
mm								kg	
95	-	112,5	120,7	147,4	-	-	-	3,33	-
	-	112,5	-	147,4	-	-	-	4,29	-
	-	112,5	120,7	147,4	9	15,5	<b>HJ2219 E</b>	4,38	0,37
	-	112,5	120,7	147,4	-	-	-	4,42	-
	173,5	-	133	-	-	-	-	6,47	-
	-	121,5	-	168,2	-	-	-	7	-
	-	121,5	132,2	168,2	13	20,5	<b>HJ319 E</b>	7,20	0,8
	-	121,5	132,2	168,2	-	-	-	7,26	-
	173,5	-	132	-	-	-	-	10,30	-
	-	121,5	-	168,2	-	-	-	10,50	-
	-	121,5	132,2	168,2	13	24,5	<b>HJ2319 E</b>	10,50	0,93
	-	121,5	132,2	168,2	-	-	-	10,90	-
100	201,5	-	147	-	-	-	-	13,80	-
	-	133,5	-	188,8	-	-	-	13,80	-
	-	133,5	147	188,8	15	25,5	<b>HJ419</b>	13,80	1,3
	-	133,5	147	188,8	-	-	-	13,80	-
	-	113	118	132,1	-	-	-	1,50	-
	163	-	127,3	-	-	-	-	3,44	-
	-	119	-	155,5	-	-	-	3,44	-
	-	119	-	157	-	-	-	3,77	-
	-	119	127,3	155,5	10	15	<b>HJ220 E</b>	3,44	0,44
	-	119	127	157	10	15	<b>HJ220 E</b>	3,49	0,44
	-	119	127,3	155,5	-	-	-	3,44	-
	-	119	127	164,5	-	-	-	3,89	-
	-	119	-	155,5	-	-	-	5,50	-
	-	120	-	159	-	-	-	5,23	-
	-	119	127,3	155,5	10	16	<b>HJ2220 E</b>	5,50	0,45
-	128	120	159	10	16	<b>HJ2220 E</b>	5,23	0,45	
-	119	127,3	155,5	-	-	-	5,50	-	
191,5	-	139,6	-	-	-	-	7,70	-	
185,5	-	138,5	-	-	-	-	8,59	-	
-	127,5	-	181	-	-	-	7,70	-	
-	127,5	-	173,5	-	-	-	8,73	-	



### Single row cylindrical roller bearings

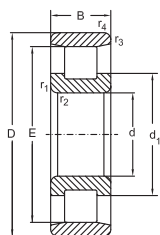

N

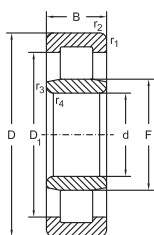

NU

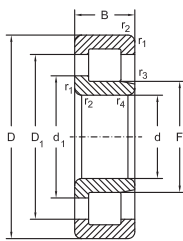

NJ

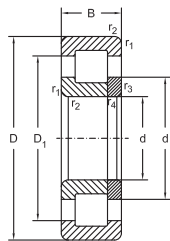

NUP

d	Dimensions					Basical radial load		Speed limit		Designation
	D	B	r <sub>1</sub> , r <sub>2</sub> min.	r <sub>3</sub> , r <sub>4</sub> min.	s ≈	dyn. C <sub>r</sub>	stat. C <sub>10</sub>	grease	oil	
mm										
						kN		min <sup>-1</sup>		
100	215	47	3	3	-	380	425	3000	3600	NJ320 E
	215	47	3	3	-	380	425	3000	3600	NJ320 EM
	215	47	3	3	-	380	425	3000	3600	NUP320 E
	215	73	3	3	6,3	570	720	2600	3200	NUP320 E
	215	73	3	3	-	570	720	2600	3200	NJ2320 E
	215	73	4	4	-	570	720	2600	3200	NJ2320 EM
	215	73	3	3	-	570	720	2600	3200	NUP2320 E
	250	58	4	4	5,7	440	490	2400	3000	N420 M
250	58	4	4	5,7	440	490	2400	3000	NU420 M	
250	58	4	4	-	440	490	2400	3000	NJ420 M	
250	58	4	4	-	440	490	2400	3000	NUP420 M	
105	160	26	2	1,1	4,4	112	153	3800	4500	NU1021 M
	160	26	2	2	-	112	153	3800	4500	NJ1021 M
	190	36	2,1	2,1	2	260	320	3000	3600	N221 E
	190	36	2,1	2,1	2	260	320	3000	3600	NU221 E
	190	36	2,1	2,1	-	260	320	3000	3600	NJ221 E
	190	36	2,1	2,1	-	260	320	3000	3600	NJ221 EM
	190	36	2,1	2,1	-	260	320	3000	3600	NUP221 E
	225	49	3	3	3	335	380	2600	3200	N321 E
	225	49	3	3	3	335	380	2600	3200	NU321 E
	225	49	3	3	3	335	380	2600	3200	NJ321 EM
	225	49	3	3	-	335	380	2600	3200	NJ321 E
	225	49	3	3	-	335	380	2600	3200	NJ321 EM
	225	49	3	3	-	335	380	2600	3200	NUP321 E
	260	60	4	4	5,7	490	540	2200	2800	NU421 M
260	60	4	4	-	490	540	2200	2800	NJ421 M	
260	60	4	4	-	490	540	2200	2800	NUP421 M	
110	170	28	2	1,1	4,5	140	190	3600	4500	NU1022 M
	200	38	2,1	2,1	2,1	292	365	3000	3600	N222 E
	200	38	2,1	2,1	2,1	292	365	3000	3600	NU222 E
	200	38	2,1	2,1	2,1	292	365	3000	3600	NJ222 EM
	200	38	2,1	2,1	-	292	365	3000	3600	NJ222 E
	200	38	2,1	2,1	-	292	365	3000	3600	NJ222 EM

## Single row cylindrical roller bearings

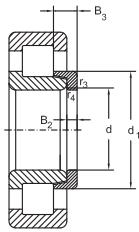

NJ+HJ

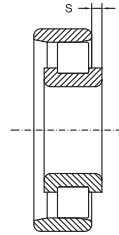
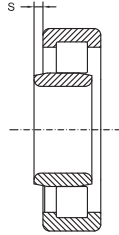

Abutment and fillet dimensions see on page 159

Dimensions							Thrust collar	Mass	
d	E	F	d <sub>1</sub> ≈	D <sub>1</sub> ≈	B <sub>2</sub>	B <sub>3</sub>	Designation	Bearing	Thrust collar
mm								kg	
100	-	127,5	139,6	181	13	20,5	HJ320 E	7,70	0,9
	-	127,5	139	173,5	13	20,5	HJ320 E	8,61	0,9
	-	127,5	139,6	181	-	-	-	7,70	-
	-	127,5	-	181	-	-	-	12	-
	-	127,5	139,6	181	13	23,5	HJ2320 E	12	0,95
	-	127,5	139	181,5	13	23,5	HJ2320 E	13,26	0,95
	-	127,5	139,6	181	-	-	-	12	-
	211	-	153,5	-	-	-	-	15,80	-
	-	139	-	197	-	-	-	15,80	-
-	139	153,5	197	16	27	HJ420	15,80	1,6	
-	139	153,5	197	-	-	-	15,80	-	
105	-	119,5	124,5	140,3	-	-	-	1,90	-
	-	119,5	-	140,3	7	13,5	HJ1021	1,91	0,24
	171,5	-	134,7	-	-	-	-	4,10	-
	-	125,5	-	163	-	-	-	4,10	-
	-	125,5	134,7	163	10	16	HJ221 E	4,10	0,52
	-	125,5	134,5	164,5	10	16	HJ221 E	4,56	0,52
	-	125,5	134,7	163	-	-	-	4,10	-
	195	-	147	-	-	-	-	9,10	-
	-	135	-	183,8	-	-	-	9,10	-
	-	133	-	191	-	-	-	9,91	-
	-	135	147	183,8	13	20,5	HJ321 E	9,10	1
	-	133	143	191	13	20,5	HJ321 E	10,03	1
	-	135	147	183,8	-	-	-	9,10	-
	-	144,5	-	206	-	-	-	17,50	-
-	144,5	159,5	206	16	27	HJ421	17,50	1,7	
-	144,5	159,5	206	-	-	-	17,50	-	
110	-	125	131	149	-	-	-	2,40	-
	180,5	-	141,6	-	-	-	-	4,90	-
	-	132,5	-	172,4	-	-	-	4,90	-
	-	132,5	-	174	-	-	-	5,30	-
	-	132,5	141,6	172,4	11	17	HJ222 E	4,90	0,62
	-	132,5	141	174	11	17	HJ222 E	5,40	0,62



### Single row cylindrical roller bearings

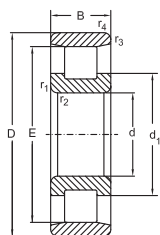

N

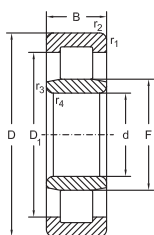

NU

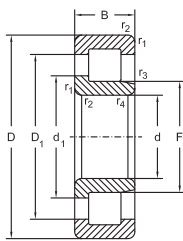

NJ

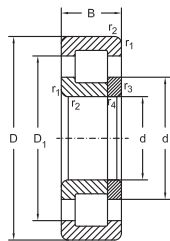

NUP

d	D	Dimensions				Basical radial load		Speed limit		Designation
		B	r <sub>1</sub> , r <sub>2</sub> min.	r <sub>3</sub> , r <sub>4</sub> min.	s ≈	dyn. C <sub>r</sub>	stat. C <sub>10</sub>	grease	oil	
mm										
kN										
min <sup>-1</sup>										
110	200	38	2,1	2,1	-	292	365	3000	3600	NUP222 E
	200	38	2,1	2,1	-	292	365	3000	3600	NUP222 EM
	200	53	2,1	2,1	4	380	520	2800	3400	NU2222 E
	200	53	2,1	2,1	4	380	520	2800	3400	NU2222 EM
	200	53	2,1	2,1	-	380	520	2800	3400	NJ2222 E
	200	53	2,1	2,1	-	380	520	2800	3400	NJ2222 EM
	200	53	2,1	2,1	-	380	520	2800	3400	NUP2222 E
	240	50	3	3	3,2	443	513	2400	3000	N322 E
	240	50	3	3	3,2	443	513	2400	3000	NU322 E
	240	50	3	3	3,2	443	513	2400	3000	NU322 EM
	240	50	3	3	-	443	513	2400	3000	NJ322 E
	240	50	3	3	-	443	513	2400	3000	NJ322 EM
	240	50	3	3	-	443	513	2400	3000	NUP322 EM
	240	80	3	3	7,2	630	800	2200	2800	NU2322 E
	240	80	3	3	7,2	630	800	2200	2800	NU2322 EM
	240	80	3	3	-	630	800	2200	2800	NJ2322 E
	240	80	3	3	-	630	800	2200	2800	NJ2322 EM
240	80	3	3	-	630	800	2200	2800	NUP2322 E	
280	65	4	4	6,2	583	672	2200	2800	NU422 M	
280	65	4	4	-	583	672	2200	2800	NJ422 M	
280	65	4	4	-	583	672	2200	2800	NUP422 M	
120	180	28	2	1	4,5	150	208	3400	4000	NU1024 M
	215	40	2,1	2,1	2,5	335	415	2600	3200	N224 E
	215	40	2,1	2,1	2,5	335	415	2600	3200	NU224 E
	215	40	2,1	2,1	2,5	335	415	2600	3200	NU224 EM
	215	40	2,1	2,1	2,5	335	415	2600	3200	NU224 EM6
	215	40	2,1	2,1	-	335	415	2600	3200	NJ224 E
	215	40	2,1	2,1	-	335	415	2600	3200	NJ224 EM
	215	40	2,1	2,1	-	335	415	2600	3200	NUP224 E
	215	40	2,1	2,1	-	335	415	2600	3200	NUP224 EM
	215	58	2,1	2,1	4,1	450	610	2600	3200	NU224 E
	215	58	2,1	2,1	-	450	610	2600	3200	NJ224 E
215	58	2,1	2,1	-	450	610	2600	3200	NJ224 EM	
215	58	2,1	2,1	-	450	610	2600	3200	NUP224 E	
215	58	2,1	2,1	-	450	610	2600	3200	NUP224 EM	

## Single row cylindrical roller bearings

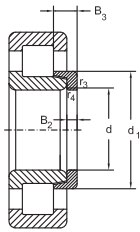

NJ+HJ

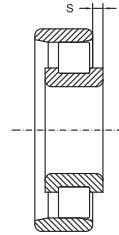
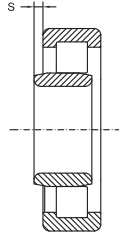

Abutment and fillet dimensions see on page 159

Dimensions							Thrust collar	Mass	
d	E	F	d <sub>1</sub> ≈	D <sub>1</sub> ≈	B <sub>2</sub>	B <sub>3</sub>	Designation	Bearing	Thrust collar
mm								kg	
110	-	132,5	141,6	172,4	-	-	-	4,90	-
	-	132,5	141	174	-	-	-	5,50	-
	-	132,5	-	172,4	-	-	-	6,70	-
	-	132,5	-	174	-	-	-	7,40	-
	-	132,5	141,6	172,4	11	19,5	HJ2222 E	6,70	0,65
	-	132,5	142	174	11	19,5	HJ2222 E	7,30	0,65
	-	132,5	141,6	172,4	-	-	-	6,70	-
	211	-	155,9	-	-	-	-	10,50	-
	-	143	-	199,9	-	-	-	10,50	-
	-	143	-	201	-	-	-	11,50	-
	-	143	155,9	199,9	14	22	HJ322 E	10,50	1,2
	-	143	155,9	199,9	-	-	-	10,50	-
	-	143	155	201	-	-	-	11,90	-
	-	143	-	199,9	-	-	-	17	-
	-	143	-	201	-	-	-	19,10	-
	-	143	155,9	199,9	14	26,5	HJ2322 E	17	1,3
-	143	155	201	14	26,5	HJ2322 E	19,40	1,3	
-	143	155,9	199,9	-	-	-	17	-	
-	155	-	219,5	-	-	-	20,80	-	
-	155	171	219,5	17	29,5	HJ422	20,80	2,1	
-	155	171	219,5	-	-	-	20,80	-	
120	-	135	141	158,8	-	-	-	2,60	-
	195,5	-	153,5	-	-	-	-	5,70	-
	-	143,5	-	186,9	-	-	-	5,70	-
	-	143,5	-	187,4	-	-	-	6,40	-
	-	143,5	-	187,4	-	-	-	6,40	-
	-	143,5	153,5	186,9	11	17	HJ224 E	5,70	0,72
	-	143,5	152	187,4	11	17	HJ224 E	6,50	0,72
	-	143,5	153,5	186,9	-	-	-	5,70	-
	-	143,5	-	186,9	-	-	-	8,30	-
	-	143,5	153,5	186,9	11	20	HJ224 E	8,30	0,75
	-	143,5	152	181	11	20	HJ224 E	9,30	0,75
	-	143,5	153,5	186,9	-	-	-	8,30	-



## Single row cylindrical roller bearings

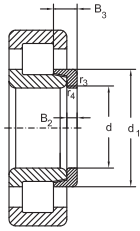

NJ+HJ

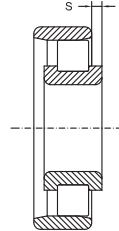
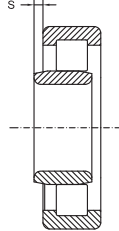

Abutment and fillet dimensions see on page 159

Dimensions							Thrust collar	Mass	
d	E	F	d <sub>1</sub> ≈	D <sub>1</sub> ≈	B <sub>2</sub>	B <sub>3</sub>	Designation	Bearing	Thrust collar
mm								kg	
120	230	-	168,7	-	-	-	-	15,20	-
	-	154	-	217,3	-	-	-	13,40	-
	-	154	-	218,3	-	-	-	14,80	-
	-	154	168,7	217,3	14	22,5	HJ324 E	13,40	1,4
	-	154	168,3	218,3	14	22,5	HJ324 E	14,90	1,4
	-	154	168,7	217,3	-	-	-	13,40	-
	-	154	170	218,3	-	-	-	15,37	-
	-	154	-	217,3	-	-	-	23,50	-
	-	154	168,7	217,3	14	26	HJ2324 E	23,50	1,5
	-	154	168,7	217,3	-	-	-	23,50	-
130	260	-	188	-	-	-	-	29,60	-
	-	170	-	242,5	-	-	-	30,50	-
	-	170	188	242,5	17	30,5	HJ424	30,50	2,7
	-	170	188	240	-	-	-	31,30	-
	-	148	155	175	-	-	-	3,90	-
	-	148	154,8	175,2	8	16	HJ1026	4,20	0,45
	209,5	-	164,2	-	-	-	-	6,50	-
	-	153,5	-	200,2	-	-	-	6,50	-
	-	153,5	-	201,3	-	-	-	7,10	-
	-	153,5	164,2	200,2	11	17	HJ226 E	6,50	0,8
	-	153,5	164	201,3	11	17	HJ226 E	7,29	0,8
	-	153,5	164,2	200,2	-	-	-	6,50	-
	-	153,5	182,3	200,2	-	-	-	10,50	-
	-	153,5	-	193,7	-	-	-	11,48	-
	-	153,5	-	200,2	11	21	HJ2226 E	10,50	0,85
	-	153,5	182,3	200,2	-	-	-	10,50	-
247	-	182,3	-	-	-	-	16,50	-	
-	167	-	233,8	-	-	-	16,50	-	
-	167	-	235	-	-	-	18,50	-	
-	167	182,3	233,8	14	23	HJ326 E	16,50	1,7	
-	167	182,6	235	14	23	HJ326 E	18,65	1,7	
-	167	182,3	233,8	-	-	-	16,50	-	
-	167	182,7	235	-	-	-	20,15	-	



### Single row cylindrical roller bearings

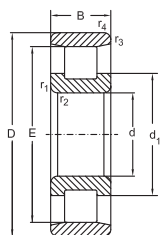

N

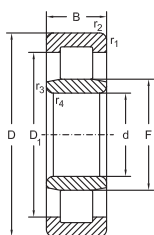

NU

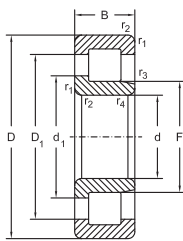

NJ

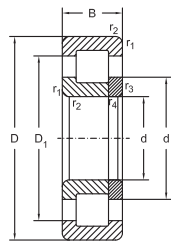

NUP

Dimensions						Basical radial load		Speed limit		Designation
d	D	B	r <sub>1</sub> , r <sub>2</sub> min.	r <sub>3</sub> , r <sub>4</sub> min.	s ≈	dyn. C <sub>r</sub>	stat. C <sub>10</sub>	grease	oil	
mm						kN		min <sup>-1</sup>		
130	280	93	4	4	8,1	915	1220	1900	2400	<b>NU2326 EM</b>
	280	93	4	4	-	915	1220	1900	2400	<b>NJ2326 EM</b>
	280	93	4	4	-	915	1220	1900	2400	<b>NUP2326 EM</b>
	340	78	6	5	6,5	790	960	1800	2200	<b>NU426 M</b>
	340	78	6	5	-	790	960	1800	2200	<b>NJ426 M</b>
140	210	33	2	1,1	4,8	183	265	2800	3400	<b>NU1028 M</b>
	250	42	3	3	3,7	390	510	2400	3000	<b>N228 EM</b>
	250	42	3	3	3,7	390	510	2400	3000	<b>NU228 EM</b>
	250	42	3	3	-	390	510	2400	3000	<b>NJ228 EM</b>
	250	42	3	3	-	390	510	2400	3000	<b>NUP228 EM</b>
	250	68	3	3	4,4	570	830	2200	2800	<b>NU2228 EM</b>
	250	68	3	3	-	570	830	2200	2800	<b>NJ2228 EM</b>
	250	68	3	3	-	570	830	2200	2800	<b>NUP2228 EM</b>
	300	62	4	4	3,7	670	800	1900	2400	<b>N328 E</b>
	300	62	4	4	3,7	670	800	1900	2400	<b>NU328 E</b>
	300	62	4	4	3,7	670	800	1900	2400	<b>NU328 EM</b>
	300	62	4	4	-	670	800	1900	2400	<b>NJ328 E</b>
	300	62	4	4	-	670	800	1900	2400	<b>NJ328 M</b>
	300	62	4	4	-	670	800	1900	2400	<b>NUP328 E</b>
	300	62	4	4	-	670	800	1900	2400	<b>NUP328 EM</b>
	300	102	4	4	9,2	1130	1589	1800	2200	<b>NU2328 EM</b>
	300	102	4	4	-	1130	1589	1800	2200	<b>NJ2328 EM</b>
	300	102	4	4	-	1130	1589	1800	2200	<b>NUP2328 EM</b>
	360	82	6	5	7	850	1020	1600	1900	<b>NU428 M</b>
	360	82	6	5	-	850	1020	1600	1900	<b>NJ428 M</b>
150	225	35	2,1	1,5	4,9	208	310	2600	3200	<b>NU1030 M</b>
	270	45	3	3	4	440	585	2200	2800	<b>N230 EM</b>
	270	45	3	3	4	440	585	2200	2800	<b>NU230 EM</b>
	270	45	3	3	-	440	585	2200	2800	<b>NJ230 EM</b>
	270	45	3	3	-	440	585	2200	2800	<b>NUP230 EM</b>
	270	73	3	3	4,3	655	980	2000	2600	<b>NU2230 EM</b>
	270	73	3	3	-	655	980	2000	2600	<b>NJ2230 EM</b>
	270	73	3	3	-	655	980	2000	2600	<b>NUP2230 EM</b>



## Single row cylindrical roller bearings

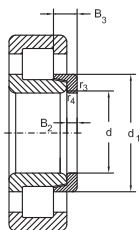

NJ+HJ

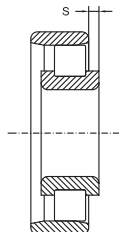
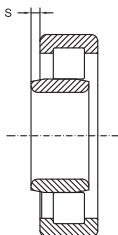

Abutment and fillet dimensions see on page 159

Dimensions							Thrust collar	Mass	
d	E	F	d <sub>1</sub> ≈	D <sub>1</sub> ≈	B <sub>2</sub>	B <sub>3</sub>	Designation	Bearing	Thrust collar
mm							-	kg	
130	-	167	-	233,8	-	-		-	29,60
	-	167	182,3	233,8	14	28	HJ2326 E	29,60	1,8
	-	167	182,3	233,8	-	-	-	29,60	-
	-	185	-	265	-	-	-	42,60	-
	-	185	205	265	18	32	HJ426	42,60	3,4
140	-	158	165	185	-	-	-	4,10	-
	225	-	180	-	-	-	-	9,50	-
	-	169	-	215,3	-	-	-	9,50	-
	-	169	180	215,3	11	18	HJ228 E	9,50	1
	-	169	180	215,3	-	-	-	9,50	-
	-	169	-	215,3	-	-	-	15,50	-
	-	169	180	215,3	11	23	HJ2228 E	15,50	1,1
	-	169	180	215,3	-	-	-	15,50	-
	264	-	195,5	-	-	-	-	22,50	-
	-	180	-	250,3	-	-	-	22,50	-
	-	180	-	251	-	-	-	21,36	-
	-	180	195,5	250,3	15	25	HJ328 E	22,50	2
	-	180	196	251	15	25	HJ328 E	22,21	2
	-	180	195,5	250,3	-	-	-	22,50	-
	-	180	196	251	-	-	-	23,04	-
	-	180	-	250,3	-	-	-	37,20	-
	-	180	195,5	250,3	15	31	HJ2328 E	37,20	2,2
-	180	195,5	250,3	-	-	-	37,20	-	
-	198	-	281	-	-	-	49,50	-	
-	198	219	281	18	33	HJ428	49,50	3,9	
150	-	169,5	176,5	198,1	-	-	-	5	-
	242	-	193,7	-	-	-	-	11,80	-
	-	182	-	231,8	-	-	-	11,80	-
	-	182	193,7	231,8	12	19,5	HJ230 E	11,80	1,3
	-	182	193,7	231,8	-	-	-	11,80	-
	-	182	-	231,8	-	-	-	19,50	-
	-	182	193,7	231,8	12	24,5	HJ2230 E	19,50	1,4
	-	182	193,7	231,8	-	-	-	19,50	-



### Single row cylindrical roller bearings

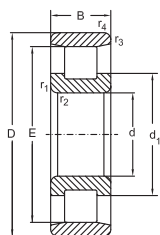

N

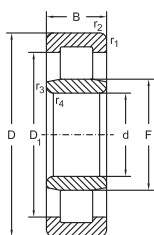

NU

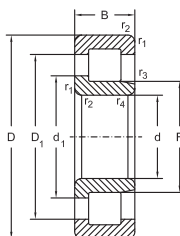

NJ

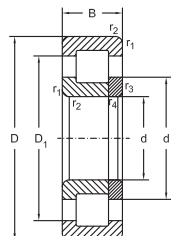

NUP

d	Dimensions					Basical radial load		Speed limit		Designation
	D	B	r <sub>1</sub> , r <sub>2</sub> min.	r <sub>3</sub> , r <sub>4</sub> min.	s ≈	dyn. C <sub>r</sub>	stat. C <sub>10</sub>	grease	oil	
mm										
150	320	65	4	4	4	800	1000	1800	2200	N330 EM
	320	65	4	4	4	800	1000	1800	2200	NU330 EM
	320	65	4	4	-	800	1000	1800	2200	NJ330 EM
	320	65	4	4	-	800	1000	1800	2200	NUP330 EM
	320	108	4	4	9,8	1160	1600	1700	2000	NU2330 EM
	320	108	4	4	-	1160	1600	1700	2000	NJ2330 EM
	320	108	4	4	-	1160	1600	1700	2000	NUP2330 EM
	380	85	6	5	7,5	898	1145	1500	1800	NU430 M
380	85	6	5	-	898	1145	1500	1800	NJ430 M	
160	240	38	2,1	1,5	5,2	245	355	2400	3000	NU1032 M
	240	38	2,1	2,1	-	245	355	2400	3000	NJ1032 M
	290	48	3	3	4,1	500	670	2000	2600	N232 EM
	290	48	3	3	4,1	500	670	2000	2600	NU232 EM
	290	48	3	3	-	500	670	2000	2600	NJ232 EM
	290	48	3	3	-	500	670	2000	2600	NUP232 EM
	290	80	3	3	4,5	800	1180	1900	2400	NU2232 EM
	290	80	3	3	-	800	1180	1900	2400	NJ2232 EM
	290	80	3	3	-	800	1180	1900	2400	NUP2232 EM
	340	68	4	4	4	865	1060	1600	1900	N332 EM
	340	68	4	4	4	865	1060	1600	1900	NU332 EM
	340	68	4	4	-	865	1060	1600	1900	NJ332 EM
	340	68	4	4	-	865	1060	1600	1900	NUP332 EM
	340	114	4	4	10	1320	1830	1600	1900	NU2332 EM
	340	114	4	4	-	1320	1830	1600	1900	NJ2332 EM
	340	114	4	4	-	1320	1830	1600	1900	NUP2332 EM
170	260	42	2,1	2,1	5,8	300	430	2200	2800	NU1034 M
	260	42	2,1	2,1	-	300	430	2200	2800	NJ1034 M
	310	52	4	4	4,2	618	828	1800	2200	NU234 EM6
	310	52	4	4	-	618	828	1800	2200	NJ234 EM6
	310	52	4	4	-	618	828	1800	2200	NUP234 EM6
	310	86	4	4	4,2	950	1400	1700	2000	NU2234 EM
	310	86	4	4	-	950	1400	1700	2000	NJ2234 EM
	310	86	4	4	-	950	1400	1700	2000	NUP2234 EM

## Single row cylindrical roller bearings

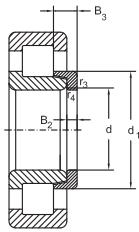

NJ+HJ

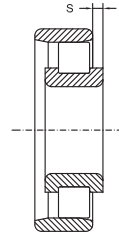
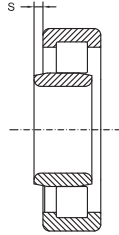

Abutment and fillet dimensions see on page 159

Dimensions							Thrust collar	Mass	
d	E	F	$d_1$ ≈	$D_1$ ≈	$B_2$	$B_3$	Designation	Bearing	Thrust collar
mm								kg	
150	283	-	210,1	-	-	-	-	27,50	-
	-	193	-	268,4	-	-	-	27,50	-
	-	193	210,1	268,4	15	25	HJ330 E	27,50	2,4
	-	193	210,1	268,4	-	-	-	27,50	-
	-	193	-	268,4	-	-	-	44,80	-
	-	193	210,1	268,4	15	31,5	HJ2330 E	44,80	2,5
	-	193	210,1	268,4	-	-	-	44,80	-
160	-	213	-	296	-	-	-	48	-
	-	213	234	296	20	36,5	HJ430	48	4,9
	-	180	188	211,7	-	-	-	6,20	-
	-	180	188	210,3	10	19	HJ1032	6	0,75
	259	-	207,4	-	-	-	-	14,60	-
	-	195	-	248,2	-	-	-	14,60	-
	-	195	207,4	248,2	12	20	HJ232 E	14,60	1,5
	-	195	207,4	248,2	-	-	-	14,60	-
	-	193	-	249,7	-	-	-	24,50	-
	-	193	206,1	249,7	12	24,5	HJ2232 E	24,50	1,6
	-	193	206,1	249,7	-	-	-	24,50	-
	300	-	222,2	-	-	-	-	32,30	-
	-	204	-	284,6	-	-	-	32,30	-
	-	204	222,2	284,6	15	25	HJ332 E	32,10	2,7
-	204	222,2	284,6	-	-	-	32,10	-	
170	-	204	-	284,6	-	-	-	53,50	-
	-	204	222,2	284,6	15	32	HJ2332 E	53,50	2,9
	-	204	222,2	284,6	-	-	-	53,50	-
	-	193	200,9	227,7	-	-	-	8,40	-
	-	193	201,8	227,3	11	21	HJ1034	8,74	1
	-	207	-	267,1	-	-	-	18,20	-
	-	207	220,8	267,1	12	20	HJ234 E	18,20	1,7
	-	207	220,8	267,1	-	-	-	18,20	-
	-	205	-	268,5	-	-	-	29,80	-
	-	205	219,6	268,5	12	24	HJ2234 E	29,80	1,8
	-	205	219,6	268,5	-	-	-	29,80	-



### Single row cylindrical roller bearings

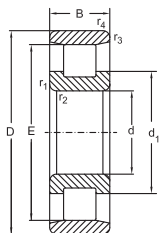

N

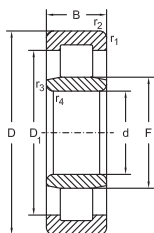

NU

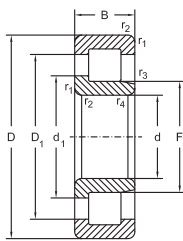

NJ

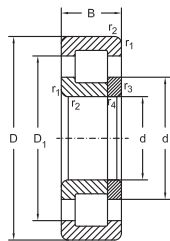

NUP

Dimensions						Basical radial load		Speed limit		Designation
d	D	B	r <sub>1</sub> , r <sub>2</sub> min.	r <sub>3</sub> , r <sub>4</sub> min.	s ≈	dyn. C <sub>r</sub>	stat. C <sub>10</sub>	grease	oil	
mm						kN		min <sup>-1</sup>		
170	360	72	4	4	4,3	800	1020	1600	1900	N334 EM
	360	72	4	4	4,3	928	1150	1600	1900	NU334 EM
	360	72	4	4	-	928	1150	1600	1900	NJ334 EM
	360	72	4	4	-	928	1150	1600	1900	NUP334 EM
	360	120	4	4	10	1220	1760	1500	1800	NU2334 M
	360	120	4	4	-	1220	1760	1500	1800	NJ2334 M
180	280	46	2,1	2,1	6,1	360	520	2200	2800	N1036 M
	280	46	2,1	2,1	6,1	360	520	2200	2800	NU1036 M
	280	46	2,1	2,1	-	360	520	2200	2800	NJ1036 M
	320	52	4	4	4,5	610	830	1800	2200	N236 EM
	320	52	4	4	4,5	610	830	1800	2200	NU236 EM
	320	52	4	4	-	610	830	1800	2200	NJ236 EM
	320	52	4	4	-	610	830	1800	2200	NUP236 EM
	320	86	4	4	4,2	1000	1500	1700	2000	NU2236 EM
	320	86	4	4	-	1000	1500	1700	2000	NJ2236 EM
	320	86	4	4	-	1000	1500	1700	2000	NUP2236 EM
	380	75	4	4	4,4	900	1160	1500	1800	N336 M
	380	75	4	4	4,4	900	1160	1500	1800	NU336 M
	380	75	4	4	-	900	1160	1500	1800	NJ336 M
	380	75	4	4	-	900	1160	1500	1800	NUP336 M
	380	126	4	4	10,5	1370	2000	1400	1700	NU2336 M
	380	126	4	4	-	1370	2000	1400	1700	NJ2336 M
380	126	4	4	-	1370	2000	1400	1700	NUP2336 M	
190	290	46	2,1	2,1	6,2	365	550	2000	2600	NU1038 M
	340	55	4	4	4,7	680	930	1700	2000	N238 EM
	340	55	4	4	4,7	680	930	1700	2000	NU238 EM
	340	55	4	4	-	680	930	1700	2000	NJ238 EM
	340	55	4	4	-	680	930	1700	2000	NUP238 EM
	340	92	4	4	5	854	1338	1600	1900	NU2238 M
	340	92	4	4	-	854	1338	1600	1900	NJ2238 M
	400	78	5	5	4,5	1236	1635	1400	1700	NU338 EM
400	78	5	5	-	1236	1635	1400	1700	NJ338 EM	

## Single row cylindrical roller bearings

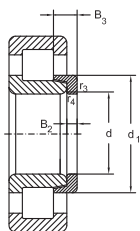

NJ+HJ

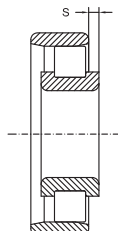
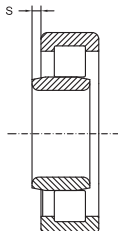

Abutment and fillet dimensions see on page 159

Dimensions							Thrust collar	Mass	
d	E	F	d <sub>1</sub> ≈	D <sub>1</sub> ≈	B <sub>2</sub>	B <sub>3</sub>	Designation	Bearing	Thrust collar
mm								kg	
170	310	-	238	-	-	-	-	38	-
	-	220	-	292,5	-	-	-	38	-
	-	220	238	292,5	16	29,5	HJ334 E	38	3,3
	-	220	238	292,5	-	-	-	38	-
	-	220	-	292,5	-	-	-	63,50	-
	-	220	238	292,5	16	38,5	HJ2334 E	63,50	3,7
180	-	220	238	292,5	-	-	-	63,50	-
	255	-	215	-	-	-	-	10,28	-
	-	205	214,1	244,7	-	-	-	10,90	-
	-	205	215	244	12	22,5	HJ1036	10,50	1,3
	289	-	230,2	-	-	-	-	18,90	-
	-	217	-	277,2	-	-	-	18,90	-
	-	217	230,2	277,2	12	20	HJ236 E	19	1,8
	-	217	230,2	277,2	-	-	-	19	-
	-	215	-	278,6	-	-	-	31,20	-
	-	215	229,6	278,6	12	24	HJ2236 E	31,20	1,9
	-	215	229,6	278,6	-	-	-	31,20	-
	328	-	252	-	-	-	-	44	-
	-	232	-	308,5	-	-	-	44	-
	-	232	252	308,5	17	30,5	HJ336 E	44	3,9
-	232	252	308,5	-	-	-	44	-	
-	232	-	308,5	-	-	-	74	-	
-	232	252	308,5	17	40	HJ2336 E	74	4,9	
-	232	252	308,5	-	-	-	74	-	
190	-	215	225	254,5	-	-	-	11,40	-
	306	-	244,6	-	-	-	-	22,80	-
	-	230	-	293,6	-	-	-	22,80	-
	-	230	244,6	293,6	13	21,5	HJ238 E	22,80	2,2
	-	230	244,6	293,6	-	-	-	22,80	-
	-	231	-	285,2	-	-	-	36,70	-
	-	231	246	285,2	13	26,5	HJ2238 E	37,60	2,4
	-	245	-	334,5	-	-	-	50,50	-
-	245	263,5	334,5	18	31	HJ338 E	50,50	4,5	



### Single row cylindrical roller bearings

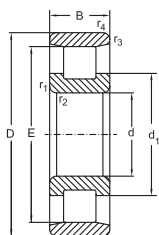

N

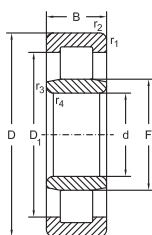

NU

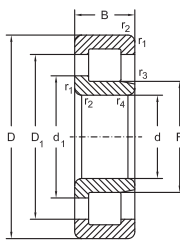

NJ

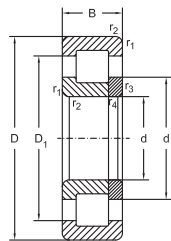

NUP

d	Dimensions					Basical radial load		Speed limit		Designation
	D	B	r <sub>1</sub> , r <sub>2</sub> min.	r <sub>3</sub> , r <sub>4</sub> min.	s ≈	dyn. C <sub>r</sub>	stat. C <sub>10</sub>	grease	oil	
mm										
						kN		min <sup>-1</sup>		
190	400	132	5	5	11	1789	1635	1400	1700	NU2338 EM6
	400	132	5	5	-	1789	2628	1400	1700	NJ2338 EM6
	400	132	5	5	-	1789	2628	1400	1700	NUP2338 EM6
200	310	51	2,1	2,1	7	400	600	2000	2600	NU1040 M
	310	51	2,1	2,1	-	400	600	2200	2800	NUP1040 M
	360	58	4	4	5	750	1040	1600	1900	N240 EM
	360	58	4	4	5	750	1040	1600	1900	NU240 EM
	360	58	4	4	-	750	1040	1600	1900	NJ240 EM
	360	58	4	4	-	750	1040	1600	1900	NUP240 EM
	360	98	4	4	5,1	1220	1860	1500	1800	NU2240 EM
	360	98	4	4	-	1220	1860	1500	1800	NJ2240 EM
	420	80	5	5	5	1300	1695	1400	1700	NU340 EM
	420	80	5	5	-	1300	1695	1400	1700	NJ340 M
	420	138	5	5	11,5	1740	2685	1300	1600	NU2340 M
220	340	56	3	3	7,5	650	1047	1700	2000	NU1044 M
	340	56	5	5	-	650	1047	1700	2000	NJ1044 M
	400	65	4	4	6	778	1113	1500	1800	NU244 M
	400	65	4	4	-	778	1113	1500	1800	NJ244 M
	400	65	4	4	-	778	1113	1500	1800	NUP244 M
	400	108	4	4	6	1370	2310	1400	1700	NU2244 M
	400	108	4	4	-	1370	2310	1400	1700	NJ2244 M
	460	88	5	5	5,2	1230	1650	1300	1600	NU344 M
	460	88	5	5	-	1230	1650	1300	1600	NUP344 M
	460	145	5	5	12	2015	3095	1200	1500	NU2344 E
240	360	56	3	3	7,6	695	1168	1600	1900	NU1048 M
	440	72	4	4	6	936	1339	1400	1700	NU248 M
	440	72	4	4	-	936	1339	1400	1700	NJ248 M
	440	72	4	4	-	936	1339	1400	1700	NUP248 M
	440	120	4	4	7	1430	2320	1300	1600	NU2248 M
	500	95	5	5	5,5	1400	1930	1200	1500	NU348 M
	500	155	5	5	8,5	2080	3150	1600	1900	NU2348 EM
260	400	65	4	4	8	660	1039	1500	1800	NU1052 M

## Single row cylindrical roller bearings

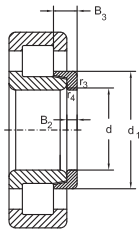

NJ+HJ

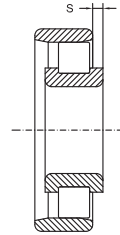
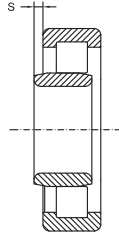

Abutment and fillet dimensions see on page 159

Dimensions							Thrust collar	Mass	
d	E	F	d <sub>1</sub> ≈	D <sub>1</sub> ≈	B <sub>2</sub>	B <sub>3</sub>	Designation	Bearing	Thrust collar
mm								kg	
190	-	245	-	334,5	-	-	-	83,50	-
	-	245	263,5	334,5	18	36,5	HJ2338 E	83,50	5
	-	245	263,5	334,5	-	-	-	85,80	-
200	-	229	239,5	270,1	-	-	-	14,80	-
	-	229	239	270,8	-	-	-	14,90	-
	323	-	258,2	-	-	-	-	26,90	-
	-	243	-	310,1	-	-	-	26,90	-
	-	243	258,2	310,1	14	23	HJ240 E	26,90	2,6
	-	243	258,2	310,1	-	-	-	26,90	-
	-	241	-	311,5	-	-	-	45,70	-
	-	241	256,9	311,5	14	28	HJ240 E	45,70	3
	-	260	-	348	-	-	-	60,80	-
	-	260	280	339,3	18	33	HJ340 E	57,50	5,2
	-	260	-	339,3	-	-	-	99	-
220	-	260	280	339,3	18	44,5	HJ2340 E	99	5,5
	-	250	262	297,3	-	-	-	19,30	-
	-	250	262	298	14	27	HJ1044	19,22	2,2
	-	270	-	334,3	-	-	-	38,10	-
	-	270	285,5	334,3	15	27,5	HJ244 E	38,10	3,6
	-	270	285,5	334,3	-	-	-	38,10	-
	-	270	-	334,3	-	-	-	63,50	-
	-	270	285,5	334,3	15	36,5	HJ2244 E	63,50	3,6
	-	284	-	373,3	-	-	-	75,50	-
240	-	284	307	373,6	-	-	-	77,17	-
	-	284	-	373,3	-	-	-	124	-
	-	270	282	317,3	-	-	-	20,70	2,4
	-	295	-	367,3	-	-	-	51,50	-
	-	295	313	367,3	16	29,5	HJ248 E	51,50	4,65
	-	295	313	366,4	-	-	-	52,13	-
	-	295	-	367,3	-	-	-	85,90	-
260	-	310	-	405,3	-	-	-	96,20	-
	-	299	-	419	-	-	-	148,40	-
	-	296	309,6	349,7	-	-	-	30,80	-



### Single row cylindrical roller bearings

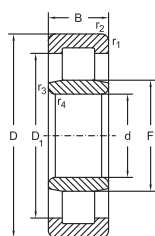

NU

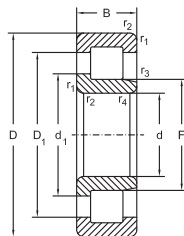

NJ

Dimensions						Basical radial load		Speed limit		Designation	
d	D	B	r <sub>1</sub> , r <sub>2</sub> min.	r <sub>3</sub> , r <sub>4</sub> min.	s ≈	dyn. C <sub>r</sub>	stat. C <sub>10</sub>	grease	oil		
mm						kN		min <sup>-1</sup>			
260	480	80	5	5	6,2	1140	1630	1200	1500	NU252 M	
	480	80	5	5	-	1140	1630	1200	1500	NJ252 M	
	480	130	5	5	7,2	1760	2900	1100	1400	NU2252 M	
	540	102	6	6	6	1600	2200	1100	1400	NU352 M	
	540	165	6	6	9	2320	3550	1000	1300	NU2352 M	
280	420	65	4	4	8,2	680	1100	1400	1700	NU1056 M	
	500	80	5	5	6,2	1120	1660	1200	1500	NU256 M	
	500	80	5	5	-	1120	1660	1200	1500	NJ256 M	
	500	130	5	5	7,2	1760	2900	1100	1400	NU2256 M	
	580	108	6	6	7	1800	2500	1000	1300	NU356 M	
300	460	74	4	4	9,5	900	1430	1300	1600	NU1060 M	
	460	74	4	4	-	900	1430	1300	1600	NJ1060 M	
	540	85	5	5	7,2	1400	2040	1100	1400	NU260 M	
	540	85	5	5	-	1400	2040	1100	1400	NJ260 M	
	540	140	5	5	14	2080	3400	1000	1300	NU2260 M	
	620	109	7,5	7,5	7,2	2080	3000	900	1100	NU360 M	
320	480	74	4	4	9,7	915	1500	1200	1500	NU1064 M	
	580	92	5	5	8,3	1600	2360	1000	1300	NU264 M	
	580	92	5	5	-	1600	2360	1000	1300	NJ264 M	
	440	56	3	3	-	655	1122	1000	1300	NJ1964 M	
340	520	82	5	5	10	1120	1830	1200	1400	NU1068 M	
360	540	82	5	5	10,2	1145	1900	1200	1400	NU1072 M	
380	560	82	5	5	10,6	1180	2000	1000	1300	NU1076 M	
	600	90	5	5	12	1380	2368	950	1200	NU1080 M	
	600	90	5	5	-	1400	2368	950	1200	NUP1080 M	
400	540	65	4	4	13,5	1161	2232	950	1200	NU1980 EM	
	420	620	90	5	5	14	1420	2450	900	1100	NU1084 M
	440	650	94	6	6	14,7	1560	2750	850	1000	NU1088 M
460	680	100	6	6	15,9	1660	3000	850	1000	NU1092 M	
	650	78	5	5	16	1140	2240	900	1100	NU1996 M	
	700	100	5	5	15,9	1680	3080	900	1100	NU1096 M	
500	670	78	5	5	10	1140	2240	850	1000	NU19/500 M	
	720	100	6	6	10,5	1760	3200	800	950	NU10/500 M	



## Single row cylindrical roller bearings

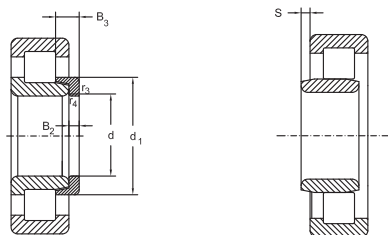

NJ+HJ

Abutment and fillet dimensions see on page 159

Dimensions							Thrust collar	Mass	
d	E	F	d <sub>1</sub> ≈	D <sub>1</sub> ≈	B <sub>2</sub>	B <sub>3</sub>	Designation	Bearing	Thrust collar
mm								kg	
260	-	320	-	399,3	-	-	-	68,30	-
	-	320	340	399,3	18	33	HJ252 E	68,30	6,2
	-	320	-	399,3	-	-	-	112	-
	-	336	-	437,3	-	-	-	120	-
	-	336	-	437,3	-	-	-	195	-
280	-	316	329,6	369,7	-	-	-	32,80	-
	-	340	-	419,3	-	-	-	71,80	-
	-	340	360	419,3	18	33	HJ256 E	71,80	6,5
	-	340	-	419,3	-	-	-	117	-
	-	362	-	469,3	-	-	-	147	-
300	-	340	356	403,6	-	-	-	46,30	-
	-	340	356	403,6	19	36	HJ1060	45,90	5,4
	-	364	-	453,3	-	-	-	89,90	-
	-	364	387	453,3	20	34,5	HJ260 E	89,90	8,4
	-	364	-	453,3	-	-	-	148	-
320	-	388	-	506,7	-	-	-	168	-
	-	360	376	423,1	-	-	-	48,70	-
	-	390	-	485,3	-	-	-	113	-
	-	390	415	485,3	21	37	HJ264 E	113	10,2
	-	348	360	400	19	36	HJ1964	26,10	5,5
340	-	385	403	456	-	-	-	65	-
360	-	405	423	476,4	-	-	-	68,20	-
380	-	425	-	496,7	-	-	-	71,20	-
400	-	450	-	529,5	-	-	-	92,50	-
	-	450	470	530	-	-	-	105,20	-
	-	435	-	495,8	-	-	-	44,02	-
420	-	470	-	549,5	-	-	-	96,20	-
440	-	493	-	575,7	-	-	-	110	-
460	-	516	-	601,5	-	-	-	129	-
480	-	525	-	587	-	-	-	77,50	-
	-	525	-	587	-	-	-	128	-
500	-	545	-	606,8	-	-	-	80,40	-
	-	556	-	641,7	-	-	-	139	-



Single row cylindrical roller bearings

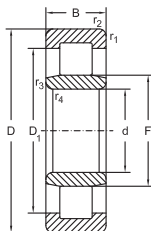

NU

Dimensions						Basic radial load		Speed limit		Designation
d	D	B	r <sub>1</sub> , r <sub>2</sub> min.	r <sub>3</sub> , r <sub>4</sub> min.	s ≈	dyn. C <sub>r</sub>	stat. C <sub>10</sub>	grease	oil	
mm						kN		min <sup>-1</sup>		
<b>560</b>	750	85	5	5	7,5	1600	3200	750	900	<b>NU19/560 M</b>
	820	115	6	6	12,3	2300	4200	630	750	<b>NU10/560 M</b>
<b>600</b>	870	118	6	6	13,9	2750	5050	580	480	<b>NU10/600 M</b>
<b>630</b>	850	100	6	6	8,5	1900	3750	670	800	<b>NU19/630 M</b>
<b>710</b>	950	106	6	6	9,3	2080	4400	600	700	<b>NU19/710 M</b>

## Single row cylindrical roller bearings

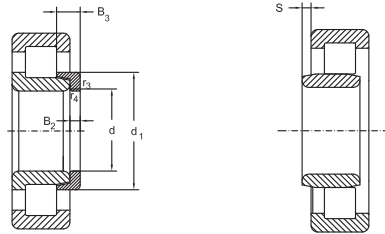

NJ+HJ

Abutment and fillet dimensions see on page 159

Dimensions							Thrust collar	Mass	
d	E	F	$d_1$ ≈	$D_1$ ≈	$B_2$	$B_3$		Bearing	Thrust collar
mm							Designation		
<b>560</b>	-	610	-	679,8	-	-		-	110
	-	626	-	713	-	-	-	215	-
<b>600</b>	-	667	-	779	-	-	-	240	-
<b>630</b>	-	688	-	768,5	-	-	-	169	-
<b>710</b>	-	774	-	860,6	-	-	-	219	-



### Single row full complement cylindrical roller bearings

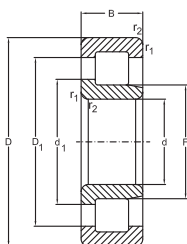

NJ 23..VH

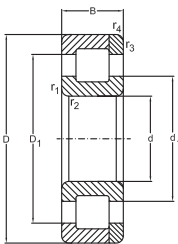

NC

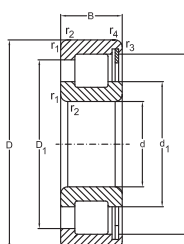

NCF

Dimensions					Basical radial load		Designation
d	D	B	r <sub>1</sub> , r <sub>2</sub> min.	r <sub>3</sub> , r <sub>4</sub> min.	dyn. C <sub>r</sub>	stat. C <sub>or</sub>	
mm					KN		
20	37	11	0,3	0,3	16	18,5	NC2904 V
	37	11	0,3	0,3	16	18,5	NCF2904 V
	42	16	0,6	0,3	33	39,7	NC3004 V
	42	16	0,6	0,3	33	39,7	NCF3004 V
25	42	11	0,3	0,3	18	22,5	NC2905 V
	42	11	0,3	0,3	18	22,5	NCF2905 V
	47	16	0,6	0,3	37,4	46,9	NC3005 V
	47	16	0,6	0,3	37,4	46,9	NCF3005 V
	62	24	1,1	-	68,2	82,8	NJ2305 VH
30	47	11	0,3	0,3	19,8	26	NC2906 V
	47	11	0,3	0,3	19,8	26	NCF2906 V
	55	19	1	0,4	49	63	NC3006 V
	55	19	1	0,4	49	63	NCF3006 V
	72	27	1	-	84	102	NJ2306 VH
35	55	13	0,6	0,3	31	40,5	NC2907 V
	55	13	0,6	0,3	31	40,5	NCF2907 V
	62	20	1	0,4	55	71,5	NC3007 V
	62	20	1	0,4	55	71,5	NCF3007 V
	80	31	1,5	-	108	124	NJ2307 VH
40	62	14	0,6	0,3	34	46,5	NC2908 V
	62	14	0,6	0,3	34	46,5	NCF2908 V
	68	21	1	0,4	66	87,4	NC3008 V
	68	21	1	0,4	65	86	NCF3008 V

## Single row full complement cylindrical roller bearings

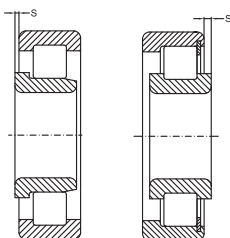

Abutment and fillet dimensions see on page 159

Dimensions					Speed Limit		Mass	Designation
E	F	d <sub>1</sub>	D <sub>1</sub>	s	grease	oil	Bearing	
≈	≈	≈	≈	≈	min <sup>-1</sup>		kg	
mm								
-	-	26,3	30,3	-	4800	9000	0,06	<b>NC2904 V</b>
32,3	-	26,3	30,3	0,5	4800	9000	0,05	<b>NCF2904 V</b>
-	-	27,5	34,5	-	4500	8400	0,12	<b>NC3004 V</b>
37,5	-	27,5	34,5	0,5	4500	8400	0,11	<b>NCF3004 V</b>
-	-	31,4	35,4	-	4000	7500	0,07	<b>NC2905 V</b>
37,45	-	31,4	35,4	0,5	4000	7500	0,06	<b>NCF2905 V</b>
-	-	36,3	49	-	3600	7000	0,13	<b>NC3005 V</b>
42,7	-	36,3	49	0,5	3600	7000	0,12	<b>NCF3005 VH</b>
-	31,71	36,3	49	1,7	3000	5300	0,4	<b>NJ2305 V</b>
-	-	36,5	40,5	-	3600	6700	0,08	<b>NC2906 V</b>
42,5	-	36,5	40,5	0,5	3600	6700	0,07	<b>NCF2906 V</b>
-	-	38,4	46,8	-	3200	5600	0,22	<b>NC3006 V</b>
49,6	-	38,4	46,8	0,8	3200	5600	0,2	<b>NCF3006 V</b>
-	38,34	43,3	56,5	1,8	1900	4000	0,56	<b>NJ2306 VH</b>
-	-	42,4	47,4	-	3000	5600	0,14	<b>NC2907 V</b>
49,9	-	42,4	47,4	0,5	3000	5600	0,12	<b>NCF2907 V</b>
-	-	43,6	52,6	-	2800	5300	0,27	<b>NC3007 V</b>
55,52	-	43,6	52,6	1	2800	5300	0,25	<b>NCF3007 V</b>
-	44,74	50,3	65,8	2	1600	3400	0,73	<b>NJ2307 VH</b>
-	-	48,3	53,9	-	2600	5000	0,16	<b>NC2908 V</b>
56,6	-	48,3	53,9	0,5	2600	5000	0,15	<b>NCF2908 V</b>
-	-	49,1	58,7	-	2400	4500	0,32	<b>NC3008 V</b>
61,8	-	49,1	58,7	1	2400	4500	0,3	<b>NCF3008 V</b>



### Single row full complement cylindrical roller bearings

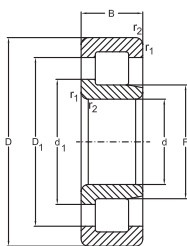

NJ 23..VH

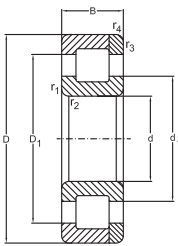

NC

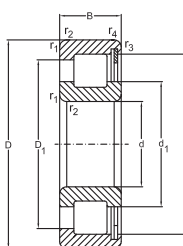

NCF

Dimensions					Basical radial load		Designation
d	D	B	$r_1, r_2$ min.	$r_3, r_4$ min.	dyn. $C_r$	stat. $C_{or}$	
mm					KN		
40	90	33	1,5	-	145	184	NJ2308 VH
45	68	14	0,6	0,3	37	52	NC2909 V
	68	14	0,6	0,3	37	52	NCF2909 V
	75	23	1	0,4	81	110	NC3009 V
	75	23	1	0,4	81	110	NCF3009 V
	100	36	1,5	-	170	220	NJ2309 VH
50	72	14	0,6	0,3	39	56	NC2910 V
	72	14	0,6	0,3	39	56	NCF2910 V
	80	23	1	0,4	86	120	NC3010 V
	80	23	1	0,4	86	120	NCF3010 V
	110	40	2	-	198	250	NJ2310 VH
55	80	16	1	0,6	42	60	NC2911 V
	80	16	1	0,6	42	60	NCF2911 V
	90	26	1,1	0,6	105	152	NC3011 V
	90	26	1,1	0,6	105	152	NCF3011 V
	120	43	2	-	230	260	NJ2311 VH
60	85	16	1	0,6	52	78	NC2912 V
	85	16	1	0,6	52	78	NCF2912 V
	95	26	1,1	0,6	110	160	NC3012 V
	95	26	1,1	0,6	110	160	NCF3012 V
	130	46	2,1	-	260	352	NJ2312 VH
65	90	16	1	0,6	53,5	80	NC2913 V
	90	16	1	0,6	53,5	80	NCF2913 V

## Single row full complement cylindrical roller bearings

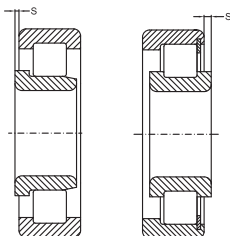

Abutment and fillet dimensions see on page 159

Dimensions					Speed Limit		Mass	Designation
E	F	d <sub>1</sub>	D <sub>1</sub>	s	grease	oil	Bearing	
≈	≈	≈	≈	≈	min <sup>-1</sup>		kg	
mm								
-	51,1	57,5	76	2,4	1400	3000	1	<b>NJ2308 VH</b>
-	-	53,6	59,2	-	2200	4500	0,2	<b>NC2909 V</b>
61,9	-	53,6	59,2	0,5	2200	4500	0,18	<b>NCF2909 V</b>
-	-	55	65	-	2000	4300	0,42	<b>NC3009 V</b>
68,5	-	55	65	1	2000	4300	0,4	<b>NCF3009 V</b>
-	56,13	62,5	81,8	2,4	1300	2800	1,4	<b>NJ2309 VH</b>
-	-	58,7	64,4	-	1900	4000	0,21	<b>NC2910 V</b>
67,1	-	58,7	64,4	0,5	1900	4000	0,18	<b>NCF2910 V</b>
-	-	58	68,8	-	1900	4000	0,45	<b>NC3010 V</b>
72,33	-	58	68,8	1	1900	4000	0,43	<b>NCF3010 V</b>
-	60,7	68,3	90,3	2,6	1600	3200	1,85	<b>NJ2310 VH</b>
-	-	64,2	70,2	-	1800	3800	0,3	<b>NC2911 V</b>
73,2	-	64,2	70,2	0,5	1800	3800	0,27	<b>NCF2911 V</b>
-	-	67,5	79,5	-	1600	3400	0,66	<b>NC3011 V</b>
83,7	-	67,5	79,5	1,2	1600	3400	0,63	<b>NCF3011 V</b>
-	67,1	75,5	98,6	2,6	1000	2200	2,3	<b>NJ2311 VH</b>
-	-	69,5	76,1	-	1600	3400	0,3	<b>NC2912 V</b>
79,3	-	69,5	76,1	0,5	1600	3400	0,28	<b>NCF2912 V</b>
-	-	70,9	82,9	-	1600	3200	0,71	<b>NC3012 V</b>
86,9	-	70,9	82,9	1,2	1600	3200	0,68	<b>NCF3012 V</b>
-	73,68	82,1	106	3	950	2000	2,83	<b>NJ2312 VH</b>
-	-	73,7	80,3	-	1600	3400	0,33	<b>NC2913 V</b>
83,5	-	73,7	80,3	0,5	1600	3400	0,3	<b>NCF2913 V</b>



### Single row full complement cylindrical roller bearings

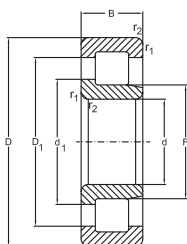

NJ 23..VH

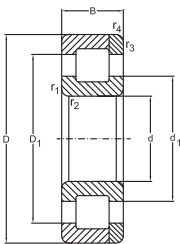

NC

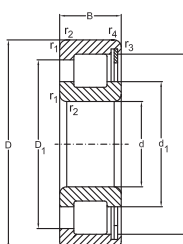

NCF

Dimensions					Basical radial load		Designation
d	D	B	r <sub>1</sub> , r <sub>2</sub> min.	r <sub>3</sub> , r <sub>4</sub> min.	dyn. C <sub>r</sub>	stat. C <sub>or</sub>	
mm					KN		
65	100	26	1,1	0,6	117	175	NC3013 V
	100	26	1,1	0,6	117	175	NCF3013 V
	140	48	2,1	-	302	358	NJ2313 VH
70	100	19	1	0,6	77	118	NC2914 V
	100	19	1	0,6	77	118	NCF2914 V
	110	30	1,1	0,6	145	215	NC3014 V
	110	30	1,1	0,6	145	215	NCF3014 V
	150	51	2,1	-	335	455	NJ2314 VH
75	105	19	1	0,6	79,5	124	NC2915 V
	105	19	1	0,6	79,5	124	NCF2915 V
	115	30	1,1	0,6	154	224	NC3015 V
	115	30	1,1	0,6	154	224	NCF3015 V
	160	55	2,1	-	390	550	NJ2315 VH
80	110	19	1	0,6	81	128	NC2916 V
	110	19	1	0,6	81	128	NCF2916 V
	125	34	1,1	0,6	194	285	NC3016 V
	125	34	1,1	0,6	194	285	NCF3016 V
	170	58	2,1	-	455	550	NJ2316 VH
85	120	22	1,1	1	104	168	NC2917 V
	120	22	1,1	1	105	168	NCF2917 V
	130	34	1,1	0,6	195	295	NC3017 V
	130	34	1,1	0,6	195	295	NCF3017 V
	180	60	3	-	482	695	NJ2317 VH



## Single row full complement cylindrical roller bearings

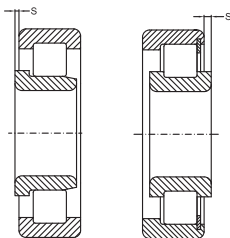

Abutment and fillet dimensions see on page 159

Dimensions					Speed Limit		Mass	Designation
E	F	d <sub>1</sub>	D <sub>1</sub>	s	grease	oil	Bearing	
≈	≈	≈	≈	≈	min <sup>-1</sup>		kg	
mm								
-	-	77,1	87,1	-	1400	3000	0,75	<b>NC3013 V</b>
93,1	-	77,1	87,1	1,2	1400	3000	0,72	<b>NCF3013 V</b>
-	80,71	89,4	117	3	900	1900	3,48	<b>NJ2313 VH</b>
-	-	80,5	88,5	-	1400	3000	0,52	<b>NC2914 V</b>
92,5	-	80,5	88,5	0,75	1400	3000	0,48	<b>NCF2914 V</b>
-	-	82,6	97,2	-	1300	2800	1,1	<b>NC3014 V</b>
102,1	-	82,6	97,2	1,5	1300	2800	1	<b>NCF3014 V</b>
-	84,22	93,8	121	3	850	1800	4,4	<b>NJ2314 VH</b>
-	-	85,6	93,6	-	1300	2800	0,55	<b>NC2915 V</b>
97,6	-	85,6	93,6	0,75	1300	2800	0,5	<b>NCF2915 V</b>
-	-	87	102	-	1200	2600	1,15	<b>NC3015 V</b>
106,5	-	87	102	1,5	1200	2600	1,1	<b>NCF3015 V</b>
-	91,25	100,8	132,5	3	750	1600	5,18	<b>NJ2315 VH</b>
-	-	90,7	98,7	-	1200	2600	0,57	<b>NC2916 V</b>
102,7	-	90,7	98,7	0,75	1200	2600	0,53	<b>NCF2916 V</b>
-	-	94,8	112	-	1100	2400	1,56	<b>NC3016 V</b>
117,2	-	94,8	112	1,8	1100	2400	1,5	<b>NCF3016 V</b>
-	98,3	109	141	4	700	1500	6,4	<b>NJ2316 VH</b>
-	-	99,1	109	-	1100	2400	0,79	<b>NC2917 V</b>
112,5	-	99,1	109	0,75	1100	2400	0,78	<b>NCF2917 V</b>
-	-	99,2	116	-	1100	2400	1,6	<b>NC3017 V</b>
121,6	-	99,2	116	1,8	1100	2200	1,55	<b>NCF3017 V</b>
-	107,02	117,4	151,5	4	900	1800	7,3	<b>NJ2317 VH</b>



### Single row full complement cylindrical roller bearings

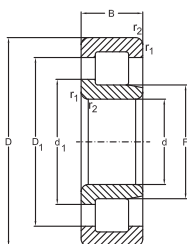

NJ 23..VH

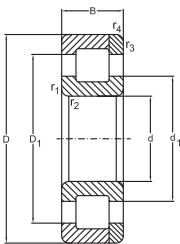

NC

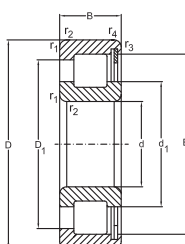

NCF

Dimensions					Basical radial load		Designation
d	D	B	r <sub>1</sub> , r <sub>2</sub> min.	r <sub>3</sub> , r <sub>4</sub> min.	dyn. C <sub>r</sub>	stat. C <sub>or</sub>	
mm					KN		
90	125	22	1,1	1	105	172	NC2918 V
	125	22	1,1	1	105	172	NCF2918 V
	140	37	1,5	1	227	348	NC3018 V
	140	37	1,5	1	227	348	NCF3018 V
	190	64	3	-	520	790	NJ2318 VH
95	130	22	1,1	1	108	180	NC2919 V
	130	22	1,1	1	108	180	NCF2919 V
	145	37	1,5	1	230	360	NC3019 V
	145	37	1,5	1	230	360	NCF3019 V
100	140	24	1,1	1	132	220	NC2920 V
	140	24	1,1	1	132	220	NCF2920 V
	150	37	1,5	1	242	375	NC3020 V
	150	37	1,5	1	242	375	NCF3020 V
	215	73	3	-	704	1030	NJ2320 VH
110	150	24	1,1	1	140	243	NC2922 V
	150	24	1,1	1	140	243	NCF2922 V
	170	45	2	1	325	510	NC3022 V
	170	45	2	1	325	510	NCF3022 V
	240	80	3	-	830	1060	NJ2322 VH
120	165	27	1,1	1	172	287	NC2924 V
	165	27	1,1	1	172	287	NCF2924 V
	180	46	2	1	340	550	NC3024 V
	180	46	2	1	340	550	NCF3024 V

## Single row full complement cylindrical roller bearings

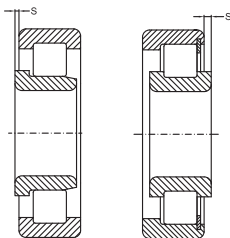

Abutment and fillet dimensions see on page 159

Dimensions					Speed Limit		Mass	Designation
E	F	d <sub>1</sub>	D <sub>1</sub>	s	grease	oil	Bearing	
≈	≈	≈	≈	≈	min <sup>-1</sup>		kg	
mm								
-	-	102	111	-	1100	2400	0,9	<b>NC2918 V</b>
115,6	-	102	111	0,75	1100	2400	0,82	<b>NCF2918 V</b>
-	-	106,2	125	-	1000	2200	2,12	<b>NC3018 V</b>
130,3	-	106,2	125	2	1000	2200	2,05	<b>NCF3018 V</b>
-	108,8	121	156	4	670	1400	8,75	<b>NJ2318 VH</b>
-	-	107	117	-	1000	2200	0,94	<b>NC2919 V</b>
120,4	-	107	117	0,75	1000	2200	0,86	<b>NCF2919 V</b>
-	-	111	129	2	950	2000	2,28	<b>NC3019 V</b>
135,1	-	111	129	4,5	950	2000	2,15	<b>NCF3019 V</b>
-	-	114	124	-	1000	2200	1,25	<b>NC2920 V</b>
129	-	114	124	0,75	1000	2200	1,15	<b>NCF2920 V</b>
-	-	116	134	-	950	2000	2,29	<b>NC3020 V</b>
139,9	-	116	134	2	950	2000	2,2	<b>NCF3020 V</b>
-	122,8	136	176	4,5	600	1200	13	<b>NJ2320 VH</b>
-	-	126	137	-	900	1900	1,35	<b>NC2922 V</b>
141,3	-	126	137	0,75	900	1900	1,25	<b>NCF2922 V</b>
-	-	129	150	-	900	1800	3,79	<b>NC3022 V</b>
157	-	129	150	3	900	1800	3,65	<b>NCF3022 V</b>
-	133,35	147	194,2	5	700	1400	17,7	<b>NJ2322 VH</b>
-	-	136	149	-	850	1800	1,88	<b>NC2924 V</b>
154,3	-	136	149	0,75	850	1800	1,7	<b>NCF2924 V</b>
-	-	139	160,5	-	800	1700	4,1	<b>NC3024 V</b>
167,9	-	139	160,5	3,5	800	1700	3,95	<b>NCF3024 V</b>



**Single row full complement cylindrical roller bearings**

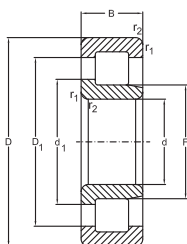

NJ 23..VH

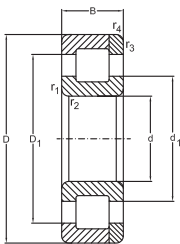

NC

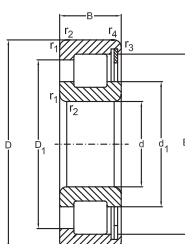

NCF

Dimensions					Basical radial load		Designation
d	D	B	r <sub>1</sub> , r <sub>2</sub> min.	r <sub>3</sub> , r <sub>4</sub> min.	dyn. C <sub>r</sub>	stat. C <sub>or</sub>	
mm					KN		
<b>120</b>	260	86	3	-	920	1300	<b>NJ2324 VH</b>
<b>130</b>	180	30	1,5	1,1	205	350	<b>NC2926 V</b>
	180	30	1,5	1,1	205	350	<b>NCF2926 V</b>
	200	52	2	1	415	620	<b>NC3026 V</b>
	200	52	2	1	415	620	<b>NCF3026 V</b>
	280	93	4	-	1080	1660	<b>NJ2326 VH</b>
<b>140</b>	190	30	1,5	1,1	220	375	<b>NC2928 V</b>
	190	30	1,5	1,1	220	375	<b>NCF2928 V</b>
	210	53	2	1	440	680	<b>NC3028 V</b>
	210	53	2	1	440	680	<b>NCF3028 V</b>
	300	102	4	-	1250	1910	<b>NJ2328 VH</b>
<b>150</b>	190	20	1	1,1	108	185	<b>NC1830 V</b>
	190	20	1	1,1	108	185	<b>NCF1830 V</b>
	210	36	2	1,1	286	497	<b>NC2930 V</b>
	210	36	2	1,1	286	497	<b>NCF2930 V</b>
	225	56	2,1	1,1	530	880	<b>NC3030 V</b>
	225	56	2,1	1,1	530	880	<b>NCF3030 V</b>
	320	108	4	-	1450	2240	<b>NJ2330 VH</b>
<b>160</b>	200	20	1,1	1,1	112	199	<b>NC1832 V</b>
	200	20	1,1	1,1	112	199	<b>NCF1832 V</b>
	220	36	2	1,1	297	524	<b>NC2932 V</b>
	220	36	2	1,1	297	524	<b>NCF2932 V</b>
	240	60	2,1	1,1	580	970	<b>NC3032 V</b>

## Single row full complement cylindrical roller bearings

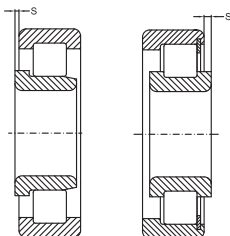

Abutment and fillet dimensions see on page 159

Dimensions					Speed Limit		Mass	Designation
E	F	d <sub>1</sub>	D <sub>1</sub>	s	grease	oil	Bearing	
≈	≈	≈	≈	≈	min <sup>-1</sup>		kg	
mm								
-	147,7	164	211	5,5	530	1000	22,3	<b>NJ2324 VH</b>
-	-	147	161	-	750	1600	2,5	<b>NC2926 V</b>
167,1	-	147	161	0,75	750	1600	2,3	<b>NCF2926 V</b>
-	-	148,6	175	-	700	1500	6	<b>NC3026 V</b>
186,5	-	148,6	175	3,5	700	1500	5,8	<b>NCF3026 V</b>
-	157,95	174,1	229,6	6	500	950	28	<b>NJ2326 VH</b>
-	-	159	173	-	700	1500	2,59	<b>NC2928 V</b>
180	-	159	173	0,75	700	1500	2,4	<b>NCF2928 V</b>
-	-	162,7	189,1	-	670	1400	6,21	<b>NC3028 V</b>
198,2	-	162,7	189,1	3,5	670	1400	6,1	<b>NCF3028 V</b>
-	168,5	184,7	245,3	6,5	450	850	35,5	<b>NJ2328 VH</b>
-	-	163	176	1,5	700	1500	1,54	<b>NC1830 V</b>
159,5	-	163	176	1,5	700	1500	1,3	<b>NCF1830 V</b>
-	-	171	188	-	670	1400	4	<b>NC2930 V</b>
195,5	-	171	188	0,8	670	1400	3,8	<b>NCF2930 V</b>
-	-	174	203	-	630	1300	7,72	<b>NC3030 V</b>
211,7	-	174	203	3,5	630	1300	7,5	<b>NCF3030 V</b>
-	182,5	203	261	6,5	430	800	42,5	<b>NJ2330 VH</b>
-	-	173	185	1,5	670	1400	1,6	<b>NC1832 V</b>
169	-	173	185	1,5	670	1400	1,45	<b>NCF1832 V</b>
-	-	181	198	-	630	1300	4	<b>NC2932 V</b>
205,7	-	181	198	0,8	630	1300	4,05	<b>NCF2932 V</b>
-	-	184,8	214,8	-	600	1100	9,26	<b>NC3032 V</b>



### Single row full complement cylindrical roller bearings

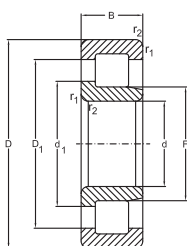

NJ 23..VH

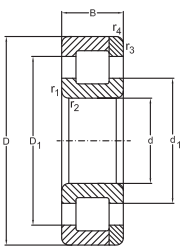

NC

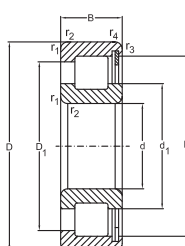

NCF

Dimensions					Basical radial load		Designation
d	D	B	r <sub>1</sub> , r <sub>2</sub> min.	r <sub>3</sub> , r <sub>4</sub> min.	dyn. C <sub>r</sub>	stat. C <sub>or</sub>	
mm					KN		
160	240	60	2,1	1,1	580	970	NCF3032 V
	340	114	4	-	1630	2550	NJ2332 VH
170	215	22	1,1	1,1	142	245	NC1834 V
	215	22	1,1	1,1	142	245	NCF1834 V
	230	36	2	1,1	308	552	NC2934 V
	230	36	2	1,1	308	552	NCF2934 V
	260	67	2,1	1,1	728	1230	NC3034 V
	260	67	2,1	1,1	728	1230	NCF3034 V
	360	120	3	-	1760	2400	NJ2334 VH
180	225	22	1,1	1,1	147	275	NC1836 V
	225	22	1,1	1,1	147	275	NCF1836 V
	250	42	2	1,1	391	690	NC2936 V
	250	42	2	1,1	391	690	NCF2936 V
	280	74	2,1	2,1	820	1400	NC3036 V
	280	74	2,1	2,1	820	1400	NCF3036 V
	300	126	4	-	1900	2700	NJ2336 VH
190	240	24	1,5	1,5	172	320	NC1838 V
	240	24	1,5	1,5	172	320	NCF1838 V
	260	42	2	1,1	440	782	NC2938 V
	260	42	2	1,1	440	782	NCF2938 V
	290	75	2,1	2,1	850	1450	NC3038 V
	290	75	2,1	2,1	850	1450	NCF3038 V
	400	132	4	-	2080	2900	NJ2338 VH

## Single row full complement cylindrical roller bearings

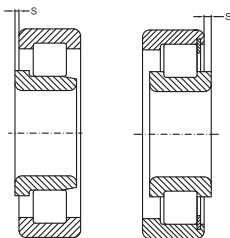

Abutment and fillet dimensions see on page 159

Dimensions					Speed Limit		Mass	Designation
E	F	d <sub>1</sub>	D <sub>1</sub>	s	grease	oil	Bearing	
≈	≈	≈	≈	≈	min <sup>-1</sup>		kg	
mm								
225,1	-	184,8	214,8	4	600	1100	9,1	<b>NCF3032 V</b>
-	196,55	216,7	286	7	400	750	48,8	<b>NJ2332 VH</b>
-	-	185	200	1,5	630	1300	2	<b>NC1834 V</b>
204,5	-	185	200	1,5	630	1300	1,85	<b>NCF1834 V</b>
-	-	192	208	-	600	1200	4,5	<b>NC2934 V</b>
216	-	192	208	0,8	600	1200	4,25	<b>NCF2934 V</b>
-	-	198	232	-	560	1000	13,7	<b>NC3034 V</b>
243,2	-	198	232	4	560	1000	12,1	<b>NCF3034 V</b>
-	203,56	224,5	296,4	7	450	800	59,2	<b>NJ2334 VH</b>
-	-	196	211	1,5	600	1200	2,2	<b>NC1836 V</b>
215,2	-	196	211	1,5	600	1200	1,95	<b>NCF1836 V</b>
-	-	203	223	-	560	1100	6,4	<b>NC2936 V</b>
232	-	203	223	1	560	1100	6,6	<b>NCF2936 V</b>
-	-	212	249	-	560	1100	17,1	<b>NC3036 V</b>
260,5	-	212	249	5	560	1100	16,5	<b>NCF3036 V</b>
-	221,74	242,6	314,6	9	400	700	69,6	<b>NJ2336 VH</b>
-	-	208	224	1,8	560	1100	2,7	<b>NC1838 V</b>
229	-	208	224	1,8	560	1100	2,45	<b>NCF1838 V</b>
-	-	212	236	-	560	1100	6,8	<b>NC2938 V</b>
244	-	212	236	1	560	1100	6,5	<b>NCF2938 V</b>
-	-	222	258	-	530	1000	17,9	<b>NC3038 V</b>
270	-	222	258	6	530	1000	17	<b>NCF3038 V</b>
-	224,6	247,6	327	7	400	700	80	<b>NJ2338 VH</b>



### Single row full complement cylindrical roller bearings

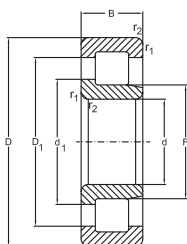

NJ 23..VH

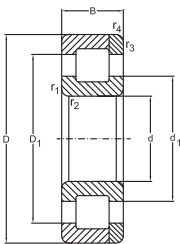

NC

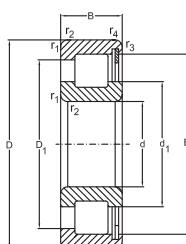

NCF

Dimensions					Basical radial load		Designation
d	D	B	r <sub>1</sub> , r <sub>2</sub> min.	r <sub>3</sub> , r <sub>4</sub> min.	dyn. C <sub>r</sub>	stat. C <sub>or</sub>	
mm					KN		
200	250	24	1,5	1,5	176	335	NC1840 V
	250	24	1,5	1,5	176	335	NCF1840 V
	280	48	2,1	1,5	528	938	NC2940 V
	280	48	2,1	1,5	528	938	NCF2940 V
	310	82	2,1	2,1	990	1750	NC3040 V
	310	82	2,1	2,1	990	1750	NCF3040 V
	420	138	5	-	2290	3680	NJ2340 VH
220	270	24	1,5	1,5	183	350	NC1844 V
	270	24	1,5	1,5	183	350	NCF1844 V
	300	48	2,1	1,5	550	1030	NC2944 V
	300	48	2,1	1,5	550	1030	NCF2944 V
	340	90	3	3	1190	2100	NC3044 V
	340	90	3	3	1190	2100	NCF3044 V
240	300	28	2	2	260	510	NC1848 V
	300	28	2	2	260	510	NCF1848 V
	320	48	2,1	1,5	583	1120	NC2948 V
	320	48	2,1	1,5	583	1120	NCF2948 V
	360	92	3	3	1250	2240	NC3048 V
	360	92	3	3	1250	2240	NCF3048 V
260	320	28	2	2	270	550	NC1852 V
	320	28	2	2	270	550	NCF1852 V
	360	60	2,1	1,5	737	1410	NC2952 V
	360	60	2,1	1,5	737	1410	NCF2952 V



## Single row full complement cylindrical roller bearings

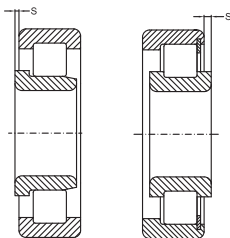

Abutment and fillet dimensions see on page 159

Dimensions					Speed Limit		Mass	Designation
E	F	d <sub>1</sub>	D <sub>1</sub>	s	grease	oil	Bearing	
≈	≈	≈	≈	≈	min <sup>-1</sup>		kg	
mm								
-	-	216	233	1,8	560	1100	3	<b>NC1840 V</b>
237,5	-	216	233	1,8	560	1100	2,6	<b>NCF1840 V</b>
-	-	227	253	-	530	1000	9,5	<b>NC2940 V</b>
262	-	227	253	3	530	1000	9,1	<b>NCF2940 V</b>
-	-	227	276	-	450	800	23	<b>NC3040 V</b>
287,75	-	227	276	6,5	450	800	22,5	<b>NCF3040 V</b>
-	238,65	263,2	347,5	9	320	600	91,6	<b>NJ2340 VH</b>
-	-	237	253	1,8	530	1000	3,35	<b>NC1844 V</b>
258	-	237	253	1,8	530	1000	2,85	<b>NCF1844 V</b>
-	-	248	274	-	480	900	10,9	<b>NC2944 V</b>
283	-	248	274	2,5	480	900	10,2	<b>NCF2944 V</b>
-	-	254,7	297,9	-	430	850	30,5	<b>NC3044 V</b>
312,7	-	254,7	297,9	7	430	850	29,5	<b>NCF3044 V</b>
-	-	261	281	1,8	480	900	5,3	<b>NC1848 V</b>
287	-	261	281	1,8	480	900	4,4	<b>NCF1848 V</b>
-	-	261	296	-	450	850	12	<b>NC2948 V</b>
303	-	261	296	2,5	450	850	11	<b>NCF2948 V</b>
-	-	278	322	-	430	800	33	<b>NC3048 V</b>
335,6	-	278	322	7	430	800	32	<b>NCF3048 V</b>
-	-	281	301	1,8	430	800	5,55	<b>NC1852 V</b>
307,2	-	281	301	1,8	430	800	4,75	<b>NCF1852 V</b>
-	-	294	321	-	400	750	19,3	<b>NC2952 V</b>
333,7	-	294	321	5	400	750	18,5	<b>NCF2952 V</b>



### Single row full complement cylindrical roller bearings

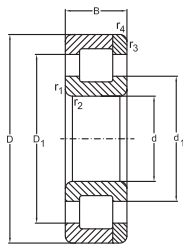

NC

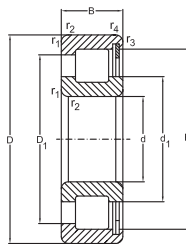

NCF

Dimensions					Basical radial load		Designation
d	D	B	r <sub>1</sub> , r <sub>2</sub> min.	r <sub>3</sub> , r <sub>4</sub> min.	dyn. C <sub>r</sub>	stat. C <sub>or</sub>	
mm					KN		
260	400	104	4	4	1600	2920	NC3052 V
	400	104	4	4	1600	2920	NCF3052 V
280	350	33	2	2	330	650	NC1856 V
	350	33	2	2	330	650	NCF1856 V
	380	60	2,1	1,5	897	1710	NC2956 V
	380	60	2,1	1,5	897	1710	NCF2956 V
	420	106	4	4	1650	3100	NC3056 V
	420	106	4	4	1650	3100	NCF3056 V
300	380	38	2,1	2,1	418	850	NC1860 V
	380	38	2,1	2,1	418	850	NCF1860 V
	420	72	3	3	1120	2170	NC2960 V
	420	72	3	3	1120	2170	NCF2960 V
320	400	38	2,1	2,1	440	852	NC1864 V
	400	38	2,1	2,1	440	852	NCF1864 V
	440	72	3	3	1140	2300	NC2964 V
	440	72	3	3	1140	2300	NCF2964 V
340	420	38	2,1	2,1	446	900	NC1868 V
	420	38	2,1	2,1	446	900	NCF1868 V
	460	72	3	3	1190	2430	NC2968 V
	460	72	3	3	1190	2430	NCF2968 V
360	440	38	2,1	2,1	452	950	NC1872 V
	440	38	2,1	2,1	452	950	NCF1872 V
	480	72	3	3	1230	2580	NC2972 V

## Single row full complement cylindrical roller bearings

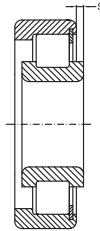

Abutment and fillet dimensions see on page 159

Dimensions					Speed Limit		Mass	Designation
E	F	d <sub>1</sub>	D <sub>1</sub>	s	grease	oil	Bearing	
≈	≈	≈	≈	≈	min <sup>-1</sup>		kg	
mm								
-	-	304,1	358,1	-	380	700	47,5	<b>NC3052 V</b>
373,5	-	304,1	358,1	8	380	700	46,5	<b>NCF3052 V</b>
-	-	305	327	2,5	400	750	8	<b>NC1856 V</b>
334	-	305	327	2,5	400	750	7,1	<b>NCF1856 V</b>
-	-	305	346	-	380	700	21,1	<b>NC2956 V</b>
362,7	-	319	346	4	380	700	20	<b>NCF2956 V</b>
-	-	324	375	-	320	560	52,5	<b>NC3056 V</b>
391	-	324	375	9	320	560	50	<b>NCF3056 V</b>
-	-	329	355	3	360	670	11,5	<b>NC1860 V</b>
363	-	329	355	3	360	670	10	<b>NCF1860 V</b>
-	-	342	375	-	340	630	32,3	<b>NC2960 V</b>
390,5	-	342	375	5	340	630	31,5	<b>NCF2960 V</b>
-	-	349	375	3	340	630	11,3	<b>NC1864 V</b>
383	-	349	375	3	340	630	10,5	<b>NCF1864 V</b>
-	-	363	395	-	320	600	34	<b>NC2964 V</b>
411	-	363	395	5	320	600	33	<b>NCF2964 V</b>
-	-	369	395	3	320	600	12,8	<b>NC1868 V</b>
403	-	369	395	3	320	600	11	<b>NCF1868 V</b>
-	-	383	415	-	300	560	36	<b>NC2968 V</b>
431	-	383	415	3	300	560	35	<b>NCF2968 V</b>
-	-	389	415	3	300	560	12,4	<b>NC1872 V</b>
423,3	-	389	415	3	300	560	12	<b>NCF1872 V</b>
-	-	403	436	-	280	530	36,8	<b>NC2972 V</b>



### Single row full complement cylindrical roller bearings

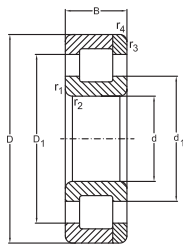

NC

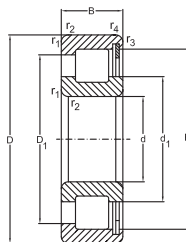

NCF

Dimensions					Basical radial load		Designation
d	D	B	r <sub>1</sub> , r <sub>2</sub> min.	r <sub>3</sub> , r <sub>4</sub> min.	dyn. C <sub>r</sub>	stat. C <sub>or</sub>	
mm					KN		
<b>360</b>	480	72	3	3	1230	2580	<b>NCF2972 V</b>
<b>380</b>	480	46	2,1	2,1	627	1230	<b>NC1876 V</b>
	480	46	2,1	2,1	627	1230	<b>NCF1876 V</b>
	520	82	4	4	1570	3000	<b>NC2976 V</b>
	520	82	4	4	1570	3000	<b>NCF2976 V</b>
<b>400</b>	500	46	2,1	2,1	627	1280	<b>NC1880 V</b>
	500	46	2,1	2,1	627	1280	<b>NCF1880 V</b>
	540	82	4	4	1650	3420	<b>NC2980 V</b>
	540	82	4	4	1650	3420	<b>NCF2980 V</b>
<b>420</b>	520	46	2,1	2,1	660	1340	<b>NC1884 V</b>
	520	46	2,1	2,1	660	1340	<b>NCF1884 V</b>
	520	60	2,1	2,1	945,6	2329	<b>NCF2884 V</b>
	560	82	4	4	1680	3500	<b>NC2984 V</b>
	560	82	4	4	1680	3500	<b>NCF2984 V</b>
	<b>440</b>	540	46	2,1	2,1	670	1405
540		46	2,1	2,1	670	1405	<b>NCF1888 V</b>
600		95	4	4	2010	4270	<b>NC2988 V</b>
600		95	4	4	2010	4270	<b>NCF2988 V</b>
<b>460</b>	580	56	3	3	913	1850	<b>NC1892 V</b>
	580	56	3	3	913	1850	<b>NCF1892 V</b>
	620	95	4	4	2050	4420	<b>NC2992 V</b>
	620	95	4	4	2050	4420	<b>NCF2992 V</b>
<b>480</b>	600	56	3	3	935	1920	<b>NCF1896 V</b>

## Single row full complement cylindrical roller bearings

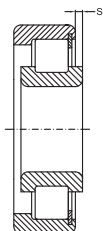

Abutment and fillet dimensions see on page 159

Dimensions					Speed Limit		Mass	Designation
E	F	d <sub>1</sub>	D <sub>1</sub>	s	grease	oil	Bearing	
≈	≈	≈	≈	≈	min <sup>-1</sup>		kg	
mm								
451,5	-	403	436	5	280	530	36,5	<b>NCF2972 V</b>
-	-	416	448	3,5	280	530	19,9	<b>NC1876 V</b>
458	-	416	448	3,5	280	530	19,5	<b>NCF1876 V</b>
-	-	427	473	-	260	500	53,5	<b>NC2976 V</b>
488	-	427	473	5	260	500	52,5	<b>NCF2976 V</b>
-	-	433	465	3,5	260	500	21,2	<b>NC1880 V</b>
475	-	433	465	3,5	260	500	20,5	<b>NCF1880 V</b>
-	-	450	496	-	240	480	55	<b>NC2980 V</b>
511	-	450	496	5	240	480	54,5	<b>NCF2980 V</b>
-	-	457	489	3,5	240	480	21,6	<b>NC1884 V</b>
499	-	447	488	3,5	240	480	21	<b>NCF1884 V</b>
499	-	457,4	488,6	3	240	480	28,5	<b>NCF2884 V</b>
-	-	463	509	-	220	450	57,7	<b>NC2984 V</b>
524	-	463	509	5	220	450	57	<b>NCF2984 V</b>
-	-	474	506	3,5	220	450	22,6	<b>NC1888 V</b>
516	-	474	506	3,5	220	450	22	<b>NCF1888 V</b>
-	-	502	545	-	200	430	81,1	<b>NC2988 V</b>
565,5	-	502	545	6	200	430	80,5	<b>NCF2988 V</b>
-	-	501	541	5	200	430	34,8	<b>NC1892 V</b>
533	-	501	541	5	200	430	34	<b>NCF1892 V</b>
-	-	516	558	-	190	400	83,9	<b>NC2992 V</b>
579	-	516	558	6	190	400	83,5	<b>NCF2992 V</b>
573,5	-	522	561	5	190	400	35,5	<b>NCF1896 V</b>



### Single row full complement cylindrical roller bearings

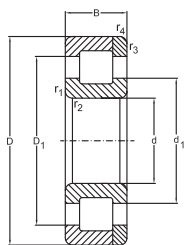

NC

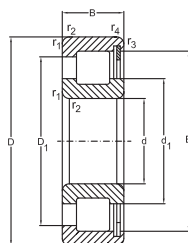

NCF

Dimensions					Basical radial load		Designation
d	D	B	r <sub>1</sub> , r <sub>2</sub> min.	r <sub>3</sub> , r <sub>4</sub> min.	dyn. C <sub>r</sub>	stat. C <sub>or</sub>	
mm					KN		
<b>480</b>	650	100	5	5	2290	4950	<b>NCF2996 V</b>
<b>500</b>	620	56	3	3	952	2120	<b>NCF18/500 V</b>
	670	100	5	5	2380	5240	<b>NCF29/500 V</b>
<b>530</b>	650	56	3	3	990	2110	<b>NCF18/530 V</b>
<b>560</b>	680	56	3	3	1020	2230	<b>NCF18/560 V</b>
<b>600</b>	730	60	3	3	1050	2350	<b>NCF18/600 V</b>
<b>630</b>	780	69	4	4	1250	2800	<b>NCF18/630 V</b>
<b>670</b>	820	69	4	4	1300	3000	<b>NCF18/670 V</b>
<b>710</b>	870	74	4	4	1540	3550	<b>NCF18/710 V</b>
<b>750</b>	920	78	5	5	1760	4030	<b>NCF18/750 V</b>

## Single row full complement cylindrical roller bearings

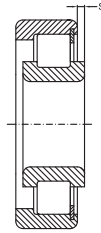

Abutment and fillet dimensions see on page 159

Dimensions					Speed Limit		Mass	Designation
E	F	$d_1$	$D_1$	s	grease	oil	Bearing	
mm					$\text{min}^{-1}$		kg	
606	-	538	584	-	180	380	98	<b>NCF2996 V</b>
594	-	542	582	5	180	380	36,5	<b>NCF18/500 V</b>
634,5	-	567	612	7	170	360	100	<b>NCF29/500 V</b>
624,5	-	573	612	5	170	360	38,5	<b>NCF18/530 V</b>
655	-	603	643	5	160	340	40	<b>NCF18/560 V</b>
696	-	644	684	7	150	320	49,9	<b>NCF18/600 V</b>
739	-	681	725	8	140	300	72,5	<b>NCF18/630 V</b>
783	-	725	769	8	130	280	76,5	<b>NCF18/670 V</b>
831	-	767	815	8	120	260	92,5	<b>NCF18/710 V</b>
880	-	811	863	8	110	240	110	<b>NCF18/750 V</b>

## Double Row Full Complement Cylindrical Roller Bearings

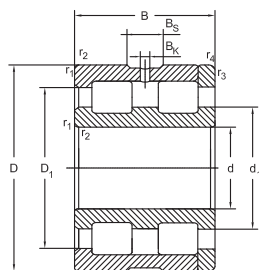

NNC

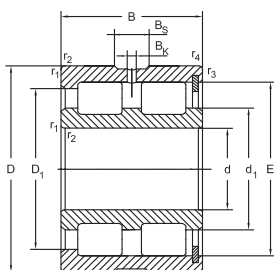

NNCF

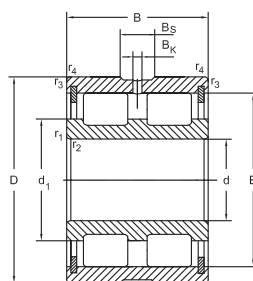

NNCL

Dimensions				Basical radial load		Speed Limit		Designation
d	D	B	$r_{1,2}$ min.	dyn. $C_r$	stat. $C_{or}$	grease	oil	
mm				KN		[min <sup>-1</sup> ]		
25	47	30	0,6	55	76,4	3800	7000	<b>NNCF5005 V</b>
30	55	34	1	73,7	105	3200	6000	<b>NNCF5006 V</b>
35	62	36	1	88	131	2800	5300	<b>NNCF5007 V</b>
40	68	38	1	105	159	2400	4800	<b>NNCF5008 V</b>
45	75	40	1	128	195	2000	4300	<b>NNCF5009 V</b>
50	80	40	1	132	206	1900	4000	<b>NNCF5010 V</b>
55	90	46	1,1	176	294	1600	3400	<b>NNCF5011 V</b>
60	85	25	1	76,5	134	1700	3400	<b>NNC4912 V</b>
	85	25	1	76,5	134	1700	3400	<b>NNCF4912 V</b>
	85	25	1	76,5	134	1700	3400	<b>NNCL4912 V</b>
	95	46	1,1	183	305	1600	3400	<b>NNCF5012 V</b>
65	100	46	1,1	194	331	1400	3000	<b>NNCF5013 V</b>
70	100	30	1	103	188	1400	3000	<b>NNC4914 V</b>
	100	30	1	103	188	1400	3000	<b>NNCF4914 V</b>
	100	30	1	103	188	1400	3000	<b>NNCL4914 V</b>
	110	54	1,1	220	361	1300	2800	<b>NNCF5014 V</b>
80	110	30	1	110	210	1200	2600	<b>NNC4916 V</b>
	110	30	1	110	210	1200	2600	<b>NNCF4916 V</b>
	110	30	1	110	210	1200	2600	<b>NNCL4916 V</b>
	125	60	1,1	286	469	1100	2400	<b>NNCF5016 V</b>



## Double Row Full Complement Cylindrical Roller Bearings

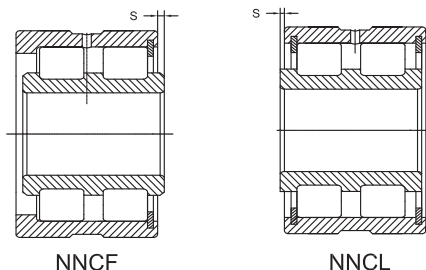

Abutment and fillet dimensions see on page 159

Dimensions							Mass
d	E	d <sub>1</sub>	D <sub>1</sub>	B <sub>s</sub>	B <sub>k</sub>	s	Bearing
mm							Kg
25	42,7	33,1	40,3	4,5	3	1	0,23
30	49,8	38,6	47	4,5	3	1	0,35
35	55,7	43,7	52,7	4,5	3	1	0,46
40	61,9	49,1	58,7	4,5	3	1	0,56
45	69,8	55,4	66,2	4,5	3	1	0,7
50	72,9	58,5	69,3	4,5	3	1	0,75
55	83,7	67,6	79,7	4,5	3,5	1	1,12
60	-	69,5	76,5	4,5	3,5	-	0,48
	78,9	69,5	76,5	4,5	3,5	1	0,46
	78,9	69,5	76,5	4,5	3,5	1	0,46
	86,9	70,9	82,9	4,5	3,5	1	1,25
65	93,3	77,3	89,3	4,5	3,5	1	1,3
70	-	82	89	4,5	3,5	-	0,8
	92,3	82	89	4,5	3,5	1	0,79
	92,3	82	89	4,5	3,5	1	0,79
	101	81,8	96,2	5	3,5	1,1	1,85
80	-	90,5	98	5	3,5	-	0,9
	101,2	90,5	98	5	3,5	1	0,88
	101,2	90,5	98	5	3,5	1	0,88
	117,2	94,8	112	5	3,5	2,5	2,5



## Double Row Full Complement Cylindrical Roller Bearings

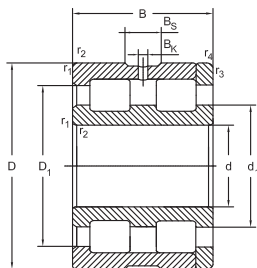

NNC

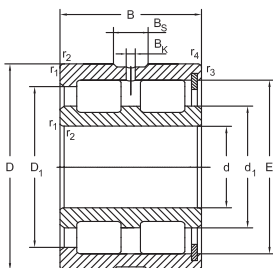

NNCF

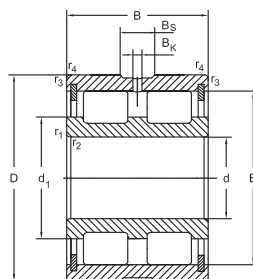

NNCL

Dimensions				Basical radial load		Speed Limit		Designation
d	D	B	$r_{1,2}$ min.	dyn. $C_r$	stat. $C_{or}$	grease	oil	
mm				KN		[min <sup>-1</sup> ]		
90	125	35	1,1	146	292	1100	2300	<b>NNC4918 V</b>
	125	35	1,1	146	292	1100	2300	<b>NNCF4918 V</b>
	125	35	1,1	146	292	1100	2300	<b>NNCL4918 V</b>
	140	67	1,5	369	635	1000	2200	<b>NNCF5018 V</b>
100	140	40	1,1	190	390	950	2000	<b>NNC4920 V</b>
	140	40	1,1	190	390	950	2000	<b>NNCF4920 V</b>
	140	40	1,1	190	390	950	2000	<b>NNCL4920 V</b>
	150	67	1,5	391	690	950	2000	<b>NNCF5020 V</b>
110	150	40	1,1	197	420	900	1900	<b>NNC4922 V</b>
	150	40	1,1	197	420	900	1900	<b>NNCF4922 V</b>
	150	40	1,1	197	420	900	1900	<b>NNCL4922 V</b>
	170	80	2	528	957	850	1800	<b>NNCF5022 V</b>
120	165	45	1,1	220	465	800	1700	<b>NNC4924 V</b>
	165	45	1,1	220	465	800	1700	<b>NNCF4924 V</b>
	165	45	1,1	220	465	800	1700	<b>NNCL4924 V</b>
	180	80	2	561	1050	800	1700	<b>NNCF5024 V</b>
130	180	50	1,5	255	540	750	1600	<b>NNC4926 V</b>
	180	50	1,5	255	540	750	1600	<b>NNCF4926 V</b>
	180	50	1,5	255	540	750	1600	<b>NNCL4926 V</b>
	200	95	2	704	1380	700	1500	<b>NNCF5026 V</b>

## Double Row Full Complement Cylindrical Roller Bearings

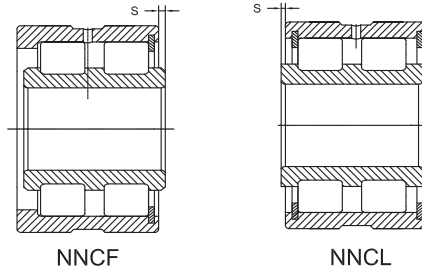

Abutment and fillet dimensions see on page 159

Dimensions							Mass
d	E	d <sub>1</sub>	D <sub>1</sub>	B <sub>s</sub>	B <sub>k</sub>	s	Bearing
mm							Kg
90	-	103,5	111,5	5	3,5	-	1,4
	115,5	103,5	111,5	5	3,5	1,5	1,37
	115,5	103,5	111,5	5	3,5	1,5	1,37
	130,3	106	125	5	3,5	2,5	3,75
100	-	116,5	125,5	5	3,5	-	1,8
	130	116,5	125,5	5	3,5	2	2
	130	116,5	125,5	5	3,5	2	2
	140	116	134	6	3,5	2,5	4,05
110	-	125	134	6	3,5	-	2,3
	138,6	125	134	6	3,5	2	2,2
	138,6	125	134	6	3,5	2	2,2
	157	128	150	6	3,5	2,5	6,6
120	-	139	149	6	3,5	-	2,9
	154	139	149	6	3,5	3	3
	154	139	149	6	3,5	3	3
	168	139	161	6	3,5	2,5	6,6
130	-	149,5	160,5	6	3,5	-	4,2
	166	149,5	160,5	6	3,5	4	4
	166	149,5	160,5	6	3,5	4	4
	183,5	153	176	6	3,5	2,5	11



## Double Row Full Complement Cylindrical Roller Bearings

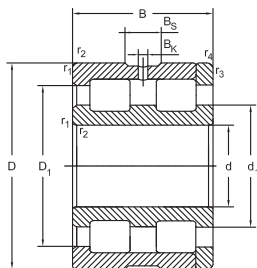

NNC

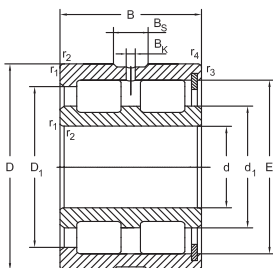

NNCF

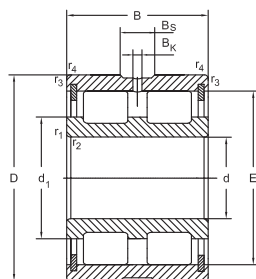

NNCL

Dimensions				Basical radial load		Speed Limit		Designation
d	D	B	$r_{1,2}$ min.	dyn. $C_r$	stat. $C_{or}$	grease	oil	
mm				KN		[min <sup>-1</sup> ]		
140	190	50	1,5	265	576	700	1500	NNC4928 V
	190	50	1,5	265	576	700	1500	NNCF4928 V
	190	50	1,5	265	576	700	1500	NNCL4928 V
	210	95	2	737	1500	670	1400	NNCF5028 V
150	190	40	1,1	230	560	720	1500	NNC4830 V
	190	40	1,1	230	560	720	1500	NNCF4830 V
	190	40	1,1	230	560	720	1500	NNCL4830 V
	210	60	2	383	843	680	1400	NNC4930 V
	210	60	2	383	843	680	1400	NNCF4930 V
	210	60	2	383	843	680	1400	NNCL4930 V
	225	100	2,1	842	1680	630	1300	NNCF5030 V
160	200	40	1,1	238	600	680	1400	NNC4832 V
	200	40	1,1	238	600	680	1400	NNCF4832 V
	200	40	1,1	238	600	680	1400	NNCL4832 V
	220	60	2	399	906	650	1300	NNC4932 V
	220	60	2	399	906	650	1300	NNCF4932 V
	220	60	2	399	906	650	1300	NNCL4932 V
	240	109	2,1	1010	1950	600	1200	NNCF5032 V
170	215	45	1,1	258	631	640	1300	NNC4834 V
	215	45	1,1	258	631	640	1300	NNCF4834 V

## Double Row Full Complement Cylindrical Roller Bearings

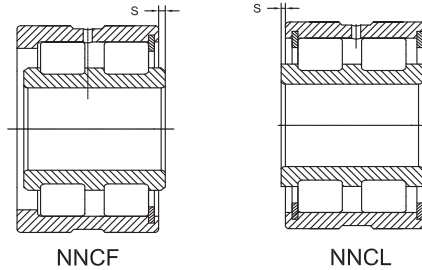

Abutment and fillet dimensions see on page 159

Dimensions							Mass
d	E	d <sub>1</sub>	D <sub>1</sub>	B <sub>s</sub>	B <sub>k</sub>	s	Bearing
mm							Kg
140	-	160	171	6	3,5	-	4,1
	176,4	160	171	6	3,5	4	4,2
	176,4	160	171	6	3,5	4	4,2
	195,5	165	188	7	4	3	11,5
150	-	165	174	7	4	-	3
	178,7	165	174	7	4	2	2,8
	178,7	165	-	7	4	2	2,8
	-	172,5	185,5	7	4	-	6,5
	192	172,5	185,5	7	4	4	6,8
	192	172,5	185,5	7	4	4	6,8
	209	175	201	7	4	3	14
160	-	176,5	185,5	7	4	-	3
	190,1	176,5	185,5	7	4	2	3
	190,1	176,5	-	7	4	2	3
	-	184,5	197,5	7	4	-	7,2
	203,9	184,5	197,5	7	4	4	7,1
	203,9	184,5	197,5	7	4	4	7,1
	225	185	215	7	4	3	17
170	-	187,5	196,5	7	4	-	4
	201,7	187,5	196,5	7	4	3	4



## Double Row Full Complement Cylindrical Roller Bearings

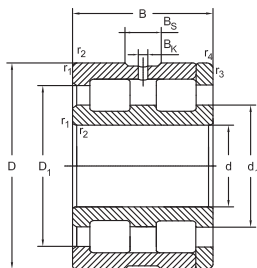

NNC

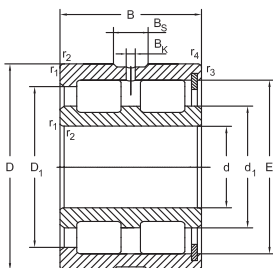

NNCF

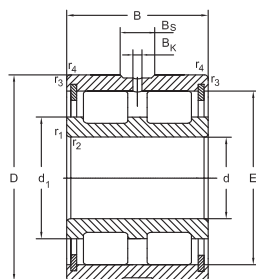

NNCL

Dimensions				Basical radial load		Speed Limit		Designation
d	D	B	$r_1, r_2$ min.	dyn. $C_r$	stat. $C_{or}$	grease	oil	
mm				KN		[min <sup>-1</sup> ]		
170	215	45	1,1	258	631	640	1300	NNCL4834 V
	230	60	2	408	950	600	1200	NNC4934 V
	230	60	2	408	950	600	1200	NNCF4934 V
	230	60	2	408	950	600	1200	NNCL4934 V
	260	122	2,1	1140	2170	560	1100	NNCF5034 V
180	225	45	1,1	266	664	610	1200	NNC4836 V
	225	45	1,1	266	664	610	1200	NNCF4836 V
	225	45	1,1	266	664	610	1200	NNCL4836 V
	250	69	2	547	1220	570	1100	NNC4936 V
	250	69	2	547	1220	570	1100	NNCF4936 V
	250	69	2	547	1220	570	1100	NNCL4936 V
	280	136	2,1	1320	2580	560	1100	NNCF5036 V
190	240	50	1,5	305	760	560	1150	NNC4838 V
	240	50	1,5	305	760	560	1150	NNCF4838 V
	240	50	1,5	305	760	560	1150	NNCL4838 V
	260	69	2	562	1290	550	1100	NNC4938 V
	260	69	2	562	1290	550	1100	NNCF4938 V
	260	69	2	562	1290	550	1100	NNCL4938 V
	290	136	2,1	1380	2690	530	1000	NNCF5038 V
200	250	50	1,5	315	799	550	1100	NNC4840 V

## Double Row Full Complement Cylindrical Roller Bearings

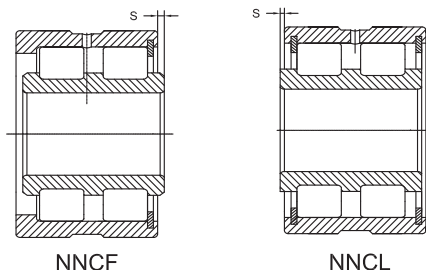

Abutment and fillet dimensions see on page 159

Dimensions							Mass
d	E	d <sub>1</sub>	D <sub>1</sub>	B <sub>s</sub>	B <sub>k</sub>	s	Bearing
mm							Kg
<b>170</b>	201,7	187,5	-	7	4	3	4
	-	192,5	205,5	7	4	-	7,4
	212,2	192,5	205,5	7	4	4	7,5
	212,2	192,5	205,5	7	4	4	7,5
	243	198	232	7	4	5	23
<b>180</b>	-	196	207	7	4	-	4,1
	211,3	196	207	7	4	3	4,2
	211,3	196	-	7	4	3	4,2
	-	207	223	7	4	-	11
	231,1	207	223	7	4	4	10,8
	231,1	207	223	7	4	4	10,8
	260,5	212	249	8	4	6	30,5
<b>190</b>	-	209	220	7	4	-	5,6
	225,4	209	220	7	4	4	5,5
	225,4	209	-	7	4	4	5,5
	-	217,5	233	7	4	-	11,5
	241,3	217,5	233	7	4	4	11,3
	241,3	217,5	233	7	4	4	11,3
	270	222	258	8	4	6	31,5
<b>200</b>	-	219,5	230	7	4	-	5,7



## Double Row Full Complement Cylindrical Roller Bearings

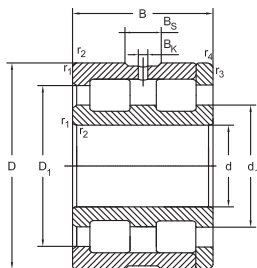

NNC

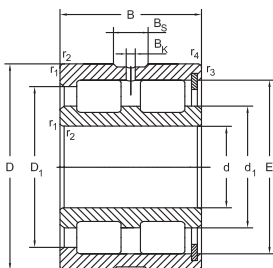

NNCF

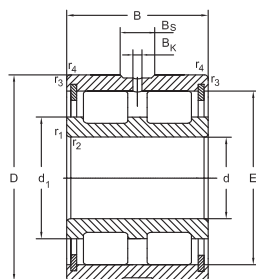

NNCL

Dimensions				Basical radial load		Speed Limit		Designation
d	D	B	$r_{1,2}$ min.	dyn. $C_r$	stat. $C_{or}$	grease	oil	
mm				KN		[min <sup>-1</sup> ]		
200	250	50	1,5	315	799	550	1100	NNCF4840 V
	250	50	1,5	315	799	550	1100	NNCL4840 V
	280	80	2,1	661	1495	530	1000	NNC4940 V
	280	80	2,1	661	1495	530	1000	NNCF4940 V
	280	80	2,1	661	1495	530	1000	NNCL4940 V
	310	150	2,1	1570	3130	500	950	NNCF5040 V
220	270	50	1,5	330	878	500	1000	NNC4844 V
	270	50	1,5	330	878	500	1000	NNCF4844 V
	270	50	1,5	330	878	500	1000	NNCL4844 V
	300	80	2,1	690	1610	500	950	NNC4944 V
	300	80	2,1	690	1610	500	950	NNCF4944 V
	300	80	2,1	690	1610	500	950	NNCL4944 V
	340	160	3	1870	3680	450	850	NNCF5044 V
240	300	60	2	497	1292	480	900	NNC4848 V
	300	60	2	497	1292	480	900	NNCF4848 V
	300	60	2	497	1292	480	900	NNCL4848 V
	320	80	2,1	725	1762	450	850	NNC4948 V
	320	80	2,1	725	1762	450	850	NNCF4948 V
	320	80	2,1	725	1762	450	850	NNCL4948 V
	360	160	3	1980	4050	450	800	NNCF5048 V



## Double Row Full Complement Cylindrical Roller Bearings

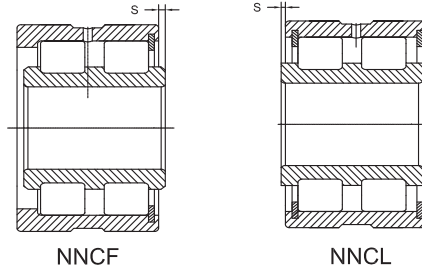

Abutment and fillet dimensions see on page 159

Dimensions							Mass
d	E	d <sub>1</sub>	D <sub>1</sub>	B <sub>s</sub>	B <sub>k</sub>	s	Bearing
mm							Kg
200	235,9	219,5	230	7	4	4	5,8
	235,9	219,5	-	7	4	4	5,8
	-	233	251	8	4	-	14,9
	260	233	251	8	4	5	15,9
	260	233	251	8	4	5	15,9
	288	236	276	8	4	7	41
220	-	240,5	251,5	7	4	-	6,2
	256,9	240,5	251,5	7	4	4	6,3
	256,9	240,5	-	7	4	4	6,3
	-	250	268	8	4	-	17
	277,2	250	268	8	4	5	17,2
	277,2	250	268	8	4	5	17,2
	315,5	255	300	8	4	7	52,5
240	-	261,5	275,5	8	4	-	9,9
	282,4	261,5	275,5	8	4	4	10
	282,4	261,5	-	8	4	4	10
	-	273	291	8	4	-	18,7
	300,1	273	291	8	4	5	18,5
	300,1	273	291	8	4	5	18,5
	335,6	278	322	9,4	5	7	56



## Double Row Full Complement Cylindrical Roller Bearings

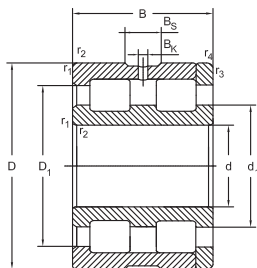

NNC

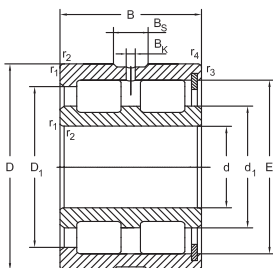

NNCF

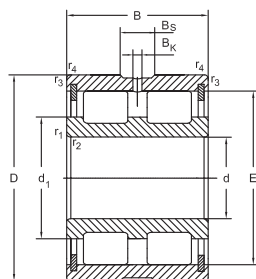

NNCL

Dimensions				Basical radial load		Speed Limit		Designation
d	D	B	$r_1, r_2$ min.	dyn. $C_r$	stat. $C_{or}$	grease	oil	
mm				KN		[min <sup>-1</sup> ]		
260	320	60	2	521	1406	430	820	NNC4852 V
	320	60	2	521	1406	430	820	NNCF4852 V
	320	60	2	521	1406	430	820	NNCL4852 V
	360	100	2,1	1070	2520	400	750	NNC4952 V
	360	100	2,1	1070	2520	400	750	NNCF4952 V
	360	100	2,1	1070	2520	400	750	NNCL4952 V
280	400	190	4	2640	5340	380	700	NNCF5052 V
	350	69	2	680	1853	400	750	NNC4856 V
	350	69	2	680	1853	400	750	NNCF4856 V
	350	69	2	680	1853	400	750	NNCL4856 V
	380	100	2,1	1120	2710	380	700	NNC4956 V
	380	100	2,1	1120	2710	380	700	NNCF4956 V
	380	100	2,1	1120	2710	380	700	NNCL4956 V
300	420	190	4	2700	5610	360	670	NNCF5056 V
	380	80	2,1	801	2146	380	700	NNC4860 V
	380	80	2,1	801	2146	380	700	NNCF4860 V
	380	80	2,1	801	2146	380	700	NNCL4860 V
	420	118	3	1560	3630	340	650	NNC4960 V
	420	118	3	1560	3630	340	650	NNCF4960 V
	420	118	3	1560	3630	340	650	NNCL4960 V

## Double Row Full Complement Cylindrical Roller Bearings

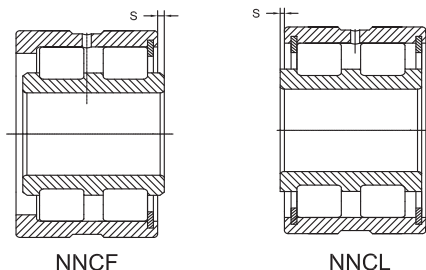

Abutment and fillet dimensions see on page 159

Dimensions							Mass
d	E	d <sub>1</sub>	D <sub>1</sub>	B <sub>s</sub>	B <sub>k</sub>	s	Bearing
mm							Kg
260	-	283,5	297,5	8	4	-	10,7
	304,7	283,5	297,5	8	4	4	10,8
	304,7	283,5	-	8	4	4	10,8
	-	297	320	9,4	5	-	33,1
	331,5	297	320	9,4	5	6	32,2
	331,5	297	320	9,4	5	6	32,2
	373,5	304	357	9,4	5	7	85,5
280	-	309	325	8	4	-	16,1
	332,9	309	325	8	4	4	15,8
	332,9	309	-	8	4	4	15,8
	-	319	342	9,4	5	-	34,5
	353,5	319	342	9,4	5	6	34,2
	353,5	319	342	9,4	5	6	34,2
	389	320	372	9,4	5	7	90,5
300	-	330,5	348,5	9,4	5	-	22,9
	357,4	330,5	348,5	9,4	5	6	22,5
	357,4	330,5	-	9,4	5	6	22,5
	-	346,5	375,5	9,4	5	-	53
	390,2	346,5	375,5	9,4	5	6	52,8
	390,2	346,5	375,5	9,4	5	6	52,8



## Double Row Full Complement Cylindrical Roller Bearings

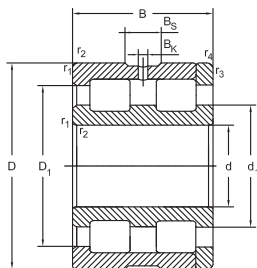

NNC

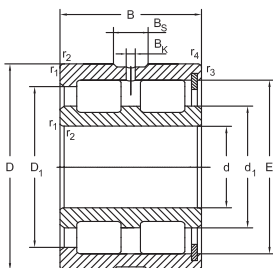

NNCF

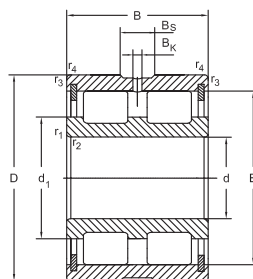

NNCL

Dimensions				Basical radial load		Speed Limit		Designation
d	D	B	$r_{1,2}$ min.	dyn. $C_r$	stat. $C_{or}$	grease	oil	
mm				KN		[min <sup>-1</sup> ]		
<b>300</b>	460	218	4	3410	7180	320	600	<b>NNCF5060 V</b>
<b>320</b>	400	80	2,1	832	2300	340	640	<b>NNC4864 V</b>
	400	80	2,1	832	2300	340	640	<b>NNCF4864 V</b>
	400	80	2,1	832	2300	340	640	<b>NNCL4864 V</b>
	440	118	3	1600	3835	320	600	<b>NNC4964 V</b>
	440	118	3	1600	3835	320	600	<b>NNCF4964 V</b>
	440	118	3	1600	3835	320	600	<b>NNCL4964 V</b>
	480	218	4	3470	7450	300	560	<b>NNCF5064 V</b>
<b>340</b>	420	80	2,1	850	2415	320	600	<b>NNC4868 V</b>
	420	80	2,1	850	2415	320	600	<b>NNCF4868 V</b>
	420	80	2,1	850	2415	320	600	<b>NNCL4868 V</b>
	460	118	3	1640	4035	300	560	<b>NNC4968 V</b>
	460	118	3	1640	4035	300	560	<b>NNCF4968 V</b>
	460	118	3	1640	4035	300	560	<b>NNCL4968 V</b>
	520	243	5	4180	9200	280	530	<b>NNCF5068 V</b>
<b>360</b>	440	80	2,1	880	2570	300	560	<b>NNC4872 V</b>
	440	80	2,1	880	2570	300	560	<b>NNCF4872 V</b>
	440	80	2,1	880	2570	300	560	<b>NNCL4872 V</b>
	480	118	2,5	1690	4240	300	550	<b>NNC4972 V</b>
	480	118	2,5	1690	4240	300	550	<b>NNCF4972 V</b>

## Double Row Full Complement Cylindrical Roller Bearings

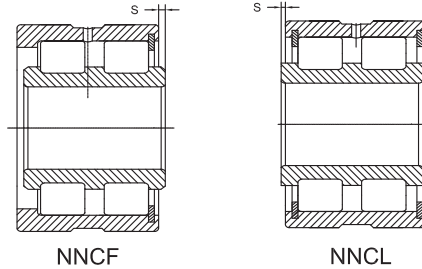

Abutment and fillet dimensions see on page 159

Dimensions							Mass
d	E	d <sub>i</sub>	D <sub>i</sub>	B <sub>s</sub>	B <sub>k</sub>	s	Bearing
mm							Kg
<b>300</b>	432	355	413	9,4	5	9	130
<b>320</b>	-	353,5	371,5	9,4	5	-	24
	380,3	353,5	371,5	9,4	5	6	23,8
	380,3	353,5	-	9,4	5	6	23,8
	-	353,5	399	9,4	5	-	56
	409	353,5	399	9,4	5	6	55,2
	409	353,5	399	9,4	5	6	55,2
	447,5	370	429	9,4	5	9	135
<b>340</b>	-	370,5	388,5	9,4	5	-	25,5
	397,4	370,5	388,5	9,4	5	6	25,2
	397,4	370,5	-	9,4	5	6	25,2
	-	383,5	412,5	9,4	5	-	60,5
	427,1	383,5	412,5	9,4	5	6	58,8
	427,1	383,5	412,5	9,4	5	6	58,8
	486	399	465	9,4	5	11	185
<b>360</b>	-	393	411	9,4	5	-	27
	420,2	393	411	9,4	5	6	26,5
	420,2	393	-	9,4	5	6	26,5
	-	399	436,5	9,4	5	-	61
	446	399	436,5	9,4	5	6	60,5



## Double Row Full Complement Cylindrical Roller Bearings

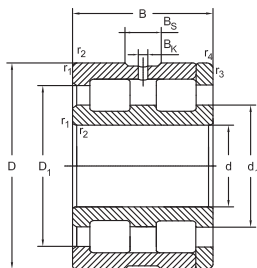

NNC

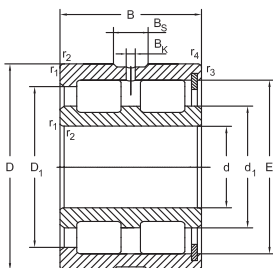

NNCF

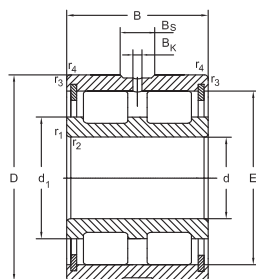

NNCL

Dimensions				Basical radial load		Speed Limit		Designation
d	D	B	$r_1, r_2$ min.	dyn. $C_r$	stat. $C_{or}$	grease	oil	
mm				KN		[min <sup>-1</sup> ]		
360	540	243	5	4290	9570	260	500	<b>NNCF5072 V</b>
	480	100	2,1	1293	3618	280	530	<b>NNC4876 V</b>
380	480	100	2,1	1293	3618	280	530	<b>NNCF4876 V</b>
	480	100	2,1	1293	3618	280	530	<b>NNCL4876 V</b>
	520	140	4	2124	5460	260	500	<b>NNC4976 V</b>
	520	140	4	2124	5460	260	500	<b>NNCF4976 V</b>
	520	140	4	2124	5460	260	500	<b>NNCL4976 V</b>
	560	243	5	4400	9940	240	480	<b>NNCF5076 V</b>
400	500	100	2,1	1311	3748	270	500	<b>NNC4880 V</b>
	500	100	2,1	1311	3748	270	500	<b>NNCF4880 V</b>
	500	100	2,1	1311	3748	270	500	<b>NNCL4880 V</b>
	540	140	4	2185	5730	240	480	<b>NNC4980 V</b>
	540	140	4	2185	5730	240	480	<b>NNCF4980 V</b>
	540	140	4	2185	5730	240	480	<b>NNCL4980 V</b>
	600	272	5	5500	12300	220	450	<b>NNCF5080 V</b>
420	520	100	2,1	1353	3942	250	470	<b>NNC4884 V</b>
	520	100	2,1	1353	3942	250	470	<b>NNCF4884 V</b>
	520	100	2,1	1353	3942	250	470	<b>NNCL4884 V</b>
	560	140	4	2235	6000	220	450	<b>NNC4984 V</b>
	560	140	4	2235	6000	220	450	<b>NNCF4984 V</b>

## Double Row Full Complement Cylindrical Roller Bearings

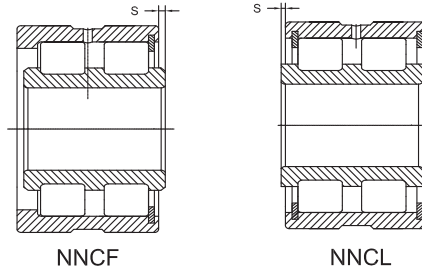

Abutment and fillet dimensions see on page 159

Dimensions							Mass
d	E	d <sub>i</sub>	D <sub>i</sub>	B <sub>s</sub>	B <sub>k</sub>	s	Bearing
mm							Kg
<b>360</b>	504	417	483	9,4	5	11	195
<b>380</b>	-	421,5	444,5	9,4	5	-	45
	456	421,5	444,5	9,4	5	6	44,6
	456	421,5	-	9,4	5	6	44,6
	-	433,5	465,5	9,4	5	-	93
	481,5	433,5	465,5	9,4	5	7	92,4
	481,5	433,5	465,5	9,4	5	7	92,4
	532	435	511	9,4	5	11	200
<b>400</b>	-	436	459	9,4	5	-	47
	470,3	436	459	9,4	5	6	46,8
	470,3	436	-	9,4	5	6	46,8
	-	454	486	9,4	5	-	97,5
	502	454	486	9,4	5	7	96,5
	502	454	486	9,4	5	7	96,5
	560	464	536	9,4	5	11	270
<b>420</b>	-	458	481	9,4	5	-	49,2
	492,5	458	481	9,4	5	6	48,8
	492,5	458	-	9,4	5	6	48,8
	-	470,5	512	9,4	5	-	100
	522,5	470,5	512	9,4	5	7	99



## Double Row Full Complement Cylindrical Roller Bearings

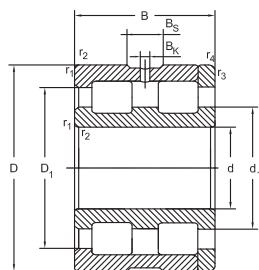

NNC

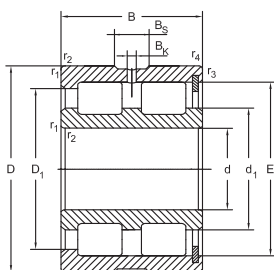

NNCF

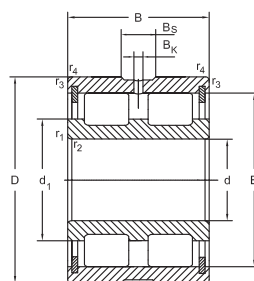

NNCL

Dimensions				Basical radial load		Speed Limit		Designation
d	D	B	$r_1, r_2$ min.	dyn. $C_r$	stat. $C_{or}$	grease	oil	
mm				KN		[min <sup>-1</sup> ]		
420	560	140	4	2235	6000	220	450	NNCL4984 V
	620	272	5	5610	12800	200	430	NNCF5084 V
440	540	100	2,1	1387	4136	240	450	NNC4888 V
	540	100	2,1	1387	4136	240	450	NNCF4888 V
	540	100	2,1	1387	4136	240	450	NNCL4888 V
	600	160	4	2990	7570	200	430	NNC4988 V
	600	160	4	2990	7570	200	430	NNCF4988 V
	600	160	4	2990	7570	200	430	NNCL4988 V
	650	280	6	6160	14100	190	400	NNCF5088 V
460	580	118	3	1560	4614	230	420	NNC4892 V
	580	118	3	1560	4614	230	420	NNCF4892 V
	580	118	3	1560	4614	230	420	NNCL4892 V
	620	160	4	3020	7770	190	400	NNC4992 V
	620	160	4	3020	7770	190	400	NNCF4992 V
	620	160	4	3020	7770	190	400	NNCL4992 V
	680	130	6	6440	14700	180	380	NNCF5092 V
480	600	118	3	1597	4838	210	400	NNC4896 V
	600	118	3	1597	4838	210	400	NNCF4896 V
	600	118	3	1597	4838	210	400	NNCL4896 V
	650	170	5	3270	8420	180	360	NNC4996 V



## Double Row Full Complement Cylindrical Roller Bearings

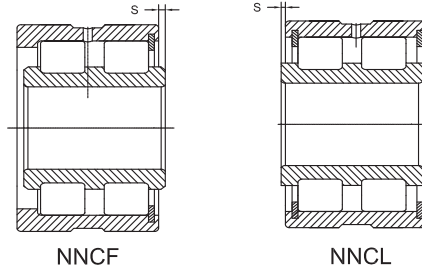

Abutment and fillet dimensions see on page 159

Dimensions							Mass
d	E	d <sub>1</sub>	D <sub>1</sub>	B <sub>s</sub>	B <sub>k</sub>	s	Bearing
mm							Kg
420	522,5	470,5	512	9,4	5	7	99
	579	483	555	9,4	5	11	280
440	-	480	503	9,4	5	-	51,5
	541,6	480	503	9,4	5	6	50,9
	514,6	480	-	9,4	5	6	50,9
	-	503,5	543,5	9,4	5	-	140
	563,5	503,5	543,5	9,4	5	7	138
	563,5	503,5	543,5	9,4	5	7	138
	608	507	583	9,4	5	11	320
460	-	506	531	9,4	5	-	77,5
	543,3	506	531	9,4	5	7	76,9
	543,3	506	-	9,4	5	7	76,9
	-	512	564	9,4	5	-	145
	577	512	564	9,4	5	7	141
	577	512	564	9,4	5	7	141
	638	527	609	9,4	5	14	365
480	-	530	555	9,4	5	-	80
	567,3	530	555	9,4	5	7	89,8
	567,3	530	-	9,4	5	7	89,8
	-	537	592	9,4	5	-	170



## Double Row Full Complement Cylindrical Roller Bearings

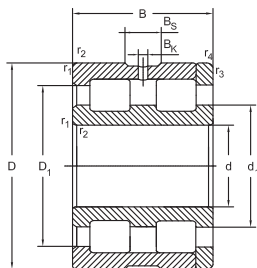

NNC

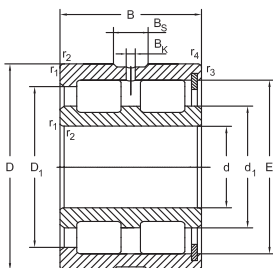

NNCF

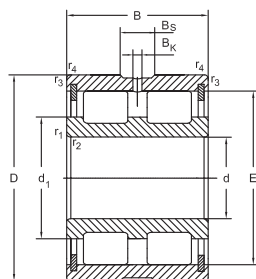

NNCL

Dimensions				Basical radial load		Speed Limit		Designation
d	D	B	$r_1, r_2$ min.	dyn. $C_r$	stat. $C_{or}$	grease	oil	
mm				KN		[min <sup>-1</sup> ]		
480	650	170	5	3270	8420	180	360	NNCF4996 V
	650	170	5	3270	8420	180	360	NNCL4996 V
	700	300	6	6710	15300	170	360	NNCF5096 V
500	620	118	3	1625	4987	200	380	NNC48/500 V
	620	118	3	1625	4987	200	380	NNCF48/500 V
	620	118	3	1625	4987	200	380	NNCL48/500 V
	670	170	5	3350	8850	170	360	NNC49/500 V
	670	170	5	3350	8850	170	360	NNCF49/500 V
	670	170	5	3350	8850	170	360	NNCL49/500 V
	720	300	6	6820	15900	170	360	NNCF50/500 V
530	650	118	3	5285	5285	180	340	NNC48/530 V
	650	118	3	2285	5285	180	340	NNCF48/530 V
	650	118	3	5285	5285	180	340	NNCL48/530 V
	710	180	4	10100	10100	160	340	NNC49/530 V
	710	180	4	10100	10100	160	340	NNCF49/530 V
	710	180	4	10100	10100	160	340	NNCL49/530 V

## Double Row Full Complement Cylindrical Roller Bearings

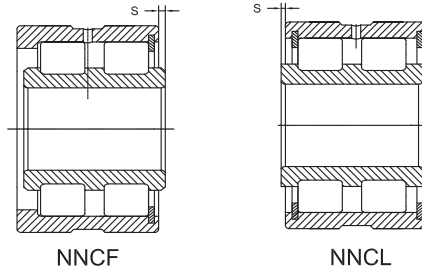

Abutment and fillet dimensions see on page 159

Dimensions							Mass
d	E	d <sub>1</sub>	D <sub>1</sub>	B <sub>s</sub>	B <sub>k</sub>	s	Bearing
mm							Kg
480	605,5	537	592	9,4	5	8	166
	605,5	537	592	9,4	5	8	166
	657	548	630	9,4	5	14	380
500	-	547	571	9,4	5	-	82,5
	583,5	547	571	9,4	5	7	83
	583,5	547	-	9,4	5	7	83
	-	568,5	610,5	9,4	5	-	179
	631,5	568,5	610,5	9,4	5	8	175
	631,5	568,5	610,5	9,4	5	8	175
	678	569	651	9,4	5	14	390
530	-	577,5	602,5	9,4	5	-	87,5
	615	577,5	602,5	9,4	5	6	87,2
	615	577,5	-	9,4	5	6	87,2
	-	588	648	9,4	5	-	208
	663	588	648	9,4	5	8	205
	663	588	648	9,4	5	8	205



## Sealed Double Row Full Complement Cylindrical Roller Bearings

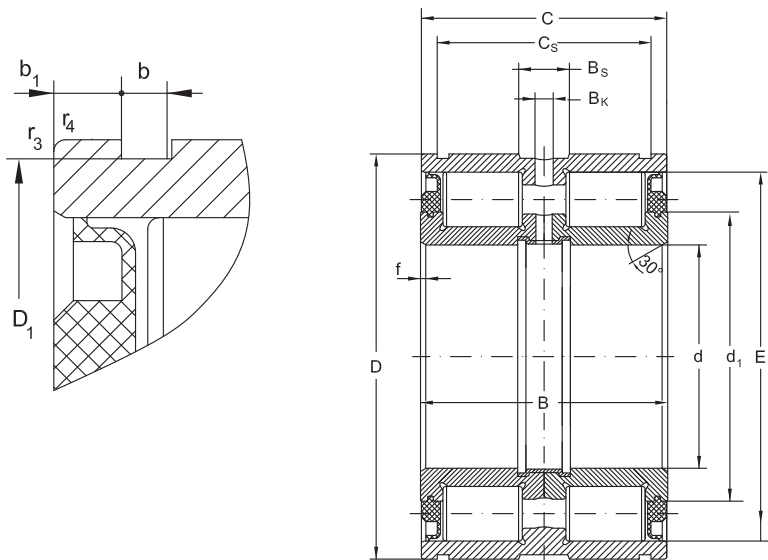

Dimensions						Basical radial load		Speed Limit	Designation
d	D	B	C	C <sub>s</sub>	r <sub>1</sub> , r <sub>2</sub> min.	dyn. C <sub>r</sub>	stat. C <sub>or</sub>	grease	
mm						KN		[min <sup>-1</sup> ]	
25	47	30	29	24,7	0,3	44,5	65,3	3000	NNF5005 2RSRV
30	55	34	33	28,2	0,3	48,5	70	2600	NNF5006 2RSRV
35	62	36	35	30,2	0,3	66	95,8	2200	NNF5007 2RSRV
40	68	38	37	32,2	0,6	79	121	2000	NNF5008 2RSRV
45	75	40	39	34,2	0,6	95,1	150	1800	NNF5009 2RSRV
50	80	40	39	34,2	0,6	101	162	1700	NNF5010 2RSRV
55	90	46	45	40,2	0,6	119	195	1500	NNF5011 2RSRV
60	95	46	45	40,2	0,6	123	210	1400	NNF5012 2RSRV
65	100	46	45	40,2	0,6	128	224	1300	NNF5013 2RSRV
70	110	54	53	48,2	0,6	190	337	1200	NNF5014 2RSRV
80	125	60	59	54,2	0,6	233	420	1000	NNF5016 2RSRV
90	140	67	66	59,2	0,6	297	552	900	NNF5018 2RSRV
100	150	67	66	59,2	0,6	314	580	850	NNF5020 2RSRV
110	170	80	79	70,2	0,6	380	699	750	NNF5022 2RSRV
120	180	80	79	71,2	0,6	402	745	700	NNF5024 2RSRV

## Sealed Double Row Full Complement Cylindrical Roller Bearings

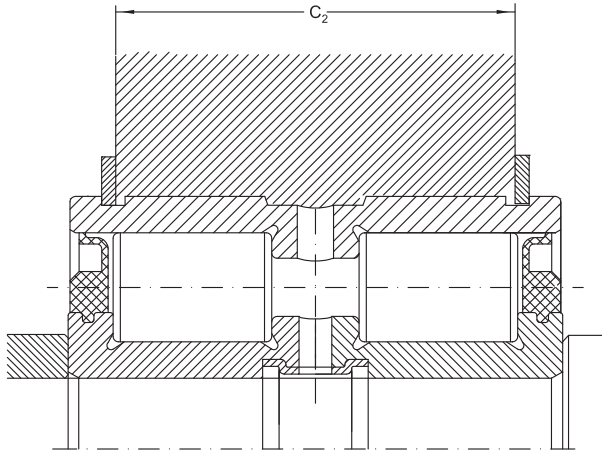

Abutment and fillet dimensions see on page 159

Dimensions										Adequate snap ring acc <b>ISO 464</b>	Mass Bearing
d	d <sub>1</sub>	D <sub>1</sub>	E	b	b <sub>1</sub>	B <sub>s</sub>	Bk	f	C <sub>2</sub> ±0,1		
mm											
25	33	44,8	40,4	1,8	2,15	4,5	3	0,5	21	47x1,75	0,23
30	39	52,8	47,9	2,1	2,4	4,5	3	0,5	24	55x2	0,35
35	45	59,8	54,5	2,1	2,4	4,5	3	0,5	26	62x2	0,45
40	50,5	65,8	61	2,7	2,4	4,5	3	0,8	27	68x2,5	0,53
45	56,4	72,8	67,7	2,7	2,4	4,5	3	0,8	29	75x2,5	0,68
50	61,2	77,8	72,5	2,7	2,4	4,5	3	0,8	29	80x2,5	0,73
55	68	87,4	80	3,2	2,4	4,5	3,5	1	34	90x3	1,1
60	73	92,5	85	3,2	2,4	4,5	3,5	1	34	95x3	1,2
65	78	97,4	90	3,2	2,4	4,5	3,5	1	34	100x3	1,3
70	85	107,1	100	4,2	2,4	5	3,5	1	40	110x4	1,85
80	97	122,1	113,5	4,2	2,4	5	3,5	1,5	46	125x4	2,7
90	109	137	127,5	4,2	3,4	5	3,5	1,5	51	140x4	3,8
100	118	147	138	4,2	3,4	6	3,5	1,5	51	150x4	4,05
110	132	167	154,5	4,2	4,4	6	3,5	1,8	62	170x4	6,45
120	141	176	164	4,2	3,9	6	3,5	1,8	63	180x4	6,9



## Sealed Double Row Full Complement Cylindrical Roller Bearings

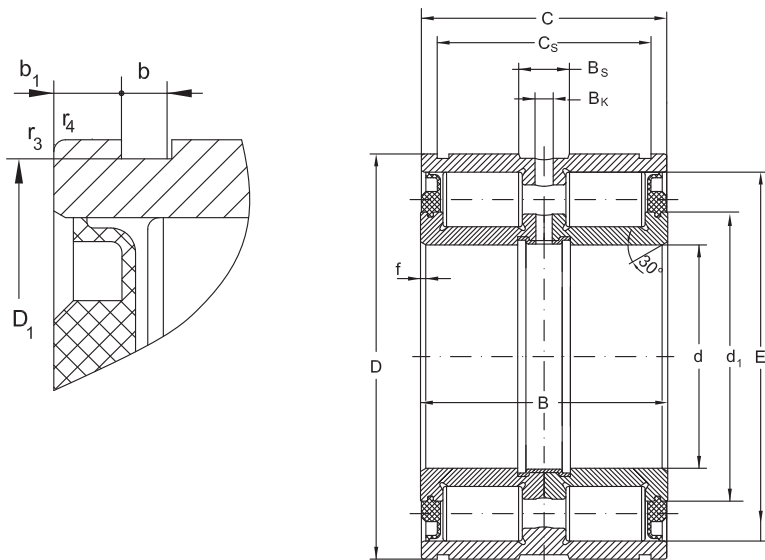

Dimensions						Basical radial load		Speed Limit	Designation
d	D	B	C	C <sub>s</sub>	r <sub>1</sub> , r <sub>2</sub> min.	dyn. C <sub>r</sub>	stat. C <sub>or</sub>	grease	
mm						KN		[min <sup>-1</sup> ]	
130	200	95	94	83,2	0,6	572	1050	630	NNF5026 2RSRV
140	210	95	94	83,2	0,6	594	1140	600	NNF5028 2RSRV
150	225	100	99	87,2	0,6	693	1310	560	NNF5030 2RSRV
160	240	109	108	95,2	0,6	721	1410	500	NNF5032 2RSRV
170	260	122	121	107,2	0,6	935	1800	480	NNF5034 2RSRV
180	280	136	135	118,2	0,6	1080	2130	450	NNF5036 2RSRV
190	290	136	135	118,2	0,6	1100	2210	430	NNF5038 2RSRV
200	310	150	149	128,2	0,6	1340	2870	400	NNF5040 2RSRV
220	340	160	159	138,2	1	1510	3130	360	NNF5044 2RSRV
240	360	160	159	138,2	1	1570	3310	340	NNF5048 2RSRV

## Sealed Double Row Full Complement Cylindrical Roller Bearings

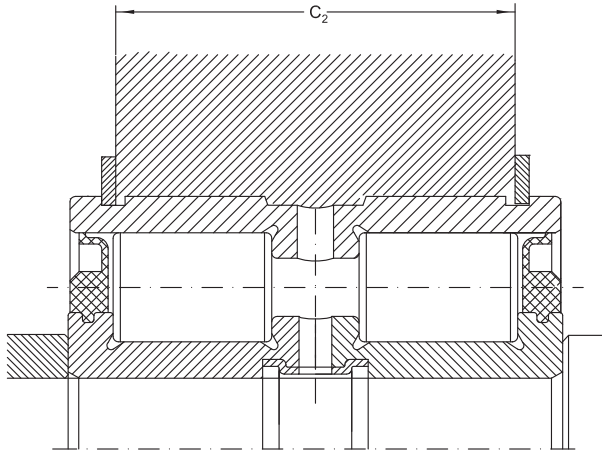

Abutment and fillet dimensions see on page 159

Dimensions										Adequate snap ring acc ISO 464	Mass
d	d <sub>1</sub>	D <sub>1</sub>	E	b	b <sub>1</sub>	B <sub>s</sub>	Bk	f	C <sub>2</sub> ±0,1		Bearing
mm											
<b>130</b>	155	196	183,5	4,2	5,4	7	4	1,8	75	200x4	10,5
<b>140</b>	167	206	195,5	5,2	5,4	7	4	1,8	73	210x5	11
<b>150</b>	177	221	209,2	5,2	5,9	7	4	2	77	225x5	13,5
<b>160</b>	191	236	222,6	5,2	6,4	7	4	2	85	240x5	16,5
<b>170</b>	203	254	239	5,2	6,9	7	4	2	97	260x5	22,5
<b>180</b>	220	274	259	5,2	8,4	8	4	2	108	280x5	30
<b>190</b>	228	284	267,3	5,2	8,4	8	4	2	108	290x5	31,5
<b>200</b>	245	304	284	6,3	10,4	8	4	2	116	310x6	42
<b>220</b>	264	334	308,5	6,3	10,4	8	6	2	126	340x6	53,5
<b>240</b>	283	354	327,5	6,3	10,4	9,4	6	2	126	360x6	57,5



### Cylindrical Roller Bearings for axle-boxes

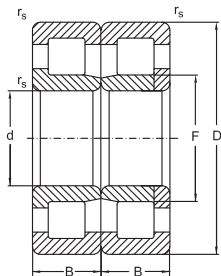

NJ+NJP  
WJ+WJP

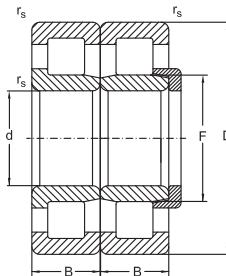

WJ+WUJ

Dimensions					Basical radial load		Speed limit	Mass	Designation
d	D	B	r <sub>s</sub> min.	F	dyn. C <sub>r</sub>	stat. C <sub>or</sub>	grease		
mm					KN		min <sup>-1</sup>	kg	
<b>85</b>	170	60	3	105	578	862	2800	14,1	<b>NJ+NJP85/170 MAP63</b>
<b>110</b>	215	73	3	135,5	773	1188	2600	25,4	<b>WJ+WJP110/215 M</b>
	215	73	3	135,5	773	1188	2600	26,1	<b>WJ+WUJ110/215 M</b>
	215	76	3	134,5	911	1438	2600	24,36	<b>WJ+WJP110x215x76 TN</b>
<b>120</b>	240	80	3	150	946	1484	2400	34	<b>WJ+WJP120/240 M</b>
	240	80	3	150	946	1484	2400	31,8	<b>WJ+WJP120/240 TN</b>
	240	80	3	150	946	1484	2400	32,3	<b>WJ+WJP118/240 TN</b>
	240	80	3	150	946	1484	2400	32	<b>WJ+WJP119/240 TN</b>
<b>130</b>	240	80	3	157	951	1620	2200	32,8	<b>WJ+WJP130/240 M</b>
	240	80	3	157	951	1620	2200	30,2	<b>WJ+WJP130/240 TN</b>
	240	80	3	157	951	1620	2200	31	<b>WJ+WJP128/240 TN</b>
	240	80	3	157	951	1620	2200	30,8	<b>WJ+WJP129/240 TN</b>
	250	80	3	158	1028	1660	2200	37,8	<b>WJ+WJP130/250 F</b>
<b>140</b>	250	80	3	160	1028	1660	2200	37,7	<b>WJ+WJP130/250 M</b>
	250	80	3	158	1028	1660	2200	34,3	<b>WJ+WJP130/250 TN</b>
	260	86	3	164	1212	1932	2000	44,4	<b>WJ+WJP130/260 M6</b>
<b>140</b>	300	102	4	180	1554	2460	1800	71,6	<b>WJ+WJP140/300 M</b>
<b>160</b>	320	102	4	200	1630	2676	1500	81,6	<b>WJ+WJP160/320 M</b>



## Cylindrical Roller Bearings, single row

### Non standardized

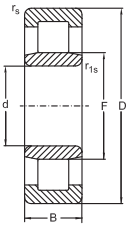

fig. 1

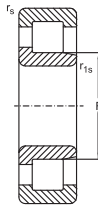

fig. 2

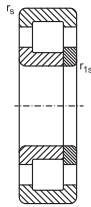

fig. 3

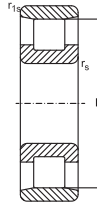

fig. 4

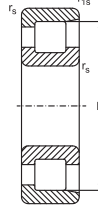

fig. 5

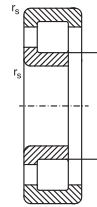

fig. 6

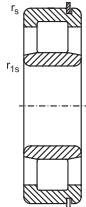

fig. 7

Dimensions						Fig.	Basical radial load		Speed Limit		Mass	Designation
d	D	B	r <sub>s</sub> min.	r <sub>1s</sub> min.	E, F		dyn. C <sub>r</sub>	stat. C <sub>or</sub>	grease	oil		
mm							KN		min <sup>-1</sup>			
<b>20</b>	47	14	1	0,6	40	5	15,4	12,7	13000	16000	0,11	<b>NF204</b>
	52	15	1	0,6	44,5	5	21,1	17,1	12000	15000	0,152	<b>NF304 M</b>
	52	21	1,1	0,3	25,77	1	49,7	45,3	12000	15000	0,21	<b>ZRL2443</b>
<b>25</b>	62	17	1,1	2,1	34	2	41,2	37	10000	13000	0,243	<b>NJ305 EC3WB133</b>
<b>30</b>	67	16	0,6	1	38,5	3	23,4	21,5	10000	12500	0,296	<b>NUP5806</b>
	67	16	0,6	1	38,5	3	23,4	21,5	10000	12500	0,296	<b>NUP5806 NA</b>
	72	19	1,1	1,1	62	4	38,6	35,2	8500	10000	0,346	<b>N306 F2</b>
<b>32</b>	72	19	1,5	1,5	61,8	5	55,5	56,8	8000	9500	0,37	<b>NF5306 NV</b>
<b>35</b>	80	21	1,5	1,1	68,2	5	44,3	40,4	7500	9000	0,5	<b>NF307</b>
<b>40</b>	80	18	1,1	1,1	70	5	43,7	42,9	7500	9000	0,42	<b>NF208</b>
	90	23	1,5	1,5	77,5	5	56,2	45,3	6300	7500	0,66	<b>NF308</b>
<b>45</b>	85	19	1,1	1,1	75	5	45,5	47,8	7500	9000	0,445	<b>NF209 M</b>
	100	25	1,5	1,5	86,5	5	72	70,5	6000	7000	0,895	<b>NF309</b>
	100	25	1,5	1,5	58,5	6	72	70,5	6000	7000	0,87	<b>NUPJ309</b>
	100	25	1,5	1,5	58,5	6	98	100	6000	7000	0,895	<b>NUPJ309 E</b>
	100	25	1,5	1,5	58,5	13	98	100	6000	7000	0,895	<b>NUPJ309 ENMAZS</b>
	100	36	2	1,5	86,5	5	98,5	114	6000	7000	1,45	<b>NF2309 M</b>
<b>50</b>	80	19	1	1	57,5	1	40,7	59,1	8000	9500	0,373	<b>NU2010 EMA6R35-50NAS1</b>
	90	20	1,1	1,1	80,4	5	48,2	51	6700	8000	0,52	<b>NF210</b>
	90	20	1,1	1,1	80,4	5	48,2	51	6700	8000	0,66	<b>NF210 M</b>
	90	20	1,1	1,1	59,5	6	64,4	68,3	6700	8000	0,49	<b>NUPJ210 EMA</b>
	90	23	1,1	1,1	60,4	3	61,8	70,2	6700	8000	0,61	<b>NUP2210</b>
	110	44,5	2	2	62	3	125	163	5300	6300	2,28	<b>NUP5410 MA</b>
	110	27	2	2	95	5	86,9	86,2	8500	6500	1,2	<b>NF310</b>
<b>55</b>	100	21	1,5	1,1	88,5	5	57,9	62,5	6300	7500	0,665	<b>NF211</b>
	100	21	1,5	1,1	88,5	5	57,9	62,5	6300	7500	0,68	<b>NF211 M</b>
	110	22	2,5	2,5	72	2	93,4	102	5000	6000	0,91	<b>NJ5111 E</b>
	120	29	2	2	70,5	6	109	109	5000	6000	1,47	<b>NUPJ311</b>
	120	29	2	2	70,5	6	134	140	5000	6000	1,51	<b>NUPJ311 E</b>
	120	29	2	2	70,5	13	134	140	5000	6000	1,47	<b>NUPJ311 ENMA</b>
	120	29	2	2	104,5	5	109	109	5000	6000	1,5	<b>NF311</b>
	120	29	2	2	104,5	5	109	109	5000	6000	1,66	<b>NF311 M</b>
<b>57.15</b>	114,3	28	1,5	1,5	99,6	5	84,5	88,7	5000	6000	1,45	<b>NF5211 MB</b>



### Cylindrical Roller Bearings, single row Non standardized

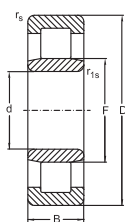

fig. 1

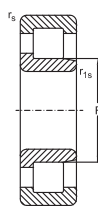

fig. 2

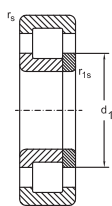

fig. 3

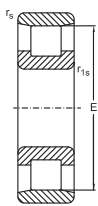

fig. 4

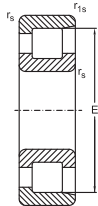

fig. 5

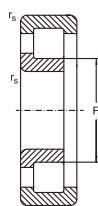

fig. 6

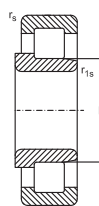

fig. 7

Dimensions						Fig.	Basical radial load		Speed Limit		Mass	Designation
d	D	B	r <sub>s</sub> min.	r <sub>1s</sub> min.	E, F		dyn. C <sub>r</sub>	stat. C <sub>0r</sub>	grease	oil		
mm							KN		min <sup>-1</sup>			
65	110	28	1,5	1,5	73,5	2	133	161	5600	6700	1,12	NJ65x110x28 EM
	120	23	1,5	1,5	105,6	5	80,5	89,7	5300	6300	1,05	NF213
70	125	31	1,5	1,5	83,5	3	156	196	4800	5600	1,17	NUP2214 EW7
	125,5	31	1,5	1,5	83,2	2	156	196	4800	5600	2	NJ2214 EM/D125,5
	150	35	2,1	2,1	89	13	205	222	4000	4800	2,8	NUPJ314 EN
	150	35	2,1	2,1	89	13	205	222	4000	4800	2,8	NUPJ314 ENMA
	150	35	2,1	2,1	89	13	205	222	4000	4800	2,8	NUPJ314 ENMAZS
	150	35	2,1	2,1	89	6	205	222	4000	4800	2,73	NUPJ314 EMA
75	130	25	1,5	1,5	116,5	5	92,5	106	4800	5600	1,27	NF215
80	140	26	2	2	125,3	5	106	122	4300	5000	1,59	NF216
	140	26	2	2	125,3	8	106	122	4300	5000	1,54	NP216
	140	26	2	2	127,3	8	140	170	4300	5000	1,81	NP216 EM
	140	26	2	2	127,3	6	140	170	4300	5000	1,51	NUPJ216 E
	140/ 147,8	26	2	2	95,3	14	139	166	4300	5000	1,85	484416
90	160	30	2	2	143	5	156	185	3800	4500	2,46	NF218
	190	43	3	3	165	5	237	261	3200	3800	5,81	NF318
	190	43	2,1	2,1	115	6	237	261	3200	3800	5,38	NUPJ318 M
95,25	133,35	19,05	1,5	1,1	123	4	60,9	83,7	3600	4300	0,85	N5319 MBP5

## Cylindrical Roller Bearings, single row

### Non standardized

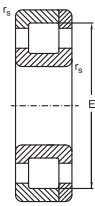

fig. 8

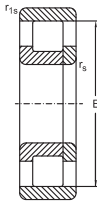

fig. 9

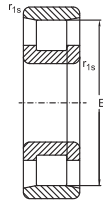

fig. 10

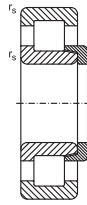

fig. 11

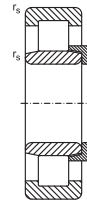

fig. 12

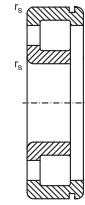

fig. 13

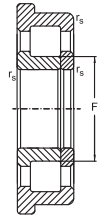

fig. 14

Dimensions						Fig.	Basical radial load		Speed Limit		Mass	Designation
d	D	B	r <sub>s</sub> min.	r <sub>1s</sub> min.	E, F		dyn. C <sub>r</sub>	stat. C <sub>0r</sub>	grease	oil		
mm							KN		min <sup>-1</sup>			
<b>99,5</b>	180	46	2,1	2,1	120	2	270	360	3000	3600	5,32	<b>NJ2220 MF2</b>
<b>100</b>	125	13	1	0,6	106,5	2	34	55,3	3600	4300	0,382	<b>NJ1820 M</b>
	180	34	2,1	2,1	120	8	181	215	3200	3800	3,44	<b>NP220 M</b>
	215	47	3	3	185,5	9	295	332	3000	3600	8,525	<b>NP320 M</b>
	215	73	3	3	127,5	1	570	720	2600	3200	12	<b>NU2320 EMW33</b>
	215	73	3	3	129,5	1	457	584	2600	3200	12	<b>NU2320 MAW33</b>
	215	73	3	3	129,5	1	457	584	2600	3200	13,1	<b>NU2320 MW33</b>
	215	73	3	3	129,5	1	457	584	2600	3200	12	<b>NU2320 W33</b>
	215	73	3	3	127,5	12	570	720	2600	3200	12	<b>NUJ2320 EM</b>
	215	47	3	3	185,5	10	310	354	2800	2400	8,67	<b>NP5220 MNA</b>
	215	47	4	4	127	11	384	432	3100	3900	10,53	<b>MR-320-129</b>
<b>110</b>	170	22	1	1	125	1	87,3	120,5	3600	4500	1,96	<b>NU110X170X22 MA6</b>
	170	100	1,1	1,1	125	1	140	190	3600	4500	3,8	<b>NU1022/B100 M</b>
<b>112</b>	170	38	2	1	127	1	181	264	3000	3600	3,15	<b>NU5120</b>
<b>120</b>	260	106	3	3	226	5	855	1168	2200	2800	28,06	<b>NF3324 M</b>
<b>130</b>	165	22	1	1	155,55	6	78,1	146	3300	4100	1,21	<b>N5126 MB</b>
	165	22	2	1	155,5	6	78,1	146	3300	4100	1,2	<b>2002826 LM</b>
	200	42	1,1	1,1	147	1	292	435	3000	3600	5,62	<b>NU2026 EM</b>



## Cylindrical Roller Bearings, single row Non standardized

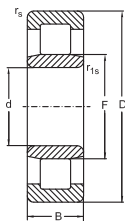

fig. 1



fig. 2

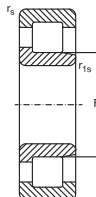

fig. 3

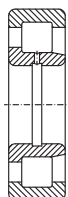

fig. 4

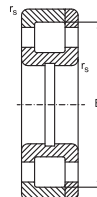

fig. 5

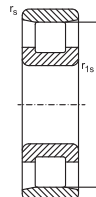

fig. 6

Dimensions						Fig.	Basical radial load		Speed Limit		Mass	Designation
d	D	B	r <sub>s</sub> min.	r <sub>1s</sub> min.	E, F		dyn. C <sub>r</sub>	stat. C <sub>0r</sub>	grease	oil		
mm							KN		min <sup>-1</sup>		kg	
<b>150</b>	225	45	2,1	1,5	168,5	1	338	527	2600	3200	6,49	<b>NU2030 EMC3ZS</b>
<b>152,4</b>	203,2	25,4	3	3	192,675	6	162	236	2600	3200	2,122	<b>60RIN247</b>
<b>160</b>	240	25	1,5	1,5	216	6	169	259	2200	2800	4,31	<b>NG160 M</b>
	240	48	1,5	1,5	179	1	382	609	2200	2800	7,85	<b>NU2032 EM</b>
	310	102	4	4	197	2	904	1283	1800	2200	36,94	<b>NJ160x310 M</b>
	310	102	4	4	197	3	904	1282	1800	2200	36,91	<b>NJP160x310 M</b>
<b>165,1</b>	279,4	39,687	2	1,5	188,1	3	424	516	2200	2800	10,9	<b>65RIT292</b>
<b>180</b>	280	31	1,5	1,5	250,1	6	258	401	2200	2800	7,71	<b>NG180 M</b>
	320	52	4	4	282	8	516	717	1800	2200	18,8	<b>NF236 M</b>
<b>190</b>	290	60	2,1	2,1	214	1	616	561	1800	2200	14,8	<b>NU2038 EMC3ZS</b>
<b>200</b>	310	66	2,1	2,1	229	6	553	912	1800	2200	18,96	<b>NU2040 M</b>
<b>220</b>	340	56	3	3	250	3	650	1047	1700	2000	19,3	<b>NJ1044 B/M/R204</b>
	400	65	4	4	270	16	778	1113	1500	1800	41,6	<b>NUJ244 M</b>
<b>240</b>	319,975	48	2	1,5	300	6	405	736	1500	1800	10,7	<b>N5248 MBP5NA</b>
	320	48	2	2	261	1	361	684	1500	1800	11,2	<b>NU2948 MAP63</b>
<b>253,94</b>	380	70	5	5	286	3	803	1368	1400	1700	29,39	<b>51NJ3870 M</b>
<b>300</b>	380	48	3	2,1	321	2	479	988	1300	1600	14,3	<b>NJ2860 EMA</b>
<b>305</b>	460	65	5	5	422	7	884	1418	1400	1700	38,775	<b>N10/305 NA</b>
<b>330,2</b>	438,15	69,85	6	6	353,425	1	990	1935	1300	1600	29,8	<b>NU131725 MA</b>
<b>381</b>	508	63,5	4	4	406,5	3	951	1688	1200	1400	37	<b>NJ5176 MW33</b>
<b>406,4</b>	574,675	127	4	4	533	6	1907	3970	1000	1300	106,47	<b>81N57127 W33</b>

## Cylindrical Roller Bearings, single row

### Non standardized

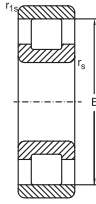

fig. 7

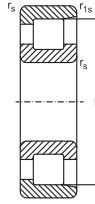

fig. 8

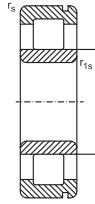

fig. 9

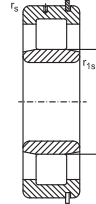

fig. 10

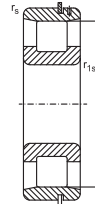

fig. 11

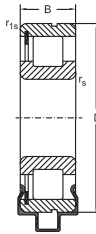

fig. 12

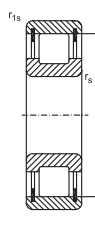

fig. 13

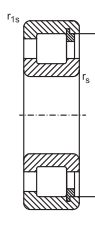

fig. 14

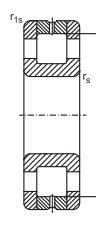

fig. 15

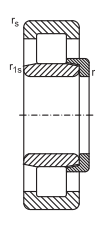

fig. 16

Dimensions						Fig.	Basical radial load		Speed Limit		Mass	Designation
d	D	B	r <sub>s</sub> min.	r <sub>1s</sub> min.	E, F		dyn. C <sub>r</sub>	stat. C <sub>or</sub>	grease	oil		
mm							KN		min <sup>-1</sup>		kg	
25	67	15	0,6	0,6	31,5	10	29,3	27,7	10400	13000	0,317	<b>NU5305 ENR</b>
	67	15	1	0,6	53,5	11	23,4	21,5	10400	13000	0,267	<b>N5805 NR</b>
	67	15	1	0,6	53,5	11	23,4	21,5	10400	13000	0,267	<b>N5805 NRC3NA</b>
30	62	24	1	1	54	13	44,2	47	8000	10000	0,32	<b>N2R5706</b>
	67	16	1	0,6	53,5	11	23,4	21,5	10000	12500	0,274	<b>N5806 NRP6</b>
	67	15	1	0,6	53,5	11	23,4	21,5	10000	12500	0,27	<b>N5806 NRP6F2</b>
35	67	16	1	0,6	53,5	11	23,4	21,5	10000	12500	0,274	<b>N5806 NRP6NA</b>
	72	27	1	1	62,5	13	63,7	72,5	7000	8500	0,524	<b>N2R5207</b>
40	80	23	1,5	0,6	49,5	9	58	61	6300	8000	0,613	<b>NUC5107 NM</b>
	90	23	1	1	78	13	71,8	70,3	5600	7000	0,743	<b>N2R308</b>
	90	23	1,6	1,6	77,663	13	72	71,4	5600	7000	0,72	<b>482208</b>
<b>55</b>	140	57	2	2	117,2	15	175	392	1400	2000	4,8	<b>N2P5611 MBW33</b>
<b>70</b>	150	35	2,1	2,1	129,3	13	173	188	3400	4000	2,95	<b>N2R314</b>
<b>80</b>	140	26	2	2	125,3	14	116	138	1600	2000	1,677	<b>NFR216</b>
<b>120</b>	215	40	2,1	2,1	191,5	14	284	358	1100	1400	6,164	<b>NFR224</b>



## Single Row Full Complement Cylindrical Roller Bearings Non standardized

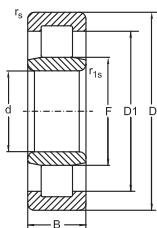

fig. 1

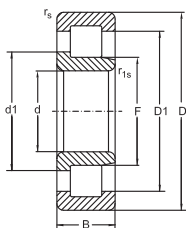

fig. 2

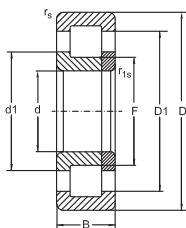

fig. 3

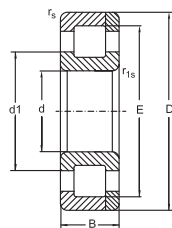

fig. 4

Dimensions					Basical radial load		Speed Limit		Fig.	Designation
d	D	B	r <sub>s</sub> min.	r <sub>is</sub>	dyn. C <sub>r</sub>	stat. C <sub>gr</sub>	grease	oil		
mm					KN		min <sup>-1</sup>			
25	62	24	1,1	1,1	64,2	62,1	3000	5300	1	<b>NU2305 VH</b>
	62	17	1,1	1,1	39,3	37,5	3000	5300	5	<b>N2R305 V</b>
30	61,935	23,813	1,1	1,1	65,4	78,7	2600	4900	5	<b>471606 V</b>
	62	16	1	1	41,7	50,7	2600	4900	4	<b>NP206 EV</b>
	62	19	1	1	51,4	57,7	2600	4900	5	<b>N2R5906 V</b>
	80	21	1	1	73,9	84,5	3000	3600	5	<b>N2R5206 V</b>
32	72	19	2	1,5	55,5	56,8	1900	4200	6	<b>NF5306 NV</b>
34,991	72	20,638	1,6	4	67,6	77,6	1900	4000	7	<b>482307 V</b>
35	62	14	1	0,6	34,3	36,2	2600	5000	1	<b>NU1007 V</b>
	72	23	0,6	1,6	68,7	75,7	1900	4000	5	<b>N2R2207 V</b>
40	80	18	1,4	1	61	62,6	1800	3400	5	<b>N2R5108 V</b>
45	85	19	1	1	59,7	66,1	1400	3000	5	<b>N2R209 V</b>
	85	23	1,1	1,1	80	96,5	1400	3000	5	<b>N2R2209 V</b>
	85	25	0,6	0,6	104	120	1800	3500	3	<b>NUP45X85X25 V</b>
	100	25	1,6	1,6	110	111	1400	2800	5	<b>N2R309 V</b>
	100	25	1,7	1,7	114	121	1400	2800	2	<b>NJ309 EVH</b>
50	80	15	1	1	41,5	51,2	1600	3400	5	<b>N2R510 V</b>
	90	23	0,6	0,6	91,1	98,4	1600	3400	3	<b>NUP2210 VH</b>
	90	27	1,1	1,1	113	130	1600	3400	3	<b>471510 VH</b>
55	120	29	2	2	150	160	1600	3400	3	<b>NUP311 VH</b>
60	130	31	2,1	2,1	175	194	1100	2400	3	<b>NUP312 VH</b>
65	140	33	3	1,5	152	163	1000	2200	5	<b>N2R5613 VC4</b>
	140	33	3	1,5	197	231	1000	2200	7	<b>NFR5113 VC4</b>
90	160	52,4	2	2	340	508	900	1800	2	<b>NJ5218 VH</b>
	180	60,3	2,1	2,1	414	631	1200	1500	2	<b>NJ5220 VC3</b>
130	230	64	3	3	591	853	600	1200	2	<b>NJ130X230X64 V</b>

## Single Row Full Complement Cylindrical Roller Bearings

Non standardized

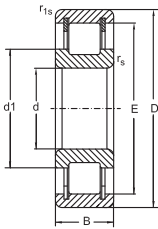

fig. 5

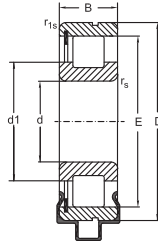

fig. 6

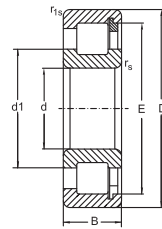
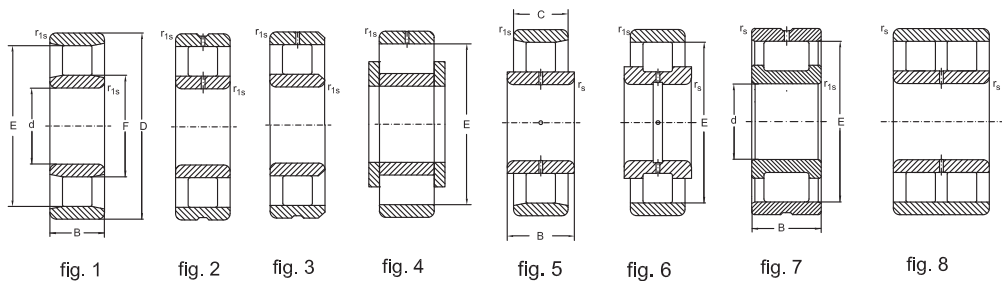

fig. 7

Dimensions				Mass Bearing
d ≈	E, F ≈	D <sub>1</sub> ≈	d <sub>1</sub> ≈	
mm				Kg
<b>25</b>	31,74	48,2	-	0,372
	53	-	39,5	0,277
<b>30</b>	54,5	-	41,6	0,34
	37,5	50,6	41,8	0,225
	54,5	-	42,2	0,266
	61,8	-	51,1	0,578
<b>32</b>	61,8	-	46	0,37
<b>34,991</b>	62,471	59,5	48,15	0,404
<b>35</b>	40,7	52,7	-	0,16
	64,7	-	48,2	0,32
<b>40</b>	71,5	-	55,2	0,403
<b>45</b>	74,2	-	60,1	0,484
	74,2	-	59,6	0,602
	53,4	71	59,8	0,639
	88,25	-	62,5	0,94
	57,31	73,5	63,8	0,953
	72,5	-	61,2	0,267
<b>50</b>	57,8	76	65,6	0,632
	57,8	76,9	65	0,735
<b>55</b>	68,75	97,8	77,4	1,674
<b>60</b>	78,54	106	86,5	2,147
<b>65</b>	121,3	-	91,5	2,43
	121,3	104	91,5	2,6
<b>90</b>	108,55	133,8	114,5	4,664
	120,6	150	129	6,684
<b>130</b>	152	196,8	163,2	11,11

## Cylindrical Roller Bearings Non standardized



Dimensions								Fig.	Basical radial load		Speed Limit		Mass Bearing	Designation
d	D	B	C	$r_s$	$r_{1s}$ min.	E	F		dyn. $C_r$	stat. $C_{gr}$	grease	oil		
mm									KN		min <sup>-1</sup>		Kg	
<b>50,8</b>	110	45,3	44,5	2	1,5	95,5	65,5	6	164	195	4300	5600	2,114	<b>NB5210 S3W44</b>
<b>58</b>	96	51,6	43,6	1,5	1,5	86	68	4	160	146	4300	6000	1,3	<b>NUN5212</b>
	96	51,6	43,6		0,3		68	4	159	264	6400	8000	1,378	<b>NUN5212 FC3</b>
	96	51,6	43,6	1,3	1,3	86	68	5	160	146	4300	6000	1,38	<b>NUNB5212 FC3</b>
<b>65</b>	120	52,4		1,5	0,6	104,8	79,7	1	203	298	3600	4800	2,6	<b>NUN5613</b>
<b>70</b>	125	60,3		1,5	0,6	109,6	84,1	1	229	353	3400	4500	3,1	<b>NUN5114</b>
<b>80</b>	140	46		2	0,6	122,3	93,7	1	208	297	3000	4000	2,98	<b>NUN5216</b>
	140	66,6		2	2	123,8	95,2	1	329	541	3000	4000	4,44	<b>NUN5716 F2</b>
<b>85</b>	150	49,2		2	2	133,4	101,6	1	272	359	2800	3800	3,82	<b>NUN3217 W20</b>
<b>95</b>	170	55,6		3	2,1	151,1	113,5	1	363	536	2600	3400	5,16	<b>NUN2R3219 F2</b>
	170	55,6		3	2,1	151,1	113,5	1	363	536	2600	3400	5,67	<b>NUN3219 W20F2</b>
<b>101,6</b>	139	76,2		2	1,5	139,6	114,2	1	358	685	2800	3800	4,74	<b>NUN5320 W33F2</b>
<b>130</b>	230	110		2	2	206	154	8	728	1159	2400	3000	20,2	<b>2NUN5226 MW3</b>
<b>152,4</b>	209,55	53,975		1,25	2,5	165	165	3	345	626	2600	3300	5,7	<b>B6460</b>
<b>180</b>	320	149				285	215	1	1512	2670	2000	2500	51,95	<b>NUN5136 M</b>
<b>285,75</b>	387,35	69,85		2,5	2,5	368	318	2	743	1534	1400	1800	23,933	<b>491357 M</b>
	387,35	69,85		2,5	2,5	368	318	7	748	1534	1400	1800	24,723	<b>491457 M</b>
<b>345</b>	406	28			1,5		362	1	215	486	1300	1600	7,215	<b>NUN5169 M</b>



## Combined Cylindrical Roller Bearings and Thrust Bearings

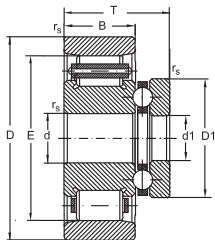

Fig.1

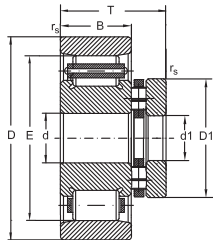

Fig.2

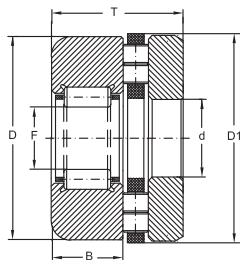

Fig.3

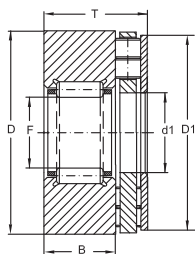

Fig.4

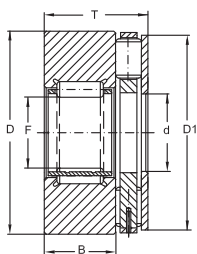

Fig.5

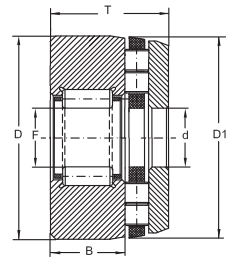

Fig.6

Dimensions									Fig.	Basic radial load		Basic axial load		Mass Bearing	Designation
d	d1	D	D1	B	T	r <sub>s</sub>	r <sub>1s</sub> min.	E, F		dyn. C <sub>r</sub>	stat. C <sub>or</sub>	dyn. C <sub>a</sub>	stat. C <sub>0a</sub>		
mm										KN				Kg	
-	40	86	80	14	27	-	-	32	6	27	24	101	414	0,733	<b>969608</b>
-	40,02	78	78	14	27	-	-	40,025	3	30	33	96,9	388	0,574	<b>960508</b>
-	40,05	78	77,6	14	23	-	-	40,025	4	26,5	29,7	96,9	388	0,47	<b>963208</b>
-	40,05	90	87	12	24	-	-	40,025	4	14,2	21,2	181	474	0,87	<b>964708</b>
-	40,05	82,5	77,6	10,5	19,5	-	-	40,05	4	13,9	20,5	96,9	388	0,46	<b>963108</b>
-	70,5	112	104,5	14	30	-	-	40,025	5	26,4	34,9	182	597	1,525	<b>962509</b>
-	50,2	114,4	103	17	33	-	-	50	6	39,8	53,7	209,8	798,6	1,55	<b>963510</b>
<b>139,725</b>	136,525	228,6	184,125	31,75	57,277	2,5	2,5	207,75	1	216	354	121,6	107	7,243	<b>53RRT01</b>
<b>177,8</b>	172,08	323,85	254	44,45	84,09	2,1	2,1	298,45	2	384	596	591	2581	24,31	<b>70TPCM340</b>
<b>177,85</b>	174,625	292,1	231,75	44,45	73,15	3	3	258,1	1	308	541	163	155,7	15,7	<b>68RRT01</b>



### Cylindrical Roller Bearings, single row Non standardized

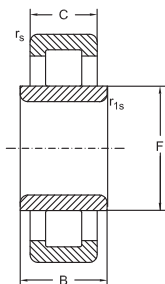

fig. 1

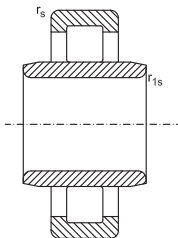

fig. 2

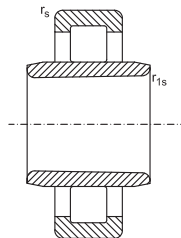

fig. 3

Dimensions							Fig.	Basical radial load		Speed Limit		Mass Bearing	Designation
d	D	B	C	r <sub>s</sub>	r <sub>1s</sub> min.	E, F		dyn. C <sub>r</sub>	stat. C <sub>or</sub>	grease	oil		
mm								KN		min <sup>-1</sup>		Kg	
20	47	18	14	1	0,6	26,5	2	25,7	22,6	15000	18000	0,112	NUB204 E
25	52	18	15	1	0,6	31,5	2	29,3	27,7	12000	15000	0,14	NUB205 E
	62	24	17	1,1	1,1	34	2	41,2	37	10000	13000	0,243	NUB305 E
30	62	20	16	1	0,6	37,5	2	39,7	37,9	10000	13000	0,24	NUB206 E
40	80	23	18	1,1	1,1	49,5	2	53,1	52,1	8000	9500	0,47	NUB208 E
	80	23	18	1,1	1,1	49,5	3	53,1	52,1	8000	9500	0,47	NUB208 EK
45	85	23	19	1,1	1,1	54,5	2	61,7	64,6	7500	9000	0,46	NUB209 E
50	90	23	20	1,1	1,1	59,5	2	63,7	68,3	6700	8000	0,52	NUB210 E
	90	40	20	2	1,5	60,4	2	47,8	50,4	6000	7000	0,641	NUB5110 NA
60	110	28	22	1,5	1,5	72	2	94	102,3	5600	6700	0,93	NUB212 E
65	120	31	23	1,5	1,5	78,5	2	108	119	5300	6300	1,18	NUB213 E
	120	48	23	1,5	1,5	79,6	2	105	115	4800	5600	1,39	NUB5313 NA
	140	49	33	2,1	2,1	83,5	2	134	137	4000	4800	2,52	NUB5213 NA
	140	66	33	2	2	83,5	1	135	139	4800	6000	2,82	NUB5413 NA
75	130	31	25	1,5	1,5	88,5	2	130	156	4800	5600	1,39	NUB215 E
	160	55	37	2,1	2,1	95	2	239	261	3800	4600	3,7	NUB315 E
85	150	54	28	2	2	101,8	2	121	141	4300	5000	1,89	NUB217
	150	36	28	2	2	100,5	2	164	194	4300	5000	1,89	NUB217 E
170	310	76	52	4	4	208	2	499	677	1300	1800	21,4	NUB234 MAC3F2
	310	116	86	4	4	208	2	784	1141	1700	2000	31,9	NUB2234 MC3

## Split Cylindrical Roller Bearings, single row

Non standardized

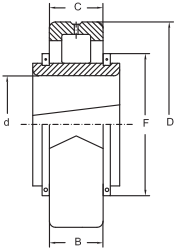

fig. 1

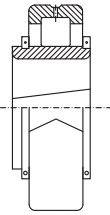

fig. 2

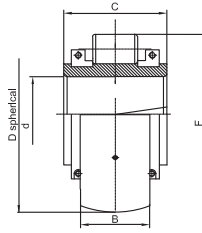

fig. 3

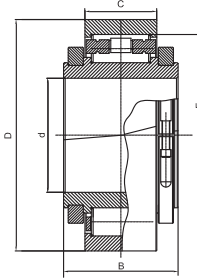

fig. 4

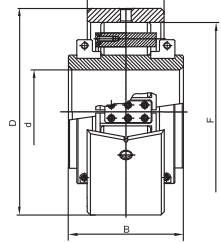
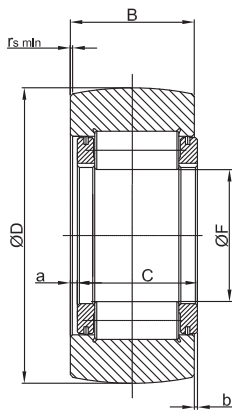

fig. 5

Dimensions					Fig.	Basical radial load		Speed Limit	Mass Bearing	Designation
d	D	B	C	F		dyn. $C_r$	stat. $C_{or}$	grease		
mm						KN		min <sup>-1</sup>	Kg	
<b>127</b>	254	114,3	63,5	193	1	570	745	1800	22	<b>NUBS5125 MA</b>
<b>130</b>	222,25	98,5	54	180	4	367	503	1740	12,3	<b>NBS5126 M</b>
<b>145</b>	250	80	117,5	225	3	865	1658	1500	18,9	<b>493829 VC4NAS1</b>
<b>220</b>	393,757	156	90,5	324,2	2	1156	1680	850	73,6	<b>NUBS5144 MA</b>
<b>300</b>	438	143	74,5	388	5	850	1549	650	58,7	<b>NBS5160 MC3NA</b>
	438	143	74,5	388	2	850	1549	650	59,4	<b>NUBS5160 M</b>



## Cylindrical Roller Bearings Non standardized



Dimensions							Basic radial load		Mass	Designation
D	F	B	C	$r_s$ min	a	b	Dynamic $C_r$	Static $C_{or}$		
mm							kN		Kg	
<b>170</b>	80,03	60	57,5	1x45°	4	1,5	219,2	292,4	7,8	<b>482916 VHS0</b>

# URB





# Double Row Cylindrical Roller Bearings

## Standards, Boundary dimensions

Standard plans                   DIN 616  
 Double row cylindrical roller bearings,  
   DIN 5412 / part 4

## General

Double Row Cylindrical Roller Bearings of series NN30 and NNU 49 are separable radial bearings.

They are frequently used as non – locating bearings arrangements of working spindles for machine tools. Therefore, these bearings are often used in high precision tolerance class, frequently in combination with reduced internal clearance. These bearings also feature high radial load capacity and are satisfactory for high speed applications, providing a very stiff and rigid bearing arrangement. They are also commonly used with tapered bores, namely suffix K, (i.e. taper 1:12).

## Design variants of Double Row Cylindrical Roller Bearings

Double Row Cylindrical Roller Bearings of series NN 30.. and NNU 49.. are produced and available either with or without tapered bores, as standard (see also figure below).

Bearings of series NN 30.. comprise of a plain outer ring and an inner ring with three integral shoulders to guide the two separate rows of rollers around the raceway. These bearings series are produced with lubrication facilities in their outer ring, such as a circumferential lubrication groove and holes as standard, name suffix W33.

Unlike the NN30.. series the double row cylindrical roller bearings of the NNU 49.. series feature opposite internal design characteristics, (i.e. outer ring with 3 integral shoulders around the raceway and a plain inner ring). These bearing series also feature lubrication facilities in their outer ring as standard, also namely, suffix W33.

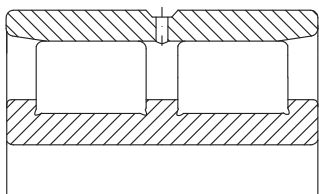

**NN30..W33**

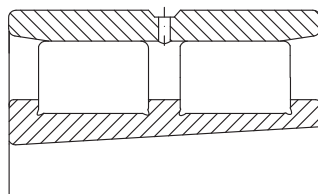

**NN30..K..W33**

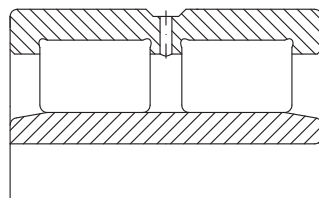

**NNU49..W33**

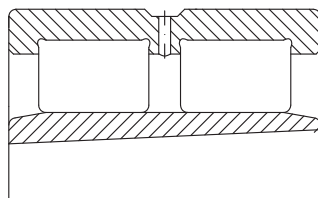

**NNU49..K..W33**



Cylindrical roller bearings of series NN30.. and NNU49.. allow for compensation of length changes within the bearings itself. In this way they are ideal non-locating bearings.

Both bearing rings may be mounted with heavy interference fit to shaft and housing.

### Misalignment

Double Row Cylindrical Roller bearings are not able to accommodate misalignments.

### Tolerances

**Double Row Cylindrical Roller Bearings of series NN 30.. and NNU 49..** are frequently used as spindle bearings.

Consequently, they are also available with closer tolerance classes, such as P4 or SP, as standard.

On request these bearings are also produced to other tolerance classes.

Detailed tolerance values, for URB double row cylindrical roller bearings and URB double row cylindrical roller bearings in spindle bearing design, tolerance class SP, are listed in the table shown in the chapter "Bearing tolerances" page 25.

### Cages

URB Double Row Cylindrical Roller Bearings of the series NN 30.. and NNU 49.. are produced with roller riding solid brass cages as standard.

### Internal clearance

**URB Double Row Cylindrical Roller Bearings** are produced with normal internal clearance (clearance group CN, historically designated C0) as standard. Other internal radial clearances are produced upon order request.

#### NOTE:

#### **URB Double Row Cylindrical Roller Bearings**

of series NN 30.. and NNU 49.. produced to high precision design are frequently used with reduced internal radial clearance (clearance group C1).

As these bearings are produced to very closed tolerances, under no circumstances should components be mixed or exchanged with other bearing parts.

The value of internal clearance groups of URB Cylindrical Roller Bearings are listed in the tables on pages 155-156.

These Values conform, as far as they are standardised, and conform to DIN 620/part 4 and ISO 5753-1, respectively.

### Minimum load

The minimum load applied to fast rotating double row cylindrical roller bearings should be higher than 4 % of its dynamic load rating  $C_r$ .

### Equivalent Dynamic bearing load

Since double Row Cylindrical Roller Bearings of series NN 30.. and NNU 49.. are non – locating bearings, they are not able to accommodate any thrust loads.

$$P = F_r$$

### Equivalent static bearing load

For Single and Double row cylindrical roller bearings:

$$P_0 = F_r$$

### Mounting

When handling High Precision double row cylindrical roller bearings particular attention must be paid to the relevant instructions of fitting and mounting of these bearings.

When double row cylindrical roller bearings, with



tapered inner bores, are mounted the effect on the running clearance can be adjusted to obtain a specific clearance or preload.

As these bearing types are separable under no circumstances should either components or assembled bearings be mixed or exchanged with other bearing parts.

**Abutment and fillet dimensions for Double row cylindrical roller bearings**

The bearing rings must only contact adjacent parts with their side faces. The bearing corners must not touch the corner fillet radii or either the shaft or housing corners.

Therefore, the largest fillet radius ( $r_g$ ) must be smaller than the minimum fillet dimension of the bearings rings ( $r_s$ ) as listed in the bearing tables, also see next page.

Recommendations for the dimensions of adjacent parts are listed in **DIN 5418**.

**Abutment and fillet dimensions for Double Row Cylindrical Roller Bearings**

Dimensions are in [mm]

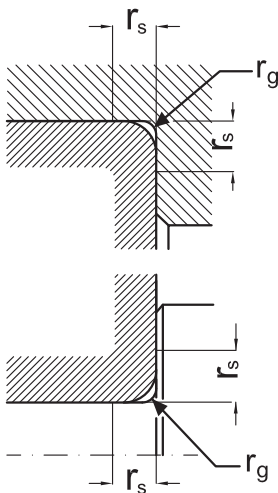



### Abutment dimension for Double row Cylindrical Roller Bearings

All dimensions are in [mm]

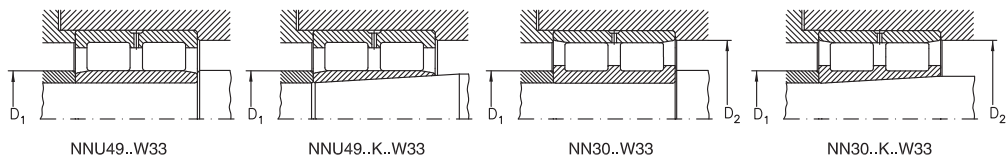

Shaft diameter	for Bearings series					
	NNU49, NNU49 K		NN30, NN30 K			
	Type	D1	Type	D1	D2	
max		min		min	max	
mm						
30	-	-	NN3006	35	49	50
35	-	-	NN3007	40	56	57
40	-	-	NN3008	45	62	63
45	-	-	NN3009	50	69	70
50	-	-	NN3010	55	74	75
55	-	-	NN3011	61	82	84
60	-	-	NN3012	66	87	89
65	-	-	NN3013	71	92	94
70	-	-	NN3014	76	102	104
75	-	-	NN3015	81	107	109
80	-	-	NN3016	86	115	119
85	-	-	NN3017	91	120	124
90	-	-	NN3018	98	129	133
95	-	-	NN3019	103	134	137
100	NNU4920	112	NN3020	108	139	142
105	NNU4921	117	NN3021	114	148	151
110	NNU4922	122	NN3022	119	157	161
120	NNU4924	133	NN3024	129	167	171
130	NNU4926	145	NN3026	139	184	191
140	NNU4928	155	NN3028	149	194	201
150	NNU4930	167	NN3030	160	208	215
160	NNU4932	177	NN3032	170	222	230
170	NNU4934	187	NN3034	180	239	250
180	NNU4936	200	NN3036	190	258	270
190	NNU4938	210	NN3038	200	268	280
200	NNU4940	223	NN3040	210	285	300
220	NNU4944	243	NN3044	232	313	328
240	NNU4948	263	NN3048	252	334	348
260	NNU4952	289	NN3052	275	368	385
280	NNU4956	309	NN3056	295	388	405
300	NNU4960	335	NN3060	315	422	445
320	NNU4964	335	NN3064	335	442	465

# URB





### Double Row Cylindrical Roller Bearings

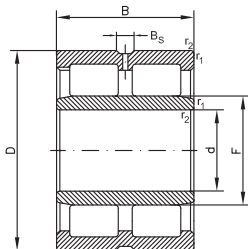

NNU49..W33

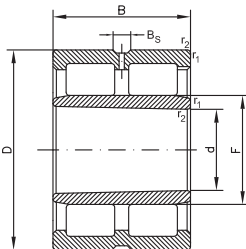

NNU49..K..W33

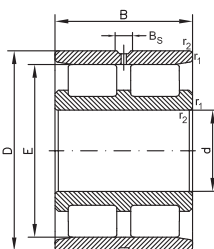

NN30..W33

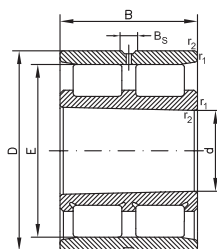

NN30..K..W33

d	Dimensions			Basical radial load		Speed limit		Designation
	D	B	r <sub>1</sub> , r <sub>2</sub> min.	dyn. C <sub>r</sub>	stat. C <sub>0r</sub>	grease	oil	
mm				kN		min <sup>-1</sup>		
30	55	19	1	29	34	16000	19000	NN3006 MW33
	55	19	1	29	34	16000	19000	NN3006 KMW33
35	62	20	1	39,3	50	14000	17000	NN3007 MW33
	62	20	1	39,3	50	14000	17000	NN3007 KMW33
40	68	21	1	45	58,5	12000	15000	NN3008 MW33
	68	21	1	45	58,5	12000	15000	NN3008 KMW33
45	75	23	1	54	72	11000	14000	NN3009 MW33
	75	23	1	54	72	11000	14000	NN3009 KMW33
50	80	23	1	57	80	10000	13000	NN3010 MW33
	80	23	1	57	80	10000	13000	NN3010 KMW33
55	90	26	1,1	72	100	9000	11000	NN3011 MW33
	90	26	1,1	72	100	9000	11000	NN3011 KMW33
60	95	26	1,1	75	110	8500	10000	NN3012 MW33
	95	26	1,1	75	110	8500	10000	NN3012 KMW33
65	100	26	1,1	76,5	118	8000	9500	NN3013 MW33
	100	26	1,1	76,5	118	8000	9500	NN3013 KMW33
70	110	30	1,1	98	151	7000	8500	NN3014 MW33
	110	30	1,1	98	151	7000	8500	NN3014 KMW33
75	115	30	1,1	100	156	6700	8000	NN3015 MW33
	115	30	1,1	100	156	6700	8000	NN3015 KMW33
80	125	34	1,1	120	186	6300	7500	NN3016 MW33
	125	34	1,1	120	186	6300	7500	NN3016 KMW33
85	130	34	1,1	125	200	6000	7000	NN3017 MW33
	130	34	1,1	125	200	6000	7000	NN3017 KMW33
90	140	37	1,5	141	224	5600	6700	NN3018 MW33
	140	37	1,5	141	224	5600	6700	NN3018 KMW33
95	145	37	1,5	146	236	5300	6300	NN3019 MW33
	145	37	1,5	146	236	5300	6300	NN3019 KMW33

## Double Row Cylindrical Roller Bearings

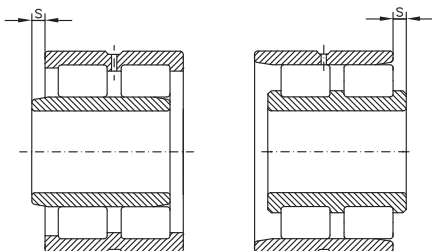

Abutment and fillet dimensions  
see on page 269-270

Bearing dimensions					Mass
d	E	F	B <sub>s</sub>	s	
mm					[kg]
30	48,5	-	4,8	1,4	0,12
	48,5	-	4,8	1,4	0,12
35	55	-	4,8	1,4	0,25
	55	-	4,8	1,4	0,25
40	61	-	4,8	1,4	0,33
	61	-	4,8	1,4	0,32
45	67,5	-	4,8	1,7	0,39
	67,5	-	4,8	1,7	0,38
50	72,5	-	4,8	1,7	0,42
	72,5	-	4,8	1,7	0,41
55	81	-	4,8	1,9	0,62
	81	-	4,8	1,9	0,60
60	86,1	-	4,8	1,9	0,67
	86,1	-	4,8	1,9	0,65
65	91	-	4,8	1,9	0,73
	91	-	4,8	1,9	0,71
70	100	-	6,5	2,3	1,03
	100	-	6,5	2,3	0,99
75	105	-	6,5	2,3	1,08
	105	-	6,5	2,3	1,05
80	113	-	6,5	2,5	1,51
	113	-	6,5	2,5	1,46
85	118	-	6,5	2,5	1,55
	118	-	6,5	2,5	1,50
90	127	-	6,5	2,5	2,15
	127	-	6,5	2,5	2,09
95	132	-	6,5	2,5	2,10
	132	-	6,5	2,5	2,03



### Double Row Cylindrical Roller Bearings

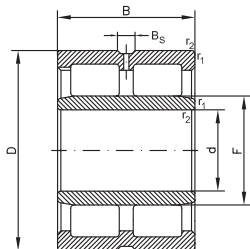

NNU49..W33

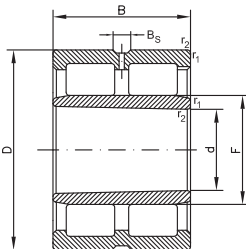

NNU49..K..W33

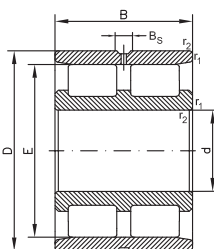

NN30..W33

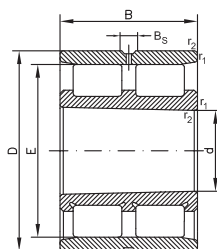

NN30..K..W33

d	Dimensions			Basical radial load		Speed limit		Designation
	D	B	r <sub>1</sub> , r <sub>2</sub> min.	dyn. C <sub>r</sub>	stat. C <sub>0r</sub>	grease	oil	
mm				kN		min <sup>-1</sup>		
100	140	40	1,1	129	255	5300	6300	NNU4920 MW33
	140	40	1,1	129	255	5300	6300	NNU4920 KMW33
	150	37	1,5	152	264	5300	6300	NN3020 MW33
	150	37	1,5	152	264	5300	6300	NN3020 KMW33
105	145	40	1,1	129	260	5300	6300	NNU4921 MW33
	145	40	1,1	129	260	5300	6300	NNU4921 KMW33
	160	41	2	192	310	4800	5600	NN3021 MW33
	160	41	2	192	310	4800	5600	NN3021 KMW33
110	150	40	1,1	132	270	5000	6000	NNU4922 MW33
	150	40	1,1	132	270	5000	6000	NNU4922 KMW33
	170	45	2	226	365	4500	5300	NN3022 MW33
	170	45	2	226	365	4500	5300	NN3022 KMW33
120	165	45	1,1	176	340	4500	5300	NNU4924 MW33
	165	45	1,1	176	340	4500	5300	NNU4924 KMW33
	180	46	2	235	405	4300	5000	NN3024 MW33
	180	46	2	235	405	4300	5000	NN3024 KMW33
130	180	50	1,5	193	390	4000	4800	NNU4926 MW33
	180	50	1,5	193	390	4000	4800	NNU4926 KMW33
	200	52	2	294	510	3800	4500	NN3026 MW33
	200	52	2	294	510	3800	4500	NN3026 KMW33
140	190	50	1,5	190	400	3800	4500	NNU4928 MW33
	190	50	1,5	190	400	3800	4500	NNU4928 KMW33
	210	53	2	305	520	3600	4300	NN3028 MW33
	210	53	2	305	520	3600	4300	NN3028 KMW33
150	210	60	2	326	655	3600	4300	NNU4930 MW33
	210	60	2	326	655	3600	4300	NNU4930 KMW33
	225	56	2	339	600	3400	4000	NN3030 MW33
	225	56	2	339	600	3400	4000	NN3030 KMW33

## Double Row Cylindrical Roller Bearings

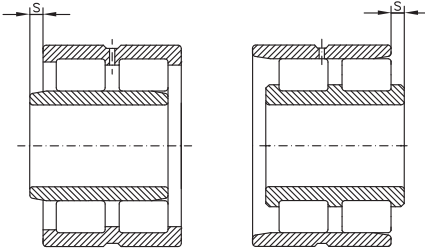

Abutment and fillet dimensions  
see on page 269-270

Bearing dimensions					Mass
d	E	F	B <sub>s</sub>	s	
mm					[kg]
100	-	113	6,5	2	1,80
	-	113	6,5	2	1,72
	137	-	6,5	2,5	2,20
	137	-	6,5	2,5	2,13
105	-	118	6,5	1,5	2,07
	-	118	6,5	1,5	1,98
	146	-	6,5	2,6	2,84
	146	-	6,5	2,6	2,75
110	-	123	6,5	1,5	2,13
	-	123	6,5	1,5	2,04
	155	-	6,5	2,8	3,68
	155	-	6,5	2,8	3,56
120	-	134,5	6,5	1,5	2,76
	-	134,5	6,5	1,5	2,64
	165	-	6,5	3,1	3,96
	165	-	6,5	3,1	3,83
130	-	146	6,5	2	3,54
	-	146	6,5	2	3,37
	182	-	9,5	3,35	5,75
	182	-	9,5	3,35	5,57
140	-	156	6,5	2	4,24
	-	156	6,5	2	4,06
	192	-	9,5	3,35	6,38
	192	-	9,5	3,35	6,18
150	-	168,5	6,5	2,3	6,49
	-	168,5	6,5	2,3	6,21
	206	-	9,5	3,7	7,50
	206	-	9,5	3,7	7,26



### Double Row Cylindrical Roller Bearings

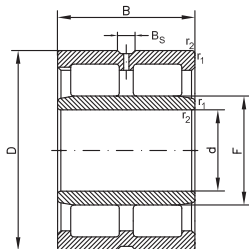

NNU49..W33

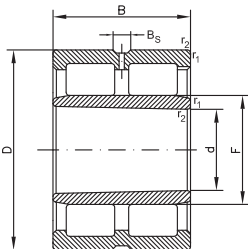

NNU49..K..W33

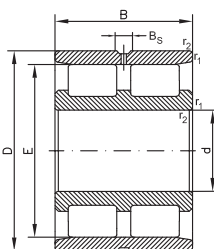

NN30..W33

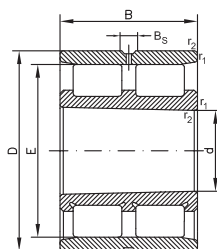

NN30..K..W33

d	Dimensions			Basical radial load		Speed limit		Designation
	D	B	r <sub>1</sub> , r <sub>2</sub> min.	dyn. C <sub>r</sub>	stat. C <sub>0r</sub>	grease	oil	
mm				kN		min <sup>-1</sup>		
160	220	60	2	335	680	3400	4000	NNU4932 MW33
	220	60	2	335	680	3400	4000	NNU4932 KMW33
	240	60	2,1	388	670	3200	3800	NN3032 MW33
	240	60	2,1	388	670	3200	3800	NN3032 KMW33
170	230	60	2	340	720	3200	3800	NNU4934 MW33
	230	60	2	340	720	3200	3800	NNU4934 KMW33
	260	67	2,1	458	810	3000	3600	NN3034 MW33
	260	67	2,1	458	810	3000	3600	NN3034 KMW33
180	250	69	2	405	877	3000	3600	NNU4936 MW33
	250	69	2	405	877	3000	3600	NNU4936 KMW33
	280	74	2,1	576	1080	2800	3400	NN3036 MW33
	280	74	2,1	576	1080	2800	3400	NN3036 KMW33
190	260	69	2	412	910	2800	3400	NNU4938 MW33
	260	69	2	412	910	2800	3400	NNU4938 KMW33
	290	75	2,1	614	1088	2600	3200	NN3038 MW33
	290	75	2,1	614	1088	2600	3200	NN3038 KMW33
200	280	80	2,1	490	1040	2600	3200	NNU4940 MW33
	280	80	2,1	490	1040	2600	3200	NNU4940 KMW33
	310	82	2,1	715	1271	2400	3000	NN3040 MW33
	310	82	2,1	715	1271	2400	3000	NN3040 KMW33
220	300	80	2,1	535	1321	2400	3000	NNU4944 MW33
	300	80	2,1	535	1321	2400	3000	NNU4944 KMW33
	340	90	3	890	1591	2200	2800	NN3044 MW33
	340	90	3	890	1591	2200	2800	NN3044 KMW33
240	320	80	2,1	556	1300	2200	2800	NNU4948 MW33
	320	80	2,1	556	1300	2200	2800	NNU4948 KMW33
	360	92	3	850	1560	2000	2600	NN3048 MW33
	360	92	3	850	1560	2000	2600	NN3048 KMW33



## Double Row Cylindrical Roller Bearings

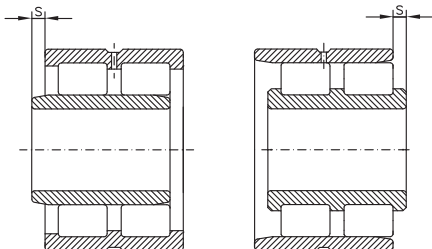

Abutment and fillet dimensions  
see on page 269-270

Bearing dimensions					Mass
d	E	F	B <sub>s</sub>	s	
mm					[kg]
160	-	178,5	6,5	2,3	6,67
	-	178,5	6,5	2,3	6,37
	219	-	9,5	4,2	9,42
	219	-	9,5	4,2	9,12
170	-	188,5	6,5	2,3	7,16
	-	188,5	6,5	2,3	6,85
	236	-	9,5	4,5	12,8
	236	-	9,5	4,5	12,4
180	-	202	9,5	2,6	10,6
	-	202	9,5	2,6	10,1
	255	-	12,2	4,8	16,9
	255	-	12,2	4,8	16,3
190	-	212	9,5	2,6	10,6
	-	212	9,5	2,6	10,1
	265	-	12,2	4,8	17,6
	265	-	12,2	4,8	17,1
200	-	225	12,2	3,4	16,5
	-	225	12,2	3,4	15,9
	282	-	12,2	5,3	23,1
	282	-	12,2	5,3	22,4
220	-	245	12,2	3,4	16,8
	-	245	12,2	3,4	16,1
	310	-	15	4,5	29,2
	310	-	15	4,5	28,2
240	-	265	12	3,4	18,0
	-	265	12	3,4	17,2
	330	-	15	6	31,9
	330	-	15	6	30,8



### Double Row Cylindrical Roller Bearings

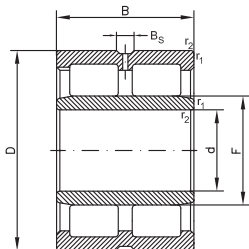

NNU49..W33

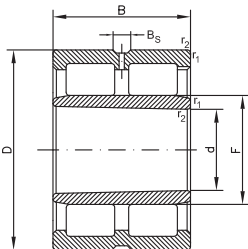

NNU49..K..W33

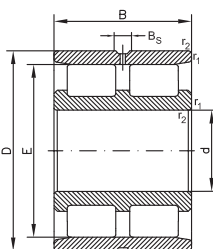

NN30..W33

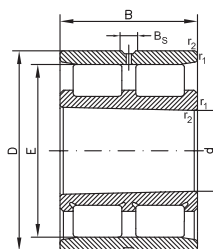

NN30..K..W33

d	Dimensions			Basical radial load		Speed limit		Designation
	D	B	r <sub>1</sub> , r <sub>2</sub> min.	dyn. C <sub>r</sub>	stat. C <sub>0r</sub>	grease	oil	
mm				kN		min <sup>-1</sup>		
260	360	100	2,1	750	1700	2000	2600	NNU4952 MW33
	360	100	2,1	750	1700	2000	2600	NNU4952 KMW33
	400	104	4	1060	2000	1900	2400	NN3052 MW33
	400	104	4	1060	2000	1900	2400	NN3052 KMW33
280	380	100	2,1	765	1800	1900	2400	NNU4956 MW33
	380	100	2,1	765	1800	1900	2400	NNU4956 KMW33
	420	106	4	1080	2080	1800	2200	NN3056 MW33
	420	106	4	1080	2080	1800	2200	NN3056 KMW33
300	420	118	3	1188	2943	1700	2000	NNU4960 MW33
	420	118	3	1188	2943	1700	2000	NNU4960 KMW33
	460	118	4	1270	2400	1600	1900	NN3060 MW33
	460	118	4	1270	2400	1600	1900	NN3060 KMW33
320	440	118	3	1060	2550	1600	1900	NNU4964 MW33
	480	121	4	1320	2600	1600	1900	NN3064 MW33
380	520	140	4	1705	4620	1100	1300	NNU4976 MW33
	520	140	4	1705	4620	1100	1300	NNU4976 KMW33
420	560	140	4	1786	5067	1000	1200	NNU4984 MW33
	560	140	4	1786	5067	1000	1200	NNU4984 KMW33

## Double Row Cylindrical Roller Bearings

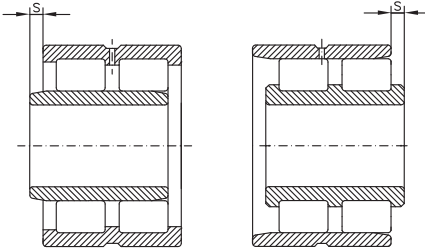

Abutment and fillet dimensions  
see on page 269-270

Bearing dimensions					Mass
d	E	F	B <sub>s</sub>	s	
mm					[kg]
260	-	292	15	4	31,3
	-	292	15	4	29,9
	364	-	15	6,5	47,4
	364	-	15	6,5	45,9
280	-	312	15	4	32,7
	-	312	15	4	31,2
	384	-	15	6,75	51,2
	384	-	15	6,75	49,5
300	-	339	17,7	5	52,3
	-	339	17,7	5	50,1
	418	-	17,7	7,45	71,2
	418	-	17,7	7,45	69,1
320	-	359	17,7	5	52,6
	438	-	17,7	7,95	76,8
380	-	426	19,7	5,5	91,9
	-	426	19,7	5,5	88,1
420	-	466	19,7	5,5	96,3
	-	466	19,7	5,5	92,1



### Cylindrical Roller Bearings, double row Non-standardized

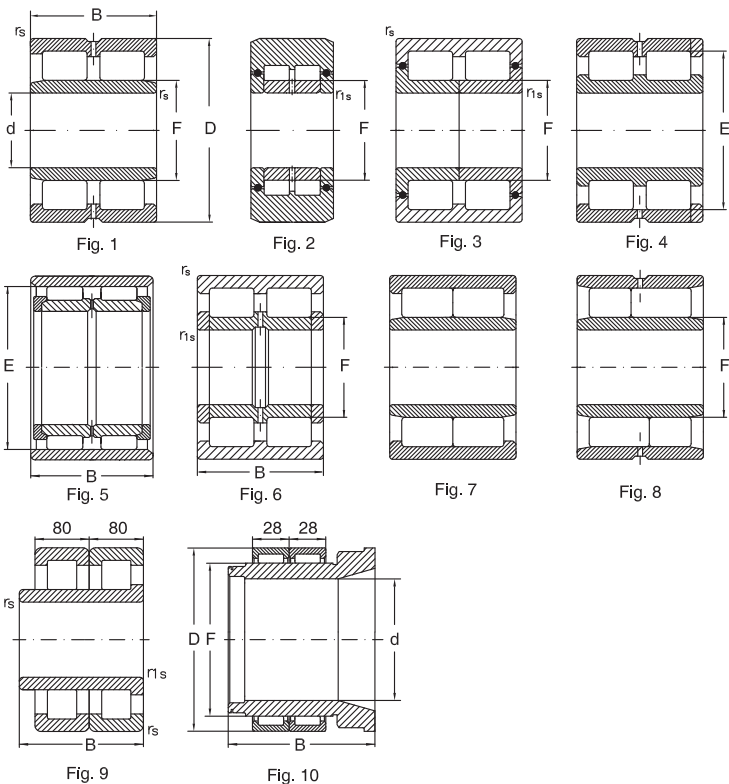

Dimensions						Fig.	Basical radial load		Speed limit		Mass	Designation
d	D	B	$r_{s \min}$	$r_{1s \min}$	E, F		dyn. $C_r$	stat. $C_{0r}$	grease	oil		
mm							kN		$\text{min}^{-1}$			
30	62	24	1	0,6	38	7	47,5	48,8	2400	3000	0,364	2NNU5106 M
52	110	125	1,5	1	72	10	218	303	1900	2300	3,99	480911
120	190	80	1,1		137	1	417	701	2400	3000	8,3	NNU5124 M
130	180	50	1,5	1,5	165,4	4	252	526	900	1300	3,9	NNP4926 VW33
	250	194	3	9	158	9	1028	1660	800	1000	39,04	484126
	300,02	150	4	2	151,3	6	1148	1810	800	1000	59,97	488926 MA
135	220	150		1	194	5	650	1363	2700	3400	23,014	LII-68853
150	300	120		4	182	2	984	1645	800	1000	45,285	NNUP5130 VC3W44
	300	120	6	4	184	3	817	1460	800	1000	47,55	493230 VC4
169,5	280	105	4		197	1	800	2000	1700	2000	27,3	NNU5134 MC5NA
178	272	94	2		203	1	883	1700	1700	2000	19,98	4877/178 M
330	533,4	254	6		393	8	3130	7755	560	800	246,7	489066 MC3NA

## Cylindrical roller bearings, multi rows

### Non-standardized

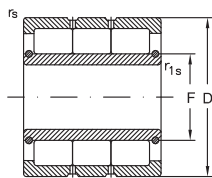

Fig. 1

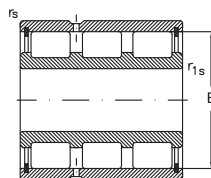

Fig. 2

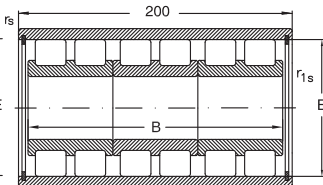

Fig. 3

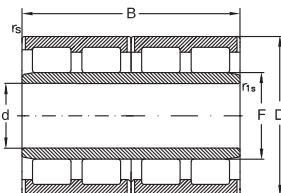

Fig. 4

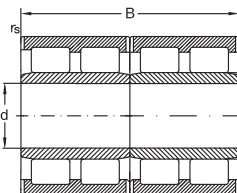

Fig. 5

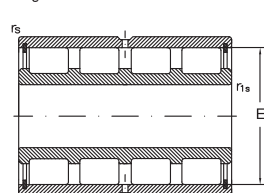

Fig. 6

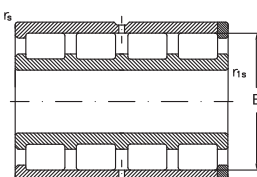

Fig. 7

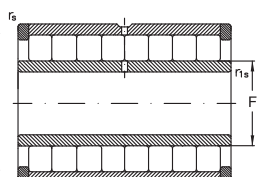

Fig. 8

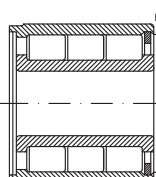

Fig. 9

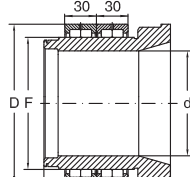

Fig. 10

Dimensions						Fig.	Basical radial load		Speed limit		Mass	Designation
d	D	B	r <sub>s</sub> min.	r <sub>1s</sub> min.	E, F		dyn. C <sub>r</sub>	stat. C <sub>0r</sub>	grease	oil		
mm							kN		min <sup>-1</sup>			
<b>65,019</b>	110	140	1,5	1	86,9	10	218	474	5700	7200	4,1	<b>CR0113.13 V</b>
<b>80</b>	125	80	1,1	1,1	94,5	8	355	833	1700	2100	4,1	<b>NNU6016 VC3</b>
<b>90</b>	125	68	1,5	1,5	115	6	258	602	1500	1900	2,7	<b>4NN5118 VW33</b>
<b>130</b>	182	81,5	2	2	170,4	9	495	1083	1200	1500	6,1	<b>3NN5226 VP5</b>
<b>140</b>	215	100	3	3	160,1	1	751	1576	2200	2600	13,7	<b>3NNU5128 V</b>
<b>145</b>	210	155	2	2	166	4	790	1930	2400	3000	17,8	<b>4NNU5129 PMC4W8</b>
<b>160</b>	230	168	1,5	1,5	179	4	896	2202	2400	3000	23,6	<b>4NNU5232 PMW8</b>
	230	168	1,5	1,5	182	4	850	2215	2400	3000	23,9	<b>4NNU5232 PMC4F182W8</b>
<b>170</b>	230	180	1,5	2	215	3	995	2832	750	900	22	<b>3NN5234 VC3</b>
<b>180</b>	260	168	2,1	2,1	202	4	1105	2563	1700	2000	29,8	<b>4NNU5136 PMC4W8</b>
<b>190</b>	260	101	2	2	240,5	2	771	1924	750	900	16,2	<b>3NN5138 VC3W33</b>
	270	200	2,1	2,1	212	4	1330	3296	1600	2000	36,3	<b>4NNU5138 PMW8</b>
<b>200</b>	280	152	2,1	2,1	259,2	6	1130	2955	700	850	32,5	<b>4NNU5232 VC3W33</b>
	280	152	2,1	2,1	259,2	7	1130	2955	700	850	32,5	<b>4NNP5240 VC3W33</b>
	290	192	2,1	2,1	226	4	1403	3387	1500	1800	44	<b>4NNU5140 PMC3W8</b>
<b>230</b>	330	206	2,1	2,1	260	4	1625	4014	1300	1600	63	<b>4NNU5146 PMC4W8</b>
<b>240</b>	360	218	3	1	272	5	1990	4763	1400	1800	83,1	<b>4NNU6040 EPDMW8</b>
<b>260</b>	370	220	3	3	292	4	2018	5241	1200	1400	77,8	<b>4NNU5152 PMC4W8</b>
	370	220	3	3	292	4	2018	5241	1200	1400	77,8	<b>4NNU5152 PMC4NAW8</b>
<b>280</b>	390	220	3	3	312	4	2058	5470	1100	1300	82,8	<b>4NNU5156 PMC3W8</b>
<b>300</b>	460	290	4	1,5	341	5	3519	8469	1100	1300	188	<b>NNU6060 EPDMW8</b>
<b>320</b>	840	290	4	1,5	360,8	5	3596	8858	950	1100	197	<b>NNU6064 EPDMW8</b>



### Set cylindrical roller bearings, double row Non-standardized

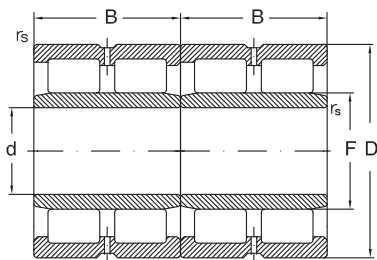

Fig. 1

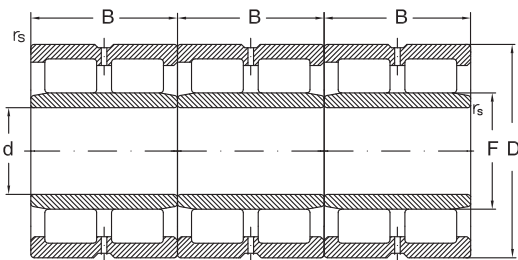

Fig. 2

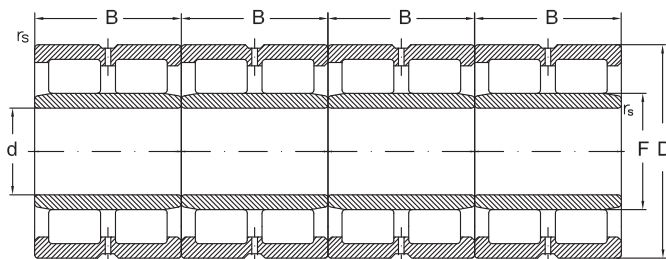

Fig. 3

Dimensions						Fig.	Basic radial load		Speed limit		Mass	Designation
d	D	B	$r_s$ min.	$r_{1s}$ min	F		dyn. $C_r$	stat. $C_{br}$	grease	oil		
mm							kN		min <sup>-1</sup>			
<b>260</b>	360	100	2,1	2,1	292	2	1828	5535	1600	1900	93,9	<b>3xNNU4952 MP53NAW33</b>
<b>300</b>	420	118	3	3	339	1	2036	5886	1300	1600	104,6	<b>2xNNU4960 MC3NAW33</b>
	420	118	3	3	339	2	2772	8829	1300	1600	156,9	<b>3xNNU4960 MC3NAW33</b>
<b>320</b>	440	118	3	3	359	1	2115	6220	1300	1500	110,1	<b>2xNNU4964 MC3NAW33</b>
<b>380</b>	520	140	4	4	426	2	4007	13860	1100	1300	275,7	<b>3xNNU4976 MC3NAW33</b>
<b>420</b>	560	140	4	4	466	3	5156	20264	1000	1200	402,4	<b>4xNNU4984 MC3NAW33</b>

## Cylindrical roller bearings without inner or outer ring

Non-standardized

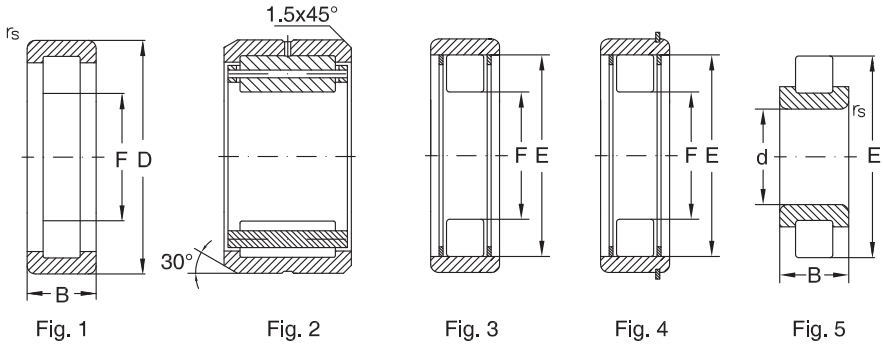

Fig. 1

Fig. 2

Fig. 3

Fig. 4

Fig. 5

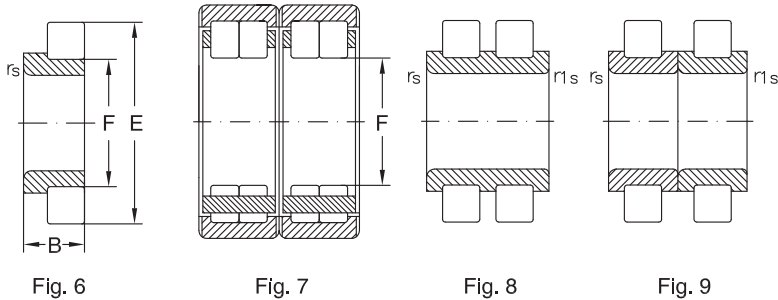

Fig. 6

Fig. 7

Fig. 8

Fig. 9

Dimensions						Fig.	Basical radial load		Speed limit		Mass	Designation
d	D	B	$r_s$ min.	$r_{1s}$ min	E, F		dyn. $C_r$	stat. $C_{0r}$	grease	oil		
mm							kN		min <sup>-1</sup>			
22	52	15	0,7		25	3	28,6	23,9	7000	14000	0,212	<b>RNU2R304 F2</b>
		22,5	1	0,3	38,75	8	34	35	3000	6000	0,107	<b>RNN5204 V</b>
30		26	0,6		60	5	77,4	84,1	5000	10000	0,361	<b>RN5506 M</b>
		62	20	1	37,2	1	61	66,3	5000	10000	0,222	<b>RNU2206 VH</b>
40		35,5	3	0,5	61,74	8	101	136	1700	3400	0,334	<b>RNN5408 V</b>
		39,5	3	0,5	61,74	8	112	164	1700	3400	0,354	<b>RNN40x61,74x39,5 V</b>
		78	14	3	40,025	1	29	31	1700	3400	0,333	<b>496208</b>
		80	30,16	1,1	49,93	1	88	107	1700	3400	0,573	<b>RNU5208 M6</b>
50		40	2,5	1	75,25	8	134	204	2900	3600	0,62	<b>RNN5110 V</b>
		90	23	1,5	45,02	4	68,6	59,7	2900	3600	0,585	<b>490907</b>
		95	34		68	2	144,3	205	2900	3600	0,831	<b>35914</b>
		100	21	1	66,92	1	70,4	82,6	3500	7000	0,554	<b>RNU5311</b>
		100	33,33	1,5	66,95	1	99,2	129	3500	7000	0,912	<b>RNU5411 M</b>
60		100	33,33	1	66,95	3	99,2	129	3500	7000	0,818	<b>RNU2R5411</b>
		26	1,1		86,74	5	108	150	2400	4800	0,42	<b>RN3012 V</b>
		28,53	2	0,3	127	6	177	182	2400	4800	1,86	<b>RNPJ5112 M</b>
		102	61	1,5	60	1	234	356	2300	2900	2,19	<b>RNU5212 V</b>



### Cylindrical roller bearings without inner or outer ring Non-standardized

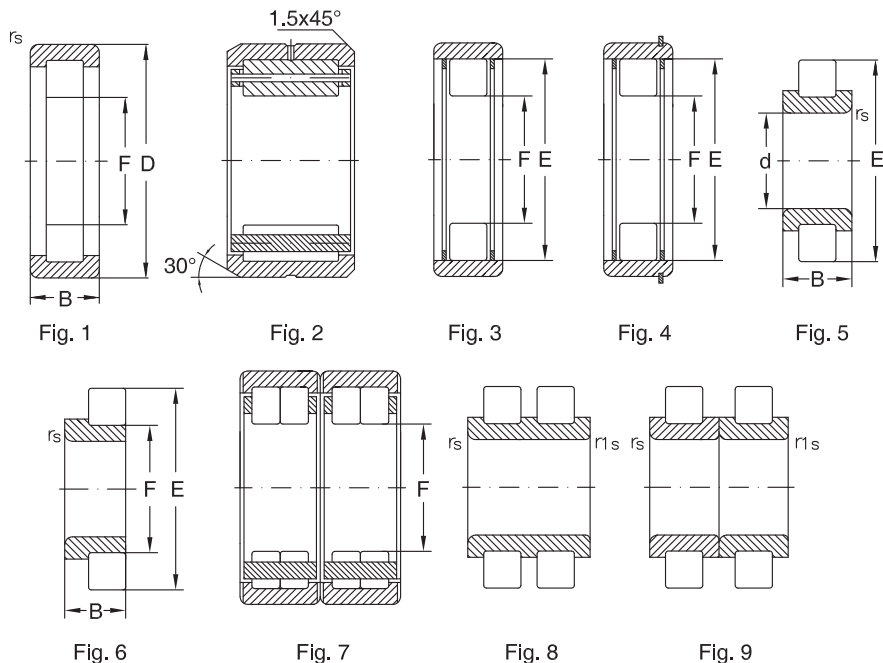

Dimensions						Fig.	Basical radial load		Speed limit		Mass	Designation
d	D	B	r <sub>s</sub> min.	r <sub>1s</sub> min	E, F		dyn. C <sub>r</sub>	stat. C <sub>0r</sub>	grease	oil		
mm							kN		min <sup>-1</sup>			
60	120	38,1	1		80,48	3	140	187	2600	5300	1,32	RNU2R5513
	120	38,1	1		80,48	1	140	187	2600	5300	1,53	RNU513 MA
	140	44,45	2		95,36	1	136	259	2400	4500	2,25	RNU5116 M
	170	55,56	2		113,6	1	327	453	1900	3800	4,51	RNU5119 M
	215	76,2	2		145,23	1	569	878	1500	3000	9,66	RNU5124 M
	225	156	2		169	7	1031	2255	1500	3000	17,18	RNNU6029 PMW8
75		62	3,5	1,5	115,78	9	312	481	1000	2200	2,146	489715 V
90		72	5	1,5	130,11	8	341	562	1000	2200	2,78	RNN90x130,11x72 VW26
95		55,56	3,3		151,252	5	330	475	1000	2200	3,749	470519 M
130		110	4		269,55	5	1400	1900	750	1600	27,452	000012-70330
710		74	4		825,6	5	1966	5303	120	260	60,213	1110376



# URB





# Tapered roller bearings

Tapered roller bearings have the rolling elements under the form of a frustum of a cone.

They roll on tapered surfaces which, if it's extended, converge towards a single point on the bearing axis.

The rollers are guided tangentially by the cage and axially by the big rib of the outer ring, on which they have point contact. As between roller and raceways there is linear contact, tapered roller bearings can take heavy radial loads. They can also take heavy axial or combined loads, depending on the contact angle caused by the tapered rolling elements. The

contact angle is the angle of the outer raceway generatrix.

Constructive versions for single row tapered roller bearings:

- single row

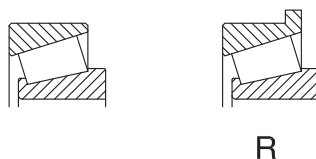

## Suffixes

- A** - increased basic load
- B** - enlarged contact angle
- F** - machined cage of hardened steel or special cast iron
- F2** - constructive modifications
- J** - pressed cage of not hardened steel sheet
- K** - tapered bore 1:12
- M** - machined brass cage

**P6X** - tolerance class with smaller values than normal

**P5** - tolerance class with smaller values than P6X

**P4** - tolerance class with smaller values than P5

**P2** - tolerance class with smaller values than P4

**R** - rib on the outer ring

**S0** - operating temperature up to +150°C

**S1** - operating temperature up to +200°C

**TN** - polyamide cage

**X** - modified main dimensions according to ISO

## Single row tapered roller bearings

Single row tapered roller bearings are of separable design, i.e. the outer ring and the inner ring with rollers and cage assembly can be separately mounted. These two assemblies are interchangeable.

Tapered roller bearings can be manufactured both in standardized constructive versions with dimensions series 320, 302, 322, 303, 323, 313 and with non-standardized dimensions, mm or inch.

Tapered roller bearings can carry only single direction axial loads. Under pure radial loads, an axial force occurs which is supposed to distance the bearing ring in axial direction.

Therefore, tapered roller bearings are generally pair mounted on both ends of the shaft, in "X" or "O"

arrangements, so that the shaft will be axially located in both directions (table 3). Thus, the optimum clearance in these two bearings can be adjusted.

Single row tapered roller bearings can also be manufactured with rib on the outer ring. This design is to be used when the housing cannot be manufactured with shoulder, but only with a passed through bore. In this case, axial location can be provided by the bearing ring.

Permissible values of misalignment between shaft and housing are given in table 1, depending on bearing size and load magnitude.

## Tolerances

Tapered roller bearings are generally manufactured



Permissible misalignment <span style="float: right;">Table 1</span>		
Bearings series	Load magnitude	Permissible misalignment
329, 320, 330, 331, 302, 322, 332, 313, 303	$F/C_{or} < 0,1$ $F_r/C_{or} > 0,1$	2' 4'
323	$F/C_{or} < 0,1$ $F_r/C_{or} > 0,1$	1'30" 3'

to the normal tolerance class ISO and AFBMA, respectively (for bearings with inch dimensions).

For certain applications (e.g. bearings for machine-tools), they can be also manufactured to tolerance classes P5 and P6X or 3 AFBMA.

At request, they can be manufactured to tolerance class P4.

Single row tapered roller bearings have the outer rings interchangeable with the inner ring - rollers - cage assembly (if they have the same mark) and also with bearings produced by other companies, according to ISO and AFBMA respectively.

The tolerances for bearings overall dimensions are given in tables on the pages 34-38 for tapered roller bearings, both with metric and inch dimensions. Tolerances for mounting chamfer are given in tables on page 42.

### Cages

Small and medium-sized tapered roller bearings are generally fitted with pressed sheet cages. Large

sized bearings are generally fitted with machined steel or brass cages, with welded pins. In some cases, median or large sized bearings can also be fitted with machined steel or brass cages. In all cases, the cage is guided on rollers.

For small and medium sized bearings, glass fibre reinforced polyamide 6.6 cages can be successfully used if the operating temperature doesn't exceed +120°C. They have low mass, are noiseless in operation and have low coefficient of friction.

Design and some technical data are given in table 2.

### Equivalent dynamic radial load

Equivalent dynamic radial load can be calculated using the following equations:

$$P_r = F_r, \text{ kN}, \quad \text{when } F_a/F_r \leq e$$

$$P_r = 0,4 F_r + YF_a, \text{ kN}, \quad \text{when } F_a/F_r > e$$

Fa values can be calculated using the equations in table 3.

These equations are available when bearings are mounted so that axial clearance is in fact zero without preloading.  $F_{rA}$  and  $F_{rB}$  should always be considered as being positive, even if they act in the opposite direction to that in the figure.

The values of e, Y are given in bearing tables.

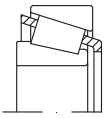
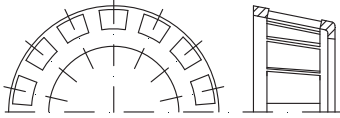
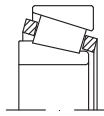
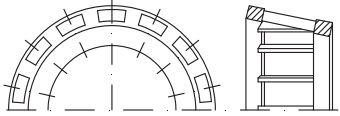
Cage design and some technical data <span style="float: right;">Table 2</span>					
Cage	Design		Application	Max. value $D_m$	
	bearing	cage		oil	grease
	Pressed sheet cage				- General application - Small and medium sized bearings $d \leq 250$ mm
Machined brass cage M			- General application - Median and large sized bearings $d > 150$ mm	450x10 <sup>3</sup>	315x10 <sup>3</sup>

## Equivalent static radial load

Equivalent static radial load can be calculated using the equations:

$$P_{0r} = F_r, \text{ kN,} \quad \text{when } F_a/F_r \leq 1/2 Y_0$$

$$P_{0r} = 0,5 F_r + Y_0 F_a, \text{ kN,} \quad \text{when } F_a/F_r > 1/2 Y_0$$

$F_a$  is calculated as in case of equivalent dynamic

radial load. The values of  $Y_0$  are given in bearing tables.

## Abutment dimensions

The mounting dimensions of tapered roller bearings are given in the bearings tables, for single row tapered roller bearings. These dimensions are also available for bearings with ribs.

Calculating relations for axial loadings $F_a$		Table 3
		Table 3
		Table 3
	<p>1a) <math>\frac{F_{rA}}{Y_A} \geq \frac{F_{rB}}{Y_B}</math></p> <p><math>K_a \geq 0</math></p>	<p><math>F_{aA} = \frac{0,5F_{rA}}{Y_A}</math></p> <p><math>F_{aB} = F_{aA} + K_a</math></p>
	<p>1b) <math>\frac{F_{rA}}{Y_A} &lt; \frac{F_{rB}}{Y_B}</math></p> <p><math>K_a \geq 0,5 \left( \frac{F_{rB}}{Y_B} - \frac{F_{rA}}{Y_A} \right)</math></p>	<p><math>F_{aA} = \frac{0,5F_{rA}}{Y_A}</math></p> <p><math>F_{aB} = F_{aA} + K_a</math></p>
	<p>1c) <math>\frac{F_{rA}}{Y_A} &lt; \frac{F_{rB}}{Y_B}</math></p> <p><math>K_a &lt; 0,5 \left( \frac{F_{rB}}{Y_B} - \frac{F_{rA}}{Y_A} \right)</math></p>	<p><math>F_{aA} = F_{aB} - K_a</math></p> <p><math>F_{aB} = \frac{0,5F_{rB}}{Y_B}</math></p>
	<p>2a) <math>\frac{F_{rA}}{Y_A} \leq \frac{F_{rB}}{Y_B}</math></p> <p><math>K_a \geq 0</math></p>	<p><math>F_{aA} = F_{aB} + K_a</math></p> <p><math>F_{aB} = \frac{0,5F_{rB}}{Y_B}</math></p>
	<p>2b) <math>\frac{F_{rA}}{Y_A} &gt; \frac{F_{rB}}{Y_B}</math></p> <p><math>K_a \geq 0,5 \left( \frac{F_{rA}}{Y_A} - \frac{F_{rB}}{Y_B} \right)</math></p>	<p><math>F_{aA} = F_{aB} + K_a</math></p> <p><math>F_{aB} = \frac{0,5F_{rB}}{Y_B}</math></p>
	<p>2c) <math>\frac{F_{rA}}{Y_A} &gt; \frac{F_{rB}}{Y_B}</math></p> <p><math>K_a &lt; 0,5 \left( \frac{F_{rA}}{Y_A} - \frac{F_{rB}}{Y_B} \right)</math></p>	<p><math>F_{aA} = \frac{0,5F_{rA}}{Y_A}</math></p> <p><math>F_{aB} = F_{aA} - K_a</math></p>



Tapered roller bearings, single row

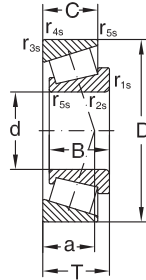

Dimensions									Designation	ISO series	Basic radial load. Factors				
d	D	B	C	T	r <sub>1s,2s</sub> min.	r <sub>3s,4s</sub> min.	r <sub>5</sub> min.	a			dyn. C <sub>r</sub>	e	Y	stat C <sub>0r</sub>	Y <sub>0</sub>
mm											kN	-	-	kN	-
15	35	11	10	11,75	0,6	0,6	0,3	8,2	<b>30202 A</b>	-	14,8	0,32	1,9	13,2	1
	42	13	11	14,25	1	1	0,3	9	<b>30302 A</b>	2FB	21,5	0,28	2,1	19,8	1,1
17	40	12	11	13,25	1	1	0,3	10	<b>30203 A</b>	2DB	18,3	0,35	1,7	19	0,9
	40	16	14	17,25	1	1	0,3	11,2	<b>32203 A</b>	2DD	27	0,31	1,9	28	1,1
	47	14	12	15,25	1	1	0,3	10	<b>30303 A</b>	2FB	26	0,28	2,1	24,5	1,1
	47	19	16	20,25	1	1	0,3	12	<b>32303 A</b>	2FD	34	0,28	2,1	35,5	1,1
20	42	15	12	15	0,6	0,6	0,3	10	<b>32004 XA</b>	3CC	26	0,37	1,6	28,5	0,9
	47	14	12	15,25	1	1	0,3	11	<b>30204 A</b>	2DB	25,8	0,35	1,7	26,4	0,9
	47	18	15	19,25	1	1	0,3	12,5	<b>32204 A</b>	2DD	30	0,33	1,8	35	1
	52	15	13	16,25	1,5	1,5	0,6	11	<b>30304 A</b>	2FB	32	0,3	2	32	1,1
25	52	21	18	22,25	1,5	1,5	0,6	14	<b>32304 A</b>	2FD	42,5	0,3	2	47	1,1
	47	15	11,5	15	0,6	0,6	0,3	11	<b>32005 XA</b>	4CC	26	0,43	1,4	33,5	0,8
	47	17	14	17	0,6	0,6	0,3	11	<b>33005</b>	2CE	31	0,29	2,1	38	1,1
	52	15	13	16,25	1	1	0,3	12	<b>30205 A</b>	3CC	30,1	0,37	1,6	32,9	0,9
	52	18	15	19,25	1	1	0,3	16	<b>32205 A</b>	2CD	31	0,33	1,8	37	1
	52	22	18	22	1	1	0,3	14	<b>33205</b>	2DE	48,5	0,35	1,71	58	0,94
	62	17	15	18,25	1,5	1,5	0,6	13	<b>30305 A</b>	2FB	43	0,3	2	43	1,1
	62	17	13	18,25	1,5	1,5	0,6	20	<b>31305 A</b>	7FB	39	0,83	0,7	41	0,4
30	62	24	20	25,25	1,5	1,5	0,6	15	<b>32305 A</b>	2FD	58,3	0,3	2	60,3	1,1
	55	17	13	17	1	1	0,3	13	<b>32006 XA</b>	4CC	34	0,43	1,4	45,5	0,8
	55	20	16	20	1	1	0,3	13,1	<b>33006</b>	2CE	42	0,29	2,1	54	1,1
	62	16	14	17,25	1	1	0,3	14	<b>30206 A</b>	3DB	40,5	0,37	1,6	45,1	0,9
	62	20	17	21,25	1	1	0,3	15	<b>32206 A</b>	3DC	49	0,37	1,6	61	0,9
	62	25	19,5	25	1	1	0,3	16	<b>33206</b>	2DE	65	0,34	1,76	77	0,97
	72	19	16	20,75	1,5	1,5	0,6	15	<b>30306 A</b>	2FB	52,9	0,37	1,9	51,8	1,1
	72	19	14	20,75	1,5	1,5	0,6	22	<b>31306 A</b>	7FB	46,5	0,31	0,7	49,5	0,4
35	72	27	23	28,75	1,5	1,5	0,6	18	<b>32306 A</b>	2FD	75,8	0,83	1,9	82,7	1,1
	62	18	14	18	1	1	0,3	15	<b>32007 XA</b>	4CC	35,9	0,31	1,3	52,4	0,7
	62	21	17	21	1	1	0,3	14,1	<b>33007</b>	2CE	49	0,31	2	65	1,1
	72	17	15	18,25	1,5	1,5	0,6	15	<b>30207 A</b>	3DB	50,5	0,46	1,6	54,7	0,9
	72	23	19	24,25	1,5	1,5	0,6	17	<b>32207 A</b>	3DC	66,2	0,37	1,6	77,5	0,9
	72	28	22	28	1,5	1,5	0,6	18	<b>33207</b>	2DE	86	0,35	1,7	105	0,93
	80	21	18	22,75	2	1,5	0,6	16	<b>30307 A</b>	2FB	71,2	0,37	1,9	72,5	1,1
	80	21	15	22,75	2	1,5	0,6	25	<b>31307 A</b>	7FB	58,1	0,31	0,7	64	0,4
40	80	31	25	32,75	2	1,5	0,6	20	<b>32307 A</b>	2FE	95,3	0,83	1,9	106	1,1
	68	19	14,5	19	1	1	0,3	15	<b>32008 XA</b>	3CD	48,8	0,31	1,6	65,6	0,9
	68	22	18	22	1	1	0,3	14,6	<b>33008</b>	2BE	59	0,28	2,1	81,5	1,2
	75	26	20,5	26	1,5	1,5	0,3	18	<b>33108</b>	2CE	79	0,36	1,69	103	0,93
	80	18	16	19,75	1,5	1,5	0,6	16	<b>30208 A</b>	3DB	57,9	0,37	1,6	62,4	0,9
	80	23	19	24,75	1,5	1,5	0,6	19	<b>32208 A</b>	3DC	66,2	0,37	1,6	79,5	0,9

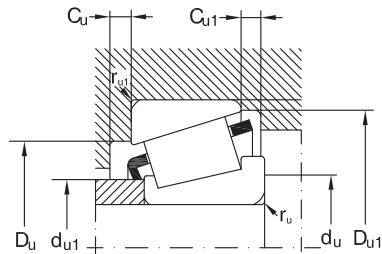

Speed limit		Mass	Mounting dimensions								
grease	oil		d <sub>u1</sub> max.	d <sub>u</sub> min.	D <sub>u</sub>		D <sub>u1</sub> min.	C <sub>u</sub> min.	C <sub>u1</sub> min.	r <sub>u</sub> max.	r <sub>u1</sub> max.
					min.	max.					
min <sup>-1</sup>		Kg									
11000	15000	0,05	19	23	30	30	33	2	1,5	0,6	0,6
9000	13000	0,09	22	21	36	36	38	2	3	1	1
9000	13000	0,074	23	23	34	34	37	2	2	1	1
9000	13000	0,11	22	26	34	34	37	2	3	1	1
8500	12000	0,13	25	23	40	41	42	2	3	1	1
8000	11000	0,17	24	23	39	41	43	3	4	1	1
8500	12000	0,097	25	25	36	37	39	3	3	0,6	0,6
8000	11000	0,12	27	26	40	41	43	2	3	1	1
8500	11000	0,16	25	29	38	41	44,5	3	4	1	1
8000	11000	0,17	28	27	44	45	47	2	3	1,5	1,5
7500	10000	0,221	27	27	43	45	47	3	4	1,5	1,5
8000	11000	0,113	30	30	40	42	44	3	3,5	0,6	0,6
8000	11000	0,13	29	33	41	42	44	3	3	0,6	0,6
7500	10000	0,15	31	31	44	46	48	2	3	1	1
7500	10000	0,182	31	31	44	46	48	3	4	1	1
7500	10000	0,214	30	31	43	46	49	4	4	1	1
6700	9000	0,25	34	32	54	55	57	2	3	1,5	1,5
5600	7500	0,255	34	32	47	55	59	3	5	1,5	1,5
6000	8000	0,36	33	32	53	55	57	3	5	1,5	1,5
6700	9000	0,017	35	36	48	49	52	3	4	1	1
6700	9000	0,21	35	39	48	49	52	3	4	1	1
6300	8500	0,22	35	36	53	56	57	2	3	1	1
6300	8500	0,28	37	36	52	56	59	3	4	1	1
6300	8500	0,39	36	36	53	56	59	5	5,5	1	1
5600	7500	0,38	37	37	62	65	66	3	4,5	1,5	1,5
5000	6700	0,39	40	37	55	65	68	3	6,5	1,5	1,5
5300	7000	0,55	40	37	59	65	66	4	5,5	1,5	1,5
6000	8000	0,22	39	41	54	56	59	4	4	1	1
6000	8000	0,27	40	44	55	56	59	4	4	1	1
5300	7000	0,32	40	42	62	65	67	3	3	1,5	1,5
5300	7000	0,42	44	42	61	65	67	3	5,5	1,5	1,5
5300	7000	0,58	42	42	61	65	68	5	6	1,5	1,5
5000	6700	0,52	43	44	70	71	74	3	4,5	2	1,5
4500	6000	0,52	45	44	62	71	76	4	7,5	2	1,5
4800	6300	0,73	44	44	66	71	74	4	7,5	2	1,5
5300	7000	0,27	44	46	60	62	65	4	4,5	1	1
5300	7000	0,32	45	49	61	62	65	4	4	1	1
5300	7000	0,54	47	47	65	68	71	4	5,5	1,5	1,5
4800	6300	0,42	46	47	69	73	74	3	3,5	1,5	1,5
4800	6300	0,51	49	47	68	73	75	3	5,5	1,5	1,5



Tapered roller bearings, single row

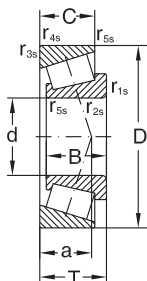

Dimensions									Designation	ISO series	Basic radial load. Factors				
d	D	B	C	T	r <sub>1s,2s</sub> min.	r <sub>3s,4s</sub> min.	r <sub>5</sub> min.	a			dyn. C <sub>r</sub>	e	Y	stat C <sub>0r</sub>	Y <sub>0</sub>
mm											kN	-	-	kN	-
40	80	32	25	32	1,5	1,5	0,6	21	<b>33208</b>	2DE	105	0,36	1,68	134	0,92
	90	23	20	25,25	2	1,5	0,6	19	<b>30308 A</b>	2FB	83,9	0,37	1,7	91,3	0,9
	90	23	17	25,25	2	1,5	0,6	28	<b>31308 A</b>	7FB	74,6	0,83	0,7	60,8	0,4
	90	33	27	35,25	2	1,5	0,6	23	<b>32308 A</b>	2FD	105	0,35	1,7	122	0,9
45	75	20	15,5	20	1	1	0,3	16	<b>32009 XA</b>	3CC	57	0,4	1,5	82,2	0,8
	75	24	19	24	1	1	0,3	16,3	<b>33009</b>	2CE	69	0,29	2	99	1,1
	80	26	20,5	26	1,5	1,5	0,3	19	<b>33109</b>	3CE	84	0,38	1,57	115	0,86
	85	19	16	20,75	1,5	1,5	0,6	18	<b>30209 A</b>	3DB	60,1	0,4	1,5	67,1	0,8
	85	23	19	24,75	1,5	1,5	0,6	20	<b>32209 A</b>	3DC	76,5	0,4	1,5	91,6	0,8
	85	32	25	32	1,5	1,5	0,6	22	<b>33209</b>	3DE	107	0,39	1,56	146	0,86
	100	25	22	27,25	2	1,5	0,6	21	<b>30309 A</b>	2FB	106	0,35	1,7	118	0,9
	100	25	18	27,25	2	1,5	0,6	31	<b>31309 A</b>	7FB	88,9	0,83	0,7	97,1	0,4
	100	36	30	38,25	2	1,5	0,6	25	<b>32309 A</b>	2FD	133	0,35	1,7	159	0,9
	50	80	20	15,5	20	1	1	0,3	18	<b>32010 XA</b>	3CC	58,5	0,43	1,4	88,5
80		24	19	24	1	1	0,3	17	<b>33010</b>	2CE	75	0,32	1,9	113	1,04
85		26	20	26	1,5	1,5	0,3	20	<b>33110</b>	3CE	86	0,41	1,46	122	0,8
90		20	17	21,75	1,5	1,5	0,6	19	<b>30210 A</b>	3DB	69,7	0,43	1,4	81,3	0,8
90		23	19	24,75	1,5	1,5	0,6	21	<b>32210 A</b>	3DC	79,1	0,43	1,4	95,8	0,8
90		32	24,5	32	1,5	1,5		23	<b>33210</b>	3DE	115	0,41	1,45	163	0,8
110		27	23	29,25	2,5	2	0,6	23	<b>30310 A</b>	2FB	120	0,35	1,7	133	0,9
55	90	27	19	29,25	2,5	2	0,6	34	<b>31310 A</b>	7FB	102	0,83	0,7	112	0,4
	110	40	33	42,25	2,5	2	0,6	27	<b>32310 A</b>	2FD	160	0,35	1,7	194	0,9
	90	23	17,5	23	1,5	1,5	0,6	20	<b>32011 XA</b>	3CC	77	0,4	1,5	117	0,8
	90	27	21	27	1,5	1,5	0,6	19	<b>33011</b>	2CE	94	0,31	1,92	142	1,06
	95	30	23	30	1,5	1,5	0,6	22	<b>33111</b>	3CE	113	0,37	1,6	163	0,88
	100	21	18	22,75	2	1,5	0,6	20	<b>30211 A</b>	3DB	83	0,4	1,5	95,2	0,8
	100	25	21	26,75	2	1,5	0,6	22	<b>32211 A</b>	3DC	96,2	0,4	1,5	115	0,8
	100	35	27	35	2	1,5	0,6	26	<b>33211</b>	3DE	138	0,4	1,5	194	0,83
	120	29	25	31,5	2,5	2	0,6	24	<b>30311 A</b>	2FB	146	0,35	1,7	166	0,9
	120	29	21	31,5	2,5	2	0,6	37	<b>31311 A</b>	7FB	118	0,83	0,7	133	0,4
120	43	35	45,5	2,5	2	0,6	29	<b>32311 A</b>	2FD	191	0,35	1,7	235	0,9	
60	95	23	17,5	23	1,5	1,5	0,6	21	<b>32012 XA</b>	4CC	78,5	0,43	1,4	119	0,8
	95	27	21	27	1,5	1,5	0,6	20	<b>33012</b>	2CE	95	0,33	1,83	148	1,01
	100	30	23	30	1,5	1,5	0,6	23	<b>33112</b>	3CE	116	0,4	1,51	171	0,83
	110	22	19	23,75	2	1,5	0,6	22	<b>30212 A</b>	3EB	91,6	0,4	1,5	105	0,8
	110	28	24	29,75	2	1,5	0,6	24	<b>32212 A</b>	3EC	122	0,4	1,5	152	0,8
	110	38	29	38	2	1,5	0,6	28	<b>33212</b>	3EE	169	0,4	1,48	237	0,82
	130	31	26	33,5	3	2,5	1	26	<b>30312 A</b>	2FB	164	0,35	1,7	187	0,9
	130	31	22	33,5	3	2,5	1	39	<b>31312 A</b>	7FB	140	0,83	0,7	158	0,4
130	46	37	48,5	3	2,5	1	31	<b>32312 A</b>	2FD	229	0,35	1,7	288	0,9	



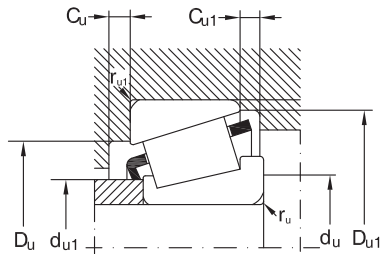

Speed limit		Mass	Mounting dimensions									
grease	oil		d <sub>u1</sub> max.	d <sub>u</sub> min.	D <sub>u</sub>		D <sub>u1</sub> min.	C <sub>u</sub> min.	C <sub>u1</sub> min.	r <sub>u</sub> max.	r <sub>u1</sub> max.	
					min.	max.						
min <sup>-1</sup>		Kg										
4800	6300	0,74	47	47	67	73	76	5	7	1,5	1,5	
4500	6000	0,7	48	49	77	81	82	3	5	2	1,5	
4000	5300	0,685	52	49	71	81	86	4	8	2	1,5	
4000	5300	0,993	51	49	73	81	82	4	8	2	1,5	
4800	6300	0,33	50	51	67	69	72	4	4,5	1	1	
4800	6300	0,41	51	54	67	69	71	4	5	1	1	
4800	6300	0,597	52	52	69	73	77	4	5,5	1,5	1,5	
4500	6000	0,47	51	52	74	78	80	3	4,5	1,5	1,5	
4500	6000	0,56	54	52	73	78	80	3	5,5	1,5	1,5	
4500	6000	0,89	52	52	72	78	81	5	7	1,5	1,5	
4000	5300	0,92	53	54	86	91	92	3	5	2	1,5	
3400	4500	0,915	59	54	79	91	95	4	9	2	1,5	
3600	4800	1,25	56	54	82	91	93	4	8	2	1,5	
4500	6000	0,36	56	56	72	74	77	4	4,5	1	1	
4500	6000	0,47	56	56	72	74	76	4	5	1	1	
4300	5600	0,6	56	57	74	78	82	4	6	1,5	1,5	
4300	5600	0,53	58	57	79	83	85	3	4,5	1,5	1,5	
4300	5600	0,6	58	57	78	83	85	3	5,5	1,5	1,5	
4300	5600	0,97	57	57	77	83	87	5	7,5	1,5	1,5	
3600	4800	1,19	65	60	95	100	102	4	6	2,5	2	
3200	4300	1,16	62	60	87	100	104	4	10	2,5	2	
3200	4300	1,83	62	60	90	100	102	5	9	2,5	2	
4000	5300	0,54	63	62	81	83	86	4	5,5	1,5	1,5	
4000	5300	0,67	63	62	81	83	86	5	6	1,5	1,5	
3800	5000	0,89	62	62	83	88	91	5	7	1,5	1,5	
3800	5000	0,69	64	64	88	91	94	4	4,5	1,5	1,5	
3800	5000	0,82	63	64	87	91	95	4	5,5	1,5	1,5	
3800	5000	1,17	62	64	85	91	96	6	8	2	1,5	
3200	4300	1,53	71	65	104	110	111	4	6,5	2	2	
2800	3800	1,49	68	65	94	110	113	4	10,5	2	2	
3000	4000	2,21	68	65	99	110	111	5	10,5	2	2	
3800	5000	0,58	67	67	85	88	91	4	5,5	1,5	1,5	
3800	5000	0,71	67	67	85	88	90	5	6	1,5	1,5	
3400	4500	1,01	67	67	88	93	96	5	7	1,5	1,5	
3400	4500	0,86	70	69	96	101	103	4	4,5	2	1,5	
3400	4500	1,1	69	69	95	101	104	4	5,5	2	1,5	
3400	4500	1,55	69	69	93	101	105	6	9	2	1,5	
3000	4000	1,9	77	72	112	118	120	5	7,5	3	2,5	
2600	3600	1,83	73	72	103	118	123	5	11,5	3	2,5	
2600	3600	2,8	74	72	107	118	120	6	11,5	3	2,5	



Tapered roller bearings, single row

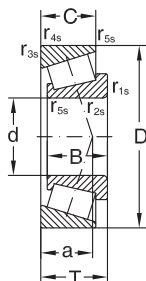

Dimensions									Designation	ISO series	Basic radial load. Factors				
d	D	B	C	T	r <sub>1s,2s</sub> min.	r <sub>3s,4s</sub> min.	r <sub>5</sub> min.	a			dyn. C <sub>r</sub>	e	γ	stat C <sub>0r</sub>	Y <sub>0</sub>
mm											kN	-	-	kN	-
65	100	23	17,5	23	1,5	1,5	0,6	22	<b>32013 XA</b>	4CC	80,6	0,46	1,3	123	0,7
	100	27	21	27	1,5	1,5	0,6	21	<b>33013</b>	2CE	100	0,35	1,72	161	0,95
	110	34	26,5	34	1,5	1,5	0,6	26	<b>30113</b>	3DE	149	0,39	1,55	225	0,85
	120	23	20	24,75	2	1,5	0,6	23	<b>30213 A</b>	3EB	111	0,4	1,5	129	0,8
	120	31	27	32,75	2	1,5	0,6	27	<b>32213 A</b>	3EC	149	0,4	1,5	189	0,8
	120	41	32	41	2	1,5	0,6	30	<b>33213</b>	3EE	203	0,39	1,54	285	0,85
	140	33	28	36	3	2,5	1	28	<b>30313 A</b>	2GB	191	0,35	1,7	220	0,9
	140	33	23	36	3	2,5	1	42	<b>31313 A</b>	7GB	164	0,83	0,7	189	0,4
70	140	48	39	51	3	2,5	1	33	<b>32313 A</b>	2GO	256	0,35	1,7	322	0,9
	110	25	19	25	1,5	1,5	0,6	23	<b>32014 XA</b>	4CC	95,6	0,43	1,4	143	0,8
	110	31	25,5	31	1,5	1,5	0,6	22	<b>33014</b>	2CE	136	0,28	2,11	223	1,16
	120	37	29	37	2	1,5	0,6	28	<b>33114</b>	3DE	174	0,38	1,58	260	0,87
	125	24	21	26,25	2	1,5	0,6	25	<b>30214 A</b>	3EB	119	0,43	1,4	143	0,8
	125	31	27	33,25	2	1,5	0,6	28	<b>32214 A</b>	3EC	157	0,43	1,4	204	0,8
	125	41	32	41	2	1,5	0,6	31	<b>33214</b>	3EE	210	0,41	1,47	300	0,81
	150	35	30	38	3	2,5	1	29	<b>30314 A</b>	2GB	224	0,35	1,7	264	0,9
75	150	35	25	38	3	2,5	1	45	<b>31314 A</b>	7GB	185	0,83	0,7	215	0,4
	150	51	42	54	3	2,5	1	36	<b>32314 A</b>	2GD	297	0,35	1,7	381	0,9
	115	25	19	25	1,5	1,5	0,6	25	<b>32015 XA</b>	4CC	97,3	0,46	1,3	149	0,7
	115	31	25,5	31	1,5	1,5	0,6	23	<b>33015</b>	2CE	139	0,3	2,01	232	1,11
	125	37	29	37	2	1,5	0,6	30	<b>33115</b>	3DE	178	0,4	1,51	275	0,83
	130	25	22	27,25	2	1,5	0,6	27	<b>30215 A</b>	4DB	134	0,43	1,4	166	0,8
	130	31	27	33,25	2	1,5	0,6	29	<b>32215 A</b>	4DC	157	0,43	1,4	205	0,8
	130	41	31	41	2	1,5	0,6	32	<b>33215</b>	3EE	206	0,43	1,4	310	0,77
80	160	37	31	40	3	2,5	1	31	<b>30315 A</b>	2GB	246	0,35	1,7	289	0,9
	160	37	26	40	3	2,5	1	48	<b>31315 A</b>	7GB	213	0,83	0,7	251	0,4
	160	55	45	58	3	2,5	1	38	<b>32315 A</b>	2GD	350	0,35	1,7	460	0,9
	125	29	22	29	1,5	1,5	0,6	27	<b>32016 XA</b>	3CC	130	0,43	1,4	198	0,8
	125	36	29,5	36	1,5	1,5	0,6	26	<b>33016</b>	2CE	175	0,28	2,16	290	1,19
	130	37	29	37	2	1,5	0,6	31	<b>33116</b>	3DE	188	0,42	1,44	300	0,79
	140	26	22	28,25	2,5	2	0,6	28	<b>30216 A</b>	3EB	145	0,43	1,4	177	0,8
	140	33	28	35,25	2,5	2	0,6	30	<b>32216 A</b>	3EC	180	0,43	1,4	232	0,8
85	140	46	35	46	2,5	2	0,6	35	<b>33216</b>	3EE	250	0,43	1,41	380	0,78
	170	39	33	42,5	3	2,5	1	33	<b>30316 A</b>	2GB	277	0,35	1,7	329	0,9
	170	39	27	42,5	3	2,5	1	52	<b>31316 A</b>	7GB	222	0,83	0,7	275	0,4
	170	58	48	61,5	3	2,5	1	41	<b>32316 A</b>	2GD	383	0,35	1,7	503	0,9
	130	29	22	29	1,5	1,5	0,6	28	<b>32017 XA</b>	4CC	136	0,44	1,4	213	0,8
	130	36	29,5	36	1,5	1,5	0,6	26	<b>33017</b>	2CE	184	0,29	2,06	315	1,13
	140	41	32	41	2,5	2	0,6	33	<b>33117</b>	3DE	221	0,41	1,48	350	0,81
	150	28	24	30,5	2,5	2	0,6	30	<b>30217 A</b>	3EB	167	0,43	1,4	206	0,8

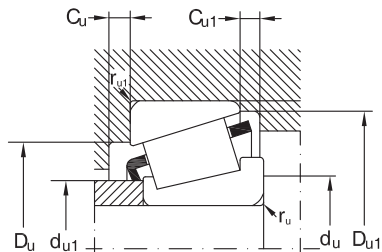

Speed limit		Mass	Mounting dimensions								
grease	oil		d <sub>u1</sub> max.	d <sub>u</sub> min.	D <sub>u</sub>		D <sub>u1</sub> min.	C <sub>u</sub> min.	C <sub>u1</sub> min.	r <sub>u</sub> max.	r <sub>u1</sub> max.
					min.	max.					
min <sup>-1</sup>		Kg									
3400	4500	0,62	72	72	90	93	97	4	5,5	1,5	1,5
3400	4500	0,76	72	72	89	93	96	5	6	1,5	1,5
3000	4000	1,31	73	72	96	103	106	6	7,5	1,5	1,5
3000	4000	1,1	77	74	106	111	113	4	4,5	2	1,5
3000	4000	1,48	76	74	104	111	115	4	5,5	2	1,5
3000	4000	2,02	74	74	102	111	115	6	9	2	1,5
2600	3600	2,3	83	77	122	128	130	5	8	3	2,5
2200	3200	2,25	79	77	111	128	132	5	13	3	2,5
2400	3400	3,49	80	77	117	128	130	6	12	3	2,5
3200	4300	0,83	78	77	98	103	105	5	6	1,5	1,5
3200	4300	1,14	78	77	99	103	105	5	5,5	1,5	1,5
3000	4000	1,71	79	79	104	111	115	6	8	2	1,5
3000	4000	1,22	81	79	110	116	118	4	5	2	1,5
2800	3800	1,56	80	79	108	116	119	4	6	2	1,5
2800	3800	2,06	79	79	107	116	120	7	9	2	1,5
2400	3400	3	89	82	130	138	140	5	8	3	2,5
2000	3000	2,82	84	82	118	138	141	5	13	3	2,5
2200	3200	4,1	86	82	125	138	140	6	12	3	2,5
3000	4000	0,88	83	82	103	108	110	5	6	1,5	1,5
3000	4000	1,16	83	82	104	108	110	6	5,5	1,5	1,5
2800	3800	1,79	84	84	109	116	120	6	8	2	1,5
2800	3800	1,33	86	84	115	121	124	4	5	2	1,5
2600	3600	2,62	85	84	115	121	124	4	6	2	1,5
2600	3600	2,47	83	84	111	121	125	7	10	2	1,5
2600	3600	3,4	95	87	139	148	149	5	9	3	2,5
1900	2800	3,5	91	87	127	148	151	6	14	3	2,5
2000	3000	5	91	87	133	148	149	7	13	3	2,5
2600	3600	1,24	89	87	112	117	120	6	7	1,5	1,5
2600	3600	1,67	90	87	112	117	119	6	6,5	1,5	1,5
2400	3400	1,9	89	89	114	121	126	6	8	2	1,5
2400	3400	1,59	91	90	124	130	132	4	6	2,5	2
2400	3400	2	90	90	122	130	134	5	7	2,5	2
2400	3400	2,93	89	90	119	130	135	7	11	2,5	2
2000	3000	4	102	92	148	158	159	5	9,5	3	2,5
1900	2800	4,07	97	92	134	158	159	6	15,5	3	2,5
1900	2800	5,9	98	92	142	158	159	7	13,5	3	2,5
2400	3400	1,3	94	92	117	122	125	6	7	1,5	1,5
2400	3400	1,75	94	92	118	122	125	6	6,5	1,5	1,5
2200	3200	2,38	95	95	122	130	135	7	9	2,5	2
2200	3200	2	97	95	132	140	141	5	6,5	2,5	2



Tapered roller bearings, single row

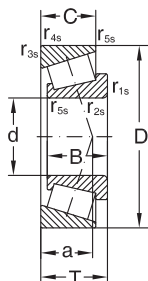

Dimensions									Designation	ISO series	Basic radial load. Factors				
d	D	B	C	T	r <sub>1s,2s</sub> min.	r <sub>3s,4s</sub> min.	r <sub>5</sub> min.	a			dyn. C <sub>r</sub>	e	γ	stat C <sub>0r</sub>	Y <sub>0</sub>
mm											kN	-	-	kN	-
85	150	36	30	38,5	2,5	2	0,6	33	<b>32217 A</b>	3EC	213	0,43	1,4	283	0,8
	150	49	37	49	2,5	2	0,6	37	<b>33217</b>	3EE	295	0,42	1,43	435	0,79
	180	41	34	44,5	4	3	1	35	<b>30317 A</b>	2GB	298	0,35	1,7	354	0,9
	180	41	28	44,5	4	3	1	55	<b>31317 A</b>	7GB	245	0,83	0,7	298	0,4
	180	60	49	63,5	4	3	1	42	<b>32317 A</b>	2GD	400	0,35	1,7	555	0,9
90	140	32	24	32	2	1,5	0,6	30	<b>32018 XA</b>	3CC	159	0,43	1,4	246	0,8
	140	39	32,5	39	2	1,5	0,6	28	<b>33018</b>	2CE	216	0,27	2,23	365	1,23
	150	45	35	45	2,5	2	0,6	36	<b>33118</b>	3DE	265	0,4	1,51	420	0,83
	160	30	26	32,5	2,5	2	0,6	31	<b>30218 A</b>	3FB	190	0,43	1,4	238	0,8
	160	40	34	42,5	2,5	2	0,6	36	<b>32218 A</b>	3FC	251	0,43	1,4	340	0,8
	190	43	36	46,5	4	3	1	36	<b>30318 A</b>	2GB	328	0,35	1,7	394	0,9
	190	43	30	46,5	4	3	1	57	<b>31318 A</b>	7GB	270	0,83	0,7	330	0,4
	190	64	53	67,5	4	3	1	44	<b>32318 A</b>	2GD	461	0,35	1,7	612	0,9
95	145	32	24	32	2	1,5	0,6	31	<b>32019 XA</b>	4CC	163	0,44	1,4	257	0,8
	145	39	32,5	39	2	1,5	0,6	29	<b>33019</b>	2CE	221	0,28	2,16	380	1,19
	170	32	27	34,5	3	2,5	1	33	<b>30219 A</b>	2FB	210	0,43	1,4	264	0,8
	170	43	37	45,5	3	2,5	1	39	<b>32219 A</b>	3FC	281	0,43	1,4	390	0,8
	200	45	38	49,5	4	3	1	39	<b>30319 A</b>	2GB	350	0,35	1,7	449	0,9
	200	45	32	49,5	4	3	1	60	<b>31319 A</b>	7GB	300	0,83	0,7	365	0,4
	200	67	55	71,5	4	3	1	47	<b>32319 A</b>	2GD	500	0,35	1,7	670	0,9
100	150	32	24	32	2	1,5	0,6	32	<b>32020 XA</b>	4CC	171	0,46	1,3	277	0,7
	150	39	32,5	39	2	1,5	0,6	29	<b>33020</b>	2CE	225	0,29	2,09	395	1,15
	180	34	29	37	3	2,5	1	35	<b>30220 A</b>	3FB	238	0,43	1,4	303	0,8
	180	46	39	49	3	2,5	1	41	<b>32220 A</b>	3FC	320	0,43	1,4	444	0,8
	180	63	48	63	3	2,5	1	46	<b>33220</b>	3FE	430	0,4	1,48	660	0,82
	215	47	39	51,5	4	2	1	40	<b>30320 A</b>	2GB	404	0,35	1,7	492	0,9
	215	73	60	77,5	4	3	1	53	<b>32320 A</b>	2GD	578	0,35	1,7	780	0,9
	160	35	26	35	2,5	2	0,6	34	<b>32021 XA</b>	4DC	204	0,44	1,4	334	0,8
105	160	43	34	43	2,5	2	0,6	31	<b>33021</b>	2DE	265	0,28	2,12	450	1,17
	190	36	30	39	3	2,5	1	37	<b>30221 A</b>	3FB	270	0,43	1,4	350	0,8
	190	50	43	53	3	2,5	1	44	<b>32221 A</b>	3FC	358	0,43	1,4	510	0,8
	225	77	63	81,5	4	3	1	53	<b>33221 A</b>	2GD	405	0,35	1,7	815	0,9
110	170	38	29	38	2,5	2	0,6	36	<b>32022 XA</b>	4DC	235	0,43	1,4	382	0,8
	170	47	37	47	2,5	2	0,6	33	<b>33022</b>	2DE	295	0,29	2,09	520	1,15
	180	56	43	56	2,5	2	0,6	44	<b>31122</b>	3EE	370	0,42	1,43	630	0,79
	200	38	32	41	3	2,5	1	39	<b>30222 A</b>	3FB	304	0,43	1,4	396	0,8
	200	53	46	56	3	2,5	1	46	<b>32222 A</b>	3FC	406	0,43	1,4	580	0,8
	240	50	42	54,5	4	3	1	43	<b>30322 A</b>	2GB	479	0,35	1,7	588	0,9
	240	80	65	84,5	4	3	1	55	<b>32322 A</b>	2GD	699	0,35	1,7	956	0,9
120	180	38	29	38	2,5	2	0,6	39	<b>32024 XA</b>	4DC	238	0,46	1,3	397	0,7

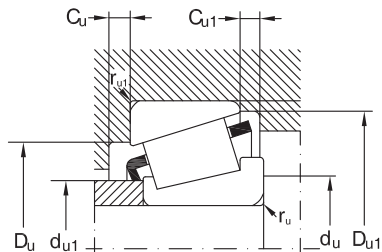

Speed limit		Mass	Mounting dimensions								
grease	oil		du1 max.	du min.	Du		Du1 min.	Cu min.	Cu1 min.	ru max.	ru1 max.
					min.	max.					
min <sup>-1</sup>		Kg									
2200	3200	2,5	96	95	130	140	142	5	8,5	2,5	2
2200	3200	3,58	95	95	128	140	144	7	12	2,5	2
1900	2800	4,7	107	99	156	166	167	6	10,5	4	3
1800	2600	5,08	103	99	143	166	169	6	16,5	4	3
1800	2600	6,85	103	99	150	166	167	8	14,5	4	3
2200	3200	1,7	100	99	125	131	134	6	8	2	1,5
2200	3200	2,48	100	99	127	131	135	7	6,5	2	1,5
2200	3000	3,19	100	100	130	140	144	7	10	2,5	2
2200	3000	2,49	103	100	140	150	150	5	6,5	2,5	2
2000	3000	3,3	102	100	138	150	152	5	8,5	2,5	2
1700	2400	5,5	113	104	165	176	176	6	10,5	4	3
1700	2400	5,92	109	104	151	176	179	6	16,5	4	3
1700	2400	8,21	108	104	157	176	177	8	14,5	4	3
2200	3200	1,8	105	104	130	136	140	6	8	2	1,5
2200	3200	2,33	104	104	131	136	139	7	6,5	2	1,5
1900	2800	2,96	110	107	149	158	159	5	7,5	3	2,5
1900	2800	4	108	107	145	158	161	5	8,5	3	2,5
1800	2600	6,7	118	109	172	186	184	6	11,5	4	3
1700	2400	6,95	114	109	157	186	187	6	17,5	4	3
1700	2400	11	115	109	166	186	186	8	16,5	4	3
2000	3000	1,85	109	109	134	141	144	6	8	2	1,5
2000	3000	2,42	108	109	135	141	143	7	6,5	2	1,5
1900	2800	3,54	116	112	157	168	168	5	8	3	2,5
1800	2600	4,76	114	112	154	168	171	5	10	3	2,5
1800	2600	6,77	112	112	151	168	172	10	15	3	2,5
1700	2400	7,9	127	114	184	201	197	6	12,5	4	3
1600	2200	14	123	114	177	201	200	8	17,5	4	3
1900	2800	2,42	116	115	143	150	154	6	9	2,5	2
1900	2800	3,34	116	115	145	150	153	7	9	2,5	2
1800	2600	4,26	122	117	165	178	177	6	9	3	2,5
1800	2600	5,9	120	117	161	178	180	5	10	3	2,5
1500	2000	14,5	128	119	185	211	209	9	18,5	4	3
1800	2600	3,06	122	120	152	160	163	7	9	2,5	2
1800	2600	4,16	123	120	152	160	161	7	10	2,5	2
1700	2400	5,54	121	120	155	170	174	9	13	2,5	2
1700	2400	5	129	122	174	188	187	6	9	3	2,5
1700	2400	6,9	126	122	170	188	190	6	10	3	2,5
1600	2200	12,5	141	124	206	226	220	8	12,5	4	3
1400	1900	16,4	137	124	198	226	222	9	19,5	4	3
1700	2400	3,25	131	130	161	170	173	7	9	2,5	2



### Tapered roller bearings, single row

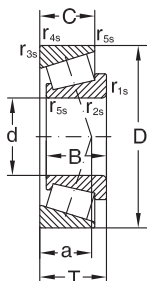

Dimensions									Designation	ISO series	Basic radial load. Factors				
d	D	B	C	T	r <sub>1s,2s</sub> min.	r <sub>3s,4s</sub> min.	r <sub>5</sub> min.	a			dyn. C <sub>r</sub>	e	Y	stat C <sub>0r</sub>	Y <sub>0</sub>
mm											kN	-	-	kN	-
120	180	48	38	48	2,5	2	0,6	36	<b>33024</b>	2DE	310	0,31	1,97	560	1,08
	215	40	34	43,5	3	2,5	1	43	<b>30224 A</b>	4FB	340	0,43	1,4	459	0,8
	215	58	50	61,5	3	2,5	1	51	<b>32224 A</b>	4FD	446	0,43	1,4	653	0,8
	260	55	46	59,5	4	3	1	47	<b>30324 A</b>	2GB	568	0,35	1,7	712	0,9
	260	86	69	90,5	4	3	1	60	<b>32324 A</b>	2GD	799	0,35	1,7	1104	0,9
130	200	45	34	45	2,5	2	0,6	42	<b>32026 XA</b>	4EC	315	0,43	1,4	526	0,8
	230	40	34	43,75	4	3	1	45	<b>30226 A</b>	4FB	367	0,43	1,4	485	0,8
	230	64	54	67,75	4	3	1	56	<b>32226 A</b>	4FD	551	0,43	1,4	836	0,8
	280	58	49	63,75	5	4	1,5	51	<b>30326 A</b>	2GB	640	0,35	1,7	820	0,9
	280	66	44	72	5	4	1,5	87	<b>31326 XA</b>	7GB	597	0,83	0,7	761	0,4
	280	93	78	98,75	5	4	1,5	66	<b>32326 A</b>	-	947	0,35	1,7	1333	0,9
140	210	45	34	45	2,5	2	0,6	46	<b>32028 XA</b>	4DC	312	0,46	1,3	529	0,7
	250	42	36	45,75	4	3	1	47	<b>30228 A</b>	4FB	396	0,43	1,4	527	0,8
	250	68	58	71,75	4	3	1	60	<b>32228 A</b>	4FD	602	0,43	1,4	907	0,8
	300	70	47	77	5	4	1,5	90	<b>31328 XA</b>	7GB	714	0,83	0,7	935	0,4
150	225	48	36	48	3	2,5	1	49	<b>32030 XA</b>	4EC	355	0,46	1,3	620	0,7
	225	59	46	59	3	2,5	1	48	<b>33030</b>	2EE	465	0,36	1,65	880	0,9
	270	45	38	49	4	3	1	50	<b>30230 A</b>	4GB	457	0,43	1,4	618	0,8
	270	73	60	77	4	3	1	64	<b>32230 A</b>	4GD	705	0,43	1,4	1080	0,8
160	240	51	38	51	3	2,5	1	52	<b>32032 XA</b>	4EC	402	0,46	1,3	696	0,7
	290	48	40	52	4	3	1	54	<b>30232 A</b>	4GB	520	0,43	1,4	710	0,8
	290	80	67	84	4	3	1	70	<b>32232 A</b>	4GD	840	0,43	1,4	1400	0,8
170	230	38	30	38	2,5	2	0,6	42	<b>32934 A</b>	3DC	280	0,37	1,6	572	0,9
	260	57	43	57	3	2,5	1	56	<b>32034 XA</b>	4EC	480	0,44	1,4	865	0,8
	310	52	43	57	5	4	1,5	58	<b>30234 A</b>	4GB	610	0,43	1,4	844	0,8
	310	86	71	91	5	4	1,5	75	<b>32234 A</b>	4GD	889	0,43	1,4	1377	0,8
180	250	45	34	45	2,5	2	0,6	53	<b>32936 A</b>	4DC	350	0,48	1,3	727	0,7
	280	64	48	64	3	2,5	1	59	<b>32036 XA</b>	4FD	599	0,43	1,4	1037	0,8
	320	52	43	57	5	4	1,5	61	<b>30236 A</b>	4GB	584	0,46	1,3	825	0,7
	320	86	71	91	5	4	1,5	78	<b>32236 A</b>	4GD	974	0,46	1,3	1571	0,7
190	260	45	34	45	2,5	2	0,6	55	<b>32938 A</b>	4DC	358	0,48	1,3	772	0,7
	290	64	48	64	3	2,5	1	62	<b>32038 XA</b>	4FD	609	0,44	1,4	1077	0,8
	340	92	75	97	5	4	1,5	81	<b>32238 A</b>	4GD	1080	0,43	1,4	1860	8
200	280	51	39	51	3	2,5	1	53	<b>32940 A</b>	3EC	474	0,4	1,5	950	0,8
	310	70	53	70	3	2,5	1	66	<b>32040 XA</b>	4FD	716	0,43	1,4	1356	0,8
	310	70	53	70	3	2,5	1	66	<b>T32040 X</b>	4FD	716	0,43	1,4	1356	0,8
	310	70	53	70	3	2,5	1	66	<b>T32040 XP5</b>	4FD	716	0,43	1,4	1356	0,8
	360	98	82	104	5	4	1,5	83	<b>32240 A</b>	3GD	1220	0,4	1,5	2020	0,8
220	300	51	39	51	3	2,5	1	58	<b>32944 M</b>	3EC	407	0,43	1,4	827	0,8
	340	76	57	76	4	3	1	72	<b>32044 XA</b>	4FD	850	0,43	1,4	1537	0,8

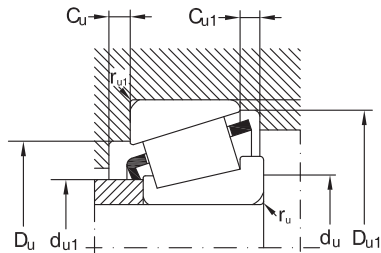

Speed limit		Mass	Mounting dimensions								
grease	oil		d <sub>u1</sub> max.	d <sub>u</sub> min.	D <sub>u</sub>		D <sub>u1</sub> min.	C <sub>u</sub> min.	C <sub>u1</sub> min.	r <sub>u</sub> max.	r <sub>u1</sub> max.
					min.	max.					
min <sup>-1</sup>		Kg									
1700	2400	4,55	132	130	160	170	171	6	10	2,5	2
1600	2200	6,01	140	132	187	203	201	6	9,5	3	2,5
1600	2200	8,59	136	132	181	203	204	7	11,5	3	2,5
1500	2000	13,6	152	134	221	246	237	10	13,5	4	3
1300	1800	24,5	148	134	213	246	239	9	21,5	4	3
1600	2200	4,93	144	140	178	190	192	8	11	2,5	2
1500	2000	7,6	152	144	203	216	217	7	9,5	4	3
1500	2000	10,7	146	144	193	216	219	7	13,5	4	3
1300	1800	19,5	164	148	239	262	255	8	14,5	5	4
1200	1700	18,6	157	148	218	262	261	9	28	5	4
1100	1600	27,6	160	148	230	262	260	10	20,5	5	4
1600	2200	5,23	153	150	187	200	202	8	11	2,5	2
1400	1900	8,5	163	154	219	236	234	9	9,5	4	3
1400	1900	13,9	159	154	210	236	238	8	13,5	4	3
1200	1700	23,9	169	158	235	282	280	9	30	5	4
1500	2000	6,35	164	162	200	213	216	8	12	3	2,5
1500	2000	8,23	164	162	200	213	217	8	13	3	2,5
1300	1800	10,7	175	164	234	256	250	9	11	4	3
1200	1700	17,9	171	164	226	256	254	8	17	4	3
1300	1800	7,75	175	172	213	228	231	8	13	3	2,5
1100	1600	13,6	189	174	252	276	269	9	12	4	3
1100	1600	25,5	183	174	242	276	274	10	17	4	3
1400	1900	4,5	183	180	213	220	222	7	8	2,5	2
1200	1700	10,5	187	182	230	248	249	10	14	3	2,5
1000	1500	19	203	188	269	292	288	8	14	5	4
1000	1500	29,3	196	188	259	292	294	10	20	5	4
1200	1700	6,65	193	190	225	240	241	8	11	2,5	2
1100	1600	14,5	199	192	247	268	267	10	16	3	2,5
1000	1500	20	211	198	278	302	297	9	14	5	4
950	1400	27,4	204	198	267	302	303	10	20	5	4
1100	1600	7	204	200	235	249	251	8	11	2,5	2
1000	1500	15	209	202	257	278	279	10	16	3	2,5
900	1300	39,5	216	207	286	322	323	10	22	5	4
1000	1500	9,5	216	212	257	268	271	9	12	3	2,5
950	1400	19,5	221	212	273	298	297	11	17	3	2,5
950	1400	19,5	221	212	273	298	297	11	17	3	2,5
950	1400	19,5	221	212	273	298	297	11	17	3	2,5
900	1300	33	226	217	302	342	340	11	22	5	4
950	1400	11,2	234	232	275	288	290	9	12	3	2,5
900	1300	25,5	243	234	300	326	326	12	19	4	3



### Tapered roller bearings with flanged outer ring

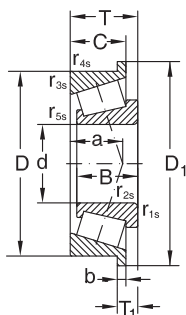

Dimensions												Designation
d	D	B	C	T	$r_{1s,2s}$ min.	$r_{3s,4s}$ min.	$r_5$ min.	$T_1$	$D_1$	$C_1$	a	
mm												
20	47	14	12	15,25	1	1	0,3	6,25	51	3	11	30204 AR
25	52	15	13	16,25	1	1	0,3	6,75	57	3,5	12	30205 AR
30	62	16	14	17,25	1	1	0,3	6,75	67	3,5	14	30206 AR
	62	20	17	21,25	1	1	0,3	8,25	67	4	15	32206 AR
	72	19	16	20,75	1,5	1,5	0,6	8,75	77	4	15	30306 AR
35	72	27	23	28,75	1,5	1,5	0,6	11,75	77	6	18	32306 AR
	72	17	15	18,25	1,5	1,5	0,6	7,25	77	4	15	30207 AR
	72	23	19	24,75	1,5	1,5	0,6	10,25	77	4,5	17	32207 AR
	80	21	18	22,75	2	1,5	0,6	8,25	85	4,5	16	30307 AR
40	80	31	25	32,75	2	1,5	0,6	13,75	85	6	20	32307 AR
	80	18	16	19,75	1,5	1,5	0,6	7,75	85	4	16	30208 AR
	80	23	19	24,75	1,5	1,5	0,6	10,25	85	4,5	19	32208 AR
	90	23	20	25,25	2	1,5	0,6	9,75	95	4,5	19	30308 AR
45	90	33	27	35,25	2	1,5	0,6	14,25	95	6	23	32308 AR
	85	19	16	20,75	1,5	1,5	0,6	8,75	90	4	18	30209 AR
	85	23	19	24,75	1,5	1,5	0,6	10,25	90	4,5	20	32209 AR
	100	25	22	27,25	2	1,5	0,6	10,25	106	5	21	30309 AR
50	100	36	30	38,25	2	1,5	0,6	15,25	106	7	25	32309 AR
	90	20	17	21,75	1,5	1,5	0,6	8,75	95	4	19	30210 AR
	90	23	19	24,75	1,5	1,5	0,6	10,25	95	4,5	21	32210 AR
	110	27	23	29,25	2,5	2	0,6	11,25	116	5	23	30310 AR
55	110	40	33	42,25	2,5	2	0,6	17,25	116	8	28	32310 AR
	100	21	18	22,75	2	1,5	0,6	9,25	106	4,5	20	30211 AR
	100	25	21	26,75	2	1,5	0,6	10,75	106	5	22	32211 AR
60	120	43	35	45,5	2,5	2	0,6	18,5	127	8	29	32311 AR
	110	22	19	23,75	2	1,5	0,6	9,25	116	4,5	22	30212 AR
	110	28	24	29,75	2	1,5	0,6	10,75	116	5	24	32212 AR
65	130	46	37	48,5	3	2,5	1	19,5	137	8	31	32312 AR
	120	23	20	24,75	2	1,5	0,6	9,25	127	4,5	23	30213 AR
70	120	31	27	32,75	2	1,5	0,6	11,75	127	6	26	32213 AR
	125	24	21	26,25	2	1,5	0,6	10,25	132	5	25	30214 AR
	125	31	27	33,25	2	1,5	0,6	12,25	132	6	28	32214 AR



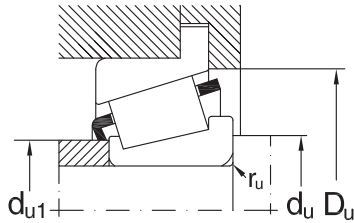

ISO series	Basic radial load. Factors					Speed limit		Mass	Mounting dimensions			
	dyn. C <sub>r</sub>	e	γ	stat C <sub>0r</sub>	Y <sub>0</sub>	grease	oil		d <sub>u1</sub> max.	d <sub>u</sub> min.	D <sub>u</sub> min.	r <sub>u</sub> max.
	kN	-	-	kN	-	min <sup>-1</sup>			Kg			
2DB	26	0,35	1,7	29	0,9	8000	11000	0,127	27	26	43	1
3CC	29,5	0,37	1,6	36	0,9	7500	10000	0,161	31	31	48	1
3DB	38	0,37	1,6	48	0,9	6300	8500	0,233	37	36	57	1
3DC	47,5	0,37	1,6	65	0,9	6300	8500	0,29	37	36	59	1
2FB	53	0,31	1,9	65	1,1	5600	7500	0,398	39	37	66	1,5
2FD	72,3	0,31	1,9	97	1,1	5600	7000	0,577	40	37	66	1,5
3DB	49,4	0,37	1,6	58	0,9	5300	7000	0,338	44	42	67	1,5
3DC	61,6	0,37	1,6	80	0,9	5300	7000	0,422	43	42	67	1,5
2FB	68,2	0,31	1,9	83	1,1	5000	6700	0,543	45	44	74	2
2FE	88,2	0,31	1,9	120	1,1	4800	6300	0,76	44	44	74	2
3DB	58,5	0,37	1,6	70	0,9	4800	6300	0,44	49	47	74	1,5
3DC	71	0,37	1,6	95	0,9	4800	6300	0,533	48	47	75	1,5
2FB	81	0,35	1,7	105	0,9	4500	6000	0,725	52	49	82	2
2FD	110	0,35	1,7	156	0,9	4000	5300	1,027	50	49	82	2
3DB	63	0,4	1,5	83	0,8	4500	6000	0,491	54	52	80	1,5
3DC	75	0,4	1,5	103	0,8	4500	6000	0,584	53	52	80	1,5
2FB	101	0,35	1,7	130	0,9	4000	5300	0,958	59	54	92	2
2FD	132	0,35	1,7	188	0,9	3600	4800	1,3	56	54	93	2
3DB	70,5	0,43	1,4	95	0,8	4300	5600	0,552	58	57	85	1,5
3DC	76,5	0,43	1,4	106	0,8	4300	5600	0,625	58	57	85	1,5
2FB	120	0,35	1,7	156	0,9	3600	4800	1,23	65	60	102	2,5
2FD	165	0,35	1,7	239	0,9	3200	4300	1,89	62	60	102	2,5
3DB	84,5	0,4	1,5	112	0,8	3800	5000	0,724	64	64	94	1,5
3DC	99	0,4	1,5	138	0,8	3800	5000	0,858	63	64	95	1,5
2FD	187	0,35	1,7	276	0,9	3000	4000	2,29	68	65	111	2
2EB	91,5	0,4	1,5	122	0,8	3400	4500	0,897	70	69	103	2
2EC	120	0,4	1,5	170	0,8	3400	4500	1,14	69	69	104	2
2FD	216	0,35	1,7	318	0,9	2600	3600	1,92	74	72	120	3
3EB	110	0,4	1,5	147	0,8	3000	4000	1,14	77	74	113	2
3EC	142	0,4	1,5	206	0,8	3000	4000	1,54	76	74	115	2
3EB	120	0,43	1,4	163	0,8	3000	4000	1,27	81	79	118	2
3EC	150	0,43	1,4	220	0,8	2800	3800	1,62	80	79	119	2



**Tapered roller bearings, single row**  
inch dimensions

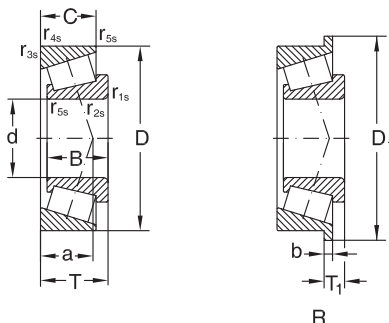

Dimensions									Designation
d	D	B	C	T / T <sub>1</sub>	r <sub>1s,2s</sub> min.	r <sub>3s,4s</sub> min.	D <sub>1</sub>	a	
mm									
<b>11,112</b>	34,988	10,988	8,730	10,998	1,3	1,3		9	<b>A4044/A4138</b>
<b>12,700</b>	34,988	10,988	8,730	10,998	1,3	1,3		9	<b>A4050/A4138</b>
<b>14,989</b>	34,988	10,988	8,730	10,998	0,8	1,3		9	<b>A4059/A4138</b>
<b>15,875</b>	42,862	16,670	13,495	16,670	1,5	1,5			<b>17580/17520</b>
<b>17,462</b>	39,878	14,605	10,668	13,843	1,3	1,3		9	<b>LM11749/LM11710</b>
<b>19,050</b>	39,992	11,153	9,525	12,014	1	1,3			<b>A6075/A6157</b>
	45,237	16,637	12,065	15,494	1,3	1,3		10	<b>LM11949/LM11910</b>
	49,225	19,050	14,288	18,034	1,3	1,3		11	<b>09067/09195</b>
<b>21,430</b>	50,005	18,288	13,970	17,526	1,3	1,3		11	<b>M12649/M12610</b>
	45,237	16,637	12,065	15,494	1,3	1,3		10	<b>LM12749/LM12710</b>
<b>21,987</b>	45,974	16,637	12,065	15,494	1,3	1,3		10	<b>LM12749/LM12711</b>
	56,896	19,837	15,875	19,368	1,3	1,3			<b>1755/1729</b>
<b>23,812</b>	56,896	19,837	15,875	19,368	0,8	1,3		12,5	<b>1779/1729</b>
<b>25,000</b>	51,994	14,260	12,700	15,011	1,5	1,3		12	<b>07097/07204</b>
	51,994	14,260	12,700	15,011	1,5	1,3			<b>07100S/07204</b>
	50,005	14,260	9,525	13,495	1,5	1			<b>07097/07196</b>
	50,005	14,260	9,525	13,495	1	1		11	<b>07100/07196</b>
	50,292	14,732	10,668	14,224	1,3	1,3		11	<b>L44643/L44610</b>
	57,150	19,431	14,732	19,431	1,5	1,5		16,3	<b>M84548/M84510</b>
	61,912	20,638	14,288	19,050	0,8	2			<b>15101/15243</b>
	62,000	20,638	14,288	19,050	3,5	1,3		13,3	<b>15100/15245</b>
	62,000	20,638	14,288	19,050	0,8	1,3		13,3	<b>15101/15245</b>
<b>26,988</b>	50,292	14,732	10,668	14,224	3,5	1,3		11	<b>L44649/L44610</b>
<b>28,575</b>	68,262	22,225	17,462	22,225	0,8	1,5		17,1	<b>02474/02420</b>
<b>29,000</b>	50,292	14,732	10,668	14,224	3,5	1,3		11	<b>L45449/L45410</b>
<b>30,162</b>	64,292	21,433	16,670	21,433	1,5	1,5		18,2	<b>M86649/M86610</b>
<b>30,226</b>	69,012	19,583	15,875	19,845	0,8	1,3		15,9	<b>14116/14276</b>
	59,131	16,764	11,811	15,875	*	1,3		13	<b>LM67048/LM67010</b>
	62,000	19,050	14,288	18,161	3,5	1,3		13	<b>15123/15245</b>
	68,262	22,225	17,462	22,225	3,5	1,5		17,1	<b>02475/02420</b>
	69,012	19,583	15,875	19,845	3,5	1,3		15,9	<b>14125A/14276</b>
	69,012	19,583	15,875	19,845	0,8	1,3			<b>14124/14276</b>
<b>33,338</b>	68,262	22,225	17,462	22,225	0,8	1,5		19,2	<b>M88048/M88010</b>
	76,200	28,575	23,020	29,370	0,8	3,3		23,8	<b>HM89443/HM89410</b>
<b>34,925</b>	65,088	18,288	13,970	18,034	*	1,3		14	<b>LM48548/LM48510</b>
	69,012	26,721	15,875	26,982	0,8	1,3		15,9	<b>14136A/14276</b>
	72,233	25,400	19,842	25,400	2,3	2,3		21	<b>HM88649/HM88610</b>
	76,200	28,575	23,020	29,370	3,5	3,3		23	<b>HM89446/HM894410</b>

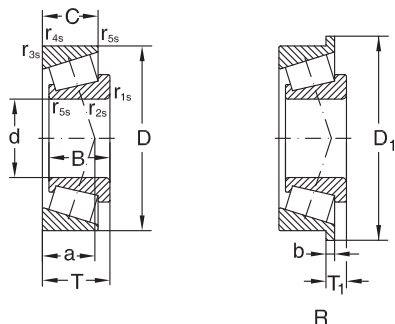

Basic radial load. Factors					Speed limit		Mass
dyn. $C_r$	e	Y	stat $C_{0r}$	$Y_0$	grease	oil	
kN	-	-	kN	-	min <sup>-1</sup>		Kg
12	0,45	1,3	11,85	0,7	11000	15000	0,055
12	0,45	1,3	11,85	0,7	10000	15000	0,058
12	0,45	1,3	11,85	0,7	10000	14000	0,063
29,1	0,33	1,81	29,2	1	9800	13000	0,11
19,8	0,29	2,1	21,1	1,2	8500	12000	0,081
12,4	0,53	1,14	12,3	0,63	10000	13000	0,07
25,5	0,3	2	25,104	1,1	7500	11000	0,123
31,1	0,27	2,3	33,1	1,2	7000	10000	0,16
34,1	0,28	2,2	38	1,2	7000	10000	0,16
25,2	0,31	2	27,7	1,1	7500	10000	0,122
25,2	0,31	2	27,7	1,1	7000	10000	0,123
42	0,31	1,9	45,3	1,07	7200	9600	0,24
42	0,31	1,9	45,3	1,07	7200	9600	0,24
23,7	0,4	1,5	27,5	0,8	6300	9000	0,14
27	0,4	1,5	29,6	0,8	6300	9500	0,14
27	0,4	1,5	29,6	0,8	6300	9000	0,11
23,7	0,4	1,5	27,5	0,8	6300	9500	0,115
23,4	0,37	1,6	25,913	0,9	6300	9000	0,125
44,9	0,55	1,1	52,9	0,6	6900	9200	0,23
46,8	0,35	1,71	53,9	0,9	6100	8200	0,29
46,8	0,35	1,71	53,9	0,94	6100	8200	0,29
46,8	0,35	1,7	53,9	0,9	6100	8200	0,29
23,4	0,37	1,6	25,913	0,9	6300	9000	0,115
59,1	0,42	1,44	70,2	0,79	5800	7700	0,4
24,1	0,37	1,6	32,2	0,9	6300	9000	0,115
55,7	0,55	1,1	71,7	0,6	6100	8100	0,33
50,6	0,38	1,57	61,7	0,86	5600	7400	0,36
31,1	0,41	1,5	35,912	0,8	5300	7500	0,18
43,9	0,35	1,7	49,708	0,9	5300	7500	0,228
59,1	0,42	1,44	70,2	0,79	5800	7700	0,37
50,6	0,38	1,57	61,7	0,86	5600	7400	0,34
50,6	0,38	1,57	61,7	0,86	5600	7400	0,35
59,6	0,55	1,1	77,4	0,6	5700	7500	0,37
86,2	0,55	1,1	119	0,6	5100	6800	0,66
42,9	0,38	1,6	50,696	0,9	4800	7000	0,248
50,6	0,38	1,57	61,7	0,86	5600	7400	0,36
66,5	0,55	1,1	86,61	0,6	4500	6700	0,487
72,5	0,55	1,1	97,9	0,6	4500	6300	0,57



**Tapered roller bearings, single row**  
inch dimensions

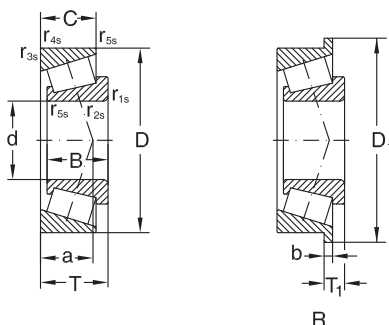

Dimensions									Designation
d	D	B	C	T / T <sub>1</sub>	r <sub>1s,2s</sub> min.	r <sub>3s,4s</sub> min.	D <sub>1</sub>	a	
mm									
34,987	59,131	16,764	11,938	15,875	*	1,3		13	L68149/L68110
	59,974	16,764	11,938	15,875	*	1,3		13	L68149/L68111
36,512	76,200	28,575	23,020	29,370	3,5	3,3		23,8	HM89449/HM89410
	76,200	28,575	23,020	29,370	3,5	0,8			HM89449/HM89411
38,000	63,000	17,000	13,500	17,000	*	1,3		14	JL69349/JL69310
	65,088	18,288	13,970	18,034	2,3	1,3		13	LM29749/LM29710
38,100	69,012	19,050	15,083	19,050	3,5	2,3		15,9	13685/13621
	79,375	29,771	23,812	29,370	3,5	3,3		20	3490/3420
	73,025	22,098	21,336	25,654	0,8	2,3		18	M201047/M201011
40,987	67,975	18,000	13,500	17,500	3,5	1,5		13,8	LM300849/LM300811
	73,431	19,812	16,604	21,430	3,5	0,8		18,1	LM501349/LM501314
41,275	73,431	19,812	14,732	19,559	3,5	0,8		16	LM501349/LM501310
	76,200	17,384	14,880	18,009	1,5	1,5		17,1	11162/11300
	73,025	18,258	15,083	18,258	1,5	1,5		14	L102849/L102810
	82,931	25,400	19,050	23,812	3,5	0,8		18	25580/25520
44,450	82,931	25,400	19,050	23,812	0,5	0,8		17,4	25581/25520
	88,900	29,370	23,020	30,162	3,5	3,3		25,5	HM803149/HM803110
	95,250	28,575	22,225	27,783	0,8	0,8		20	33885/33822
	95,250	28,575	22,225	30,958	3,5	0,8		31,4	HM903249/HM903210
	104,775	36,512	28,575	36,512	3,5	3,3		28,8	HM807040/HM807010
	107,950	29,317	22,225	27,783	3,5	0,8		20	460/453 A
	73,431	19,812	15,748	19,558	3,5	0,8		15	LM102949/LM102910
45,242	77,788	19,842	15,080	19,842	3,5	0,8		17,3	LM603049/LM603011
	82,931	25,400	19,050	23,812	3,5	0,8		18	25590/25520
45,618	82,931	25,400	22,225	26,988	3,5	2,3		19	25590/25523
	85,000	25,608	20,638	25,400	0,8	1,3		19	2984 A/2924
47,625	93,264	30,302	23,812	30,162	3,5	3,3		21	3779/3730
	104,775	36,512	28,575	36,512	3,5	3,3		28,8	HM807044/HM807010
49,212	103,188	44,475	36,512	43,658	3,5	3,3		27,4	5395/5335
	82,000	21,500	17,000	21,500	3	0,5		16,3	JLM104948/JLM104910
50,000	90,000	28,000	23,000	28,000	3	2,5		20,6	JM205149/JM205110
	90,000	22,225	15,875	8,887	2		94,661	16	365/362 R
	82,550	22,225	16,510	21,590	3,5	1,3		16	LM104949/LM104911
50,800	92,075	25,400	19,845	24,608	3,5	0,8		20	28580/28521
	95,250	28,575	22,225	27,783	3,5	0,8		20	33889/33822
	97,630	24,608	19,446	9,124	3,5		101,549	21	28678/28622 R
	104,775	36,512	28,575	36,512	3,5	3,3		29,1	HM807046/HM807010
	111,125	26,909	20,638	30,162	3,5	3,3		37	55200 C/55437

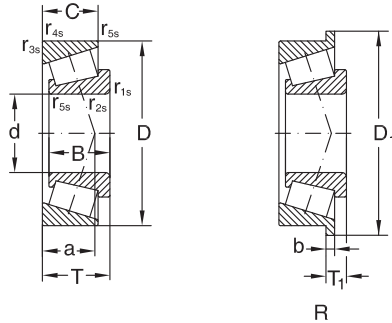

Basic radial load. Factors					Speed limit		Mass
dyn. $C_r$	e	Y	stat $C_{0r}$	$Y_0$	grease	oil	
kN	-	-	kN	-	min <sup>-1</sup>		Kg
30,1	0,42	1,4	38,841	0,8	5300	7500	0,17
30,1	0,42	1,4	38,841	0,8	5300	7500	0,18
86,2	0,55	1,1	119	0,6	5100	6800	0,62
86,2	0,55	1,1	119	0,6	5100	6800	0,63
32,9	0,42	1,4	43,8	0,8	4800	7000	0,221
38,4	0,33	1,8	48,72	1	4800	6700	0,227
52,5	0,4	1,49	67,9	0,82	5300	7100	0,28
79,3	0,36	1,6	103	0,9	4300	6000	0,55
57,5	0,33	1,8	72	1	4300	6300	0,46
46,1	0,35	1,72	63,5	0,95	5300	7000	0,23
58,4	0,4	1,5	74,2	0,83	5000	6600	0,34
48,6	0,4	1,5	64,3	0,8	4300	6000	0,32
44,5	0,49	1,23	55,1	0,68	4900	6500	0,33
47	0,32	1,9	68,9	1	4300	6000	0,3
75,7	0,33	1,8	95,1	1	3800	5600	0,554
83,8	0,33	1,8	111	1	3800	5600	0,56
105	0,55	1,1	144	0,6	4300	5800	0,84
120	0,33	1,8	161	1	3600	5000	0,98
107	0,74	0,81	132	0,45	3700	4900	1
159	0,49	1,23	223	0,68	3600	4800	1,62
96,8	0,33	1,8	127	1	3600	5000	0,97
97,8	0,34	1,8	134	1	3000	4500	0,31
59,6	0,43	1,41	77,9	0,77	4600	6200	0,36
48,5	0,31	2	66,4	1,1	4000	6000	0,3
70	0,33	1,8	95,2	1	3800	5300	0,55
70	0,33	1,8	95,2	1	3800	5300	0,58
68,3	0,35	1,7	97	1	3800	5300	0,6
159	0,49	1,23	223	0,68	3600	4800	1,52
182	0,3	2,02	246	1,97	3800	5100	1,72
75,2	0,31	1,97	104	1,08	4300	5700	0,41
115	0,33	1	154	1,82	4100	5400	0,74
98	0,34	1,8	128	1	3400	5000	0,905
74,3	0,32	1,9	87,26	1	3400	5000	0,554
65,2	0,31	2	86,2	1,1	3600	5300	0,411
71	0,38	1,6	103	0,9	3400	4800	0,69
102	0,33	1,8	135	1	3400	4800	0,86
159	0,49	1,23	223	0,68	3600	4800	1,49
118	0,88	0,68	161	0,37	3200	4200	1,34



**Tapered roller bearings, single row**  
inch dimensions

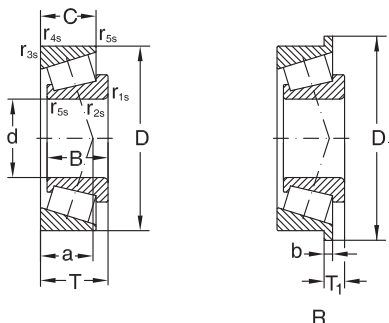

R

Dimensions									Designation
d	D	B	C	T / T <sub>1</sub>	r <sub>1s,2s</sub> min.	r <sub>3s,4s</sub> min.	D <sub>1</sub>	a	
mm									
53,975	104,775	36,512	28,575	36,512	3,5	3,3		28,8	HM807049/HM807010
	123,825	32,791	25,400	36,512	3,5	3,3			72212 C/72487
	123,825	32,791	25,400	17,462	3,5		130,073	37	72212/72487 R
55,562	123,825	32,791	25,400	36,512	3,5	3,3			72218 C/72487
	104,775	30,958	23,812	30,162	2,3	3,3			45290/45220
57,150	104,775	30,958	23,812	30,162	6,4	3,3			45291/45220
	104,775	29,317	24,605	30,162	2,3	3,3		23	462A/453 X
	107,950	29,317	22,225	27,783	3,5	0,8		20,7	469/453A
	110,000	29,317	27,000	27,795	3,5	2		24	462/454
	112,712	30,162	23,812	30,162	8	3,3		23	39581/39520
	123,825	36,678	30,162	38,100	3,5	3,3		28,4	555S/552A
	122,238	38,354	29,718	38,100	8	3,3		27,2	HM212044/HM212011
60,325	127,000	44,450	34,925	44,450	3,5	3,3		34,9	65237/65500
	127,000	36,512	26,988	36,512	3,5	3,3		32	HM813841/HM813810
	94,976	15,499	11,999	17,000	1	1		28	L910349/L910310
63,500	92,075	12,700	9,525	13,495	1,5	1,5		16	LL510749/LL510710
	94,458	19,050	15,083	19,050	1,5	1,5			L610549/L610510
	112,712	30,162	23,812	30,162	3,5	3,3		23	39585/39520
	112,712	30,048	23,812	30,162	3,5	0,8		25	3982/3928
	112,712	30,048	23,812	30,162	3,5	3,3		25	3982/3920
	112,712	30,048	23,812	11,112	3,5		117,373	25	3982/3920 R
	120,000	29,007	23,444	29,002	3,5	3,3		26	483/472 A
	122,238	38,354	29,718	38,100	7	3,3		27,2	HM212047/HM212011
	122,238	38,430	29,770	38,305	3,5	2		27	X3962/X3963
	110,000	25,400	19,050	25,400	3,5	1,3		24	29590/29521
66,675	122,238	38,354	29,718	38,100	3,5	3,3		27	HM212049/HM212011
	112,712	30,048	23,812	30,162	3,5	3,3		25	3984/3920
	110,000	25,000	20,500	26,000	1	2,5		20,5	JLM813049/JLM813010
71,438	120,000	32,545	26,195	32,545	3,5	3,3		25,8	47490/47420
	136,525	46,038	36,512	46,038	3,5	3,3		38	H715345/H715311
	127,000	36,170	28,575	36,512	3,5	3,3		28	567 A/563
73,025	127,000	36,170	28,575	36,512	3,5	3,3		28	567/563
	139,992	36,098	28,575	36,512	3,5	3,3		30,8	576/572
	146,050	41,275	31,750	41,275	3,5	3,3		34	657/653
76,200	133,350	33,338	26,195	33,338	3,5	3,3			47679/47620
	139,992	36,098	28,575	36,512	3,5	3,3		31	575/572
	149,225	54,229	44,450	53,975	9,7	3,3		38,8	6461 A/6420
	150,089	46,672	36,512	44,450	3,5	3,3		32,3	748S/742

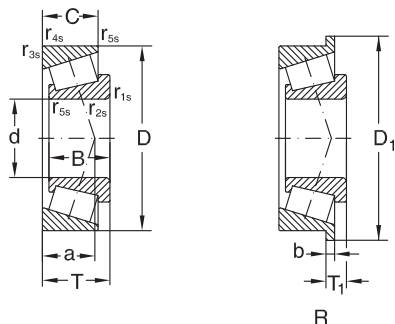

Basic radial load. Factors					Speed limit		Mass
dyn. $C_r$	e	Y	stat $C_{0r}$	$Y_0$	grease	oil	
kN	-	-	kN	-	min <sup>-1</sup>		Kg
159	0,49	1,23	223	0,68	3600	4800	1,41
167	0,74	0,81	208	0,45	2900	3900	2,12
143	0,74	0,8	162	0,4	2800	4000	2,1
167	0,74	0,81	208	0,45	2900	3900	2,08
142	0,33	1,8	189	1	3000	4300	1,08
142	0,33	1,8	189	1	3000	4300	1,06
97,8	0,34	1,8	134	1	3000	4500	1,1
126	0,34	1,79	166	1	3500	4700	1,09
109	0,34	1,8	139	1	3000	4300	1,22
130	0,34	1,8	196	1	2800	4000	1,03
177	0,35	1,73	248	1	3000	4100	2,14
209	0,34	1,78	279	0,98	3100	4100	1,99
225	0,49	1,23	297	0,68	3100	4200	2,66
161	0,5	1,2	226	0,7	2600	3800	2,16
42,3	0,78	0,8	56,8	0,4	3000	4500	0,4
31,2	0,4	1,5	46	0,8	3200	4500	0,25
62	0,42	1,41	108	0,78	3600	4800	0,45
130	0,34	1,8	196	1	2800	4000	1,22
116	0,4	1,5	174	0,8	2800	4000	1,24
116	0,4	1,5	174	0,8	2800	4000	1,24
116	0,4	1,5	174	0,8	2800	4000	1,26
133	0,38	1,6	167	0,9	2600	3800	1,44
209	0,34	1,78	279	0,98	3100	4100	1,91
189	0,34	1,8	248	1	2600	3800	2,03
92	0,44	1,4	138	0,7	2800	4000	0,9
189	0,34	1,8	248	1	2600	3800	1,92
113	0,4	1,5	172	0,8	2800	4000	1,2
106	0,49	1,23	168	0,68	3200	4200	0,88
166	0,36	1,67	249	0,9	3000	4000	1,41
219	0,48	1,2	296	0,7	2400	3400	2,91
161	0,36	1,7	226	0,9	2400	3600	1,64
161	0,36	1,7	226	0,9	2400	3400	2,68
191	0,4	1,49	292	0,82	2600	3400	2,47
213	0,41	1,5	307	0,8	2200	3200	3,31
167	0,4	1,48	262	0,7	2600	3500	1,9
184	0,4	1,5	239	0,8	2200	3200	2,35
321	0,36	1,66	463	0,91	2500	3400	4,15
294	0,33	1,84	417	1,01	2400	3200	3,62



**Tapered roller bearings, single row**  
inch dimensions

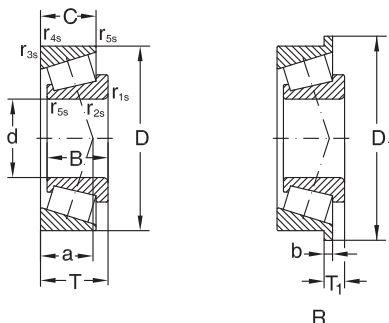

Dimensions									Designation
d	D	B	C	T / T <sub>1</sub>	r <sub>1s,2s</sub> min.	r <sub>3s,4s</sub> min.	D <sub>1</sub>	a	
mm									
<b>76,200</b>	161,925	55,100	42,862	53,975	3,5	3,3		40	<b>6576/6535</b>
<b>77,788</b>	120,000	23,012	16,000	23,000	3,5	2,3		24	<b>34306/34472 X</b>
<b>80,962</b>	150,089	46,672	36,512	44,450	5	3,3		32,3	<b>740/742</b>
<b>82,550</b>	133,350	33,338	26,195	33,338	3,5	3,3		29,5	<b>47686/47620</b>
	139,992	36,098	28,575	36,512	3,5	3,3		31	<b>580/572</b>
	146,050	41,275	31,750	41,275	3,5	3,3		34	<b>663/653</b>
	152,400	41,275	31,750	41,275	3,5	3,3		33,7	<b>663/652</b>
	161,925	48,260	38,100	47,625	3,5	3,3		35	<b>757/752</b>
<b>85,025</b>	150,089	46,672	36,512	44,450	3,5	3,3		32,3	<b>749/742</b>
<b>85,725</b>	133,350	29,769	25,400	33,338	3,3	3,3		31	<b>497/492 W</b>
	146,050	41,275	31,750	41,275	6,4	3,3		34	<b>665 A/653</b>
	152,400	36,322	30,162	39,688	3,5	3,3			<b>596/592 A</b>
<b>88,900</b>	152,400	36,322	30,162	39,688	3,5	3,3		36,8	<b>593/592 A</b>
	152,400	39,688	30,162	39,688	6,4	3,3		34	<b>HM518445/HM518410</b>
	161,925	48,260	38,100	47,625	3,5	3,3		34,9	<b>759/752</b>
	190,500	57,531	46,038	57,150	8	3,3		41	<b>HH221434/HH221410</b>
<b>89,975</b>	146,975	40,000	32,500	40,000	7	3,5		31	<b>HM218248/HM218210</b>
<b>92,075</b>	152,400	36,322	30,162	39,688	6,4	3,3		35	<b>598 A/592 A</b>
	171,450	48,260	38,100	47,625	3,5	3,3		37	<b>77362/77675</b>
<b>95,250</b>	148,430	28,971	21,433	28,575	3	3		33	<b>42375/42584</b>
	152,400	36,322	30,162	15,875	3,5		158,648	35	<b>594/592 R</b>
	152,400	36,322	30,162	39,688	3,5	3,3		37	<b>594/592 A</b>
	168,275	41,275	30,162	41,275	3,5	3,3		38,5	<b>683/672</b>
<b>96,838</b>	149,225	28,971	24,608	12,700	3,5		154,681	34	<b>42381/42587 R</b>
<b>100,012</b>	157,162	36,116	26,195	36,512	3,5	3,3		36	<b>52393/52618</b>
<b>101,600</b>	180,975	48,006	38,100	17,462	3,5		188,798	40	<b>780/772 R</b>
	212,725	66,675	53,975	66,675	7	3,3		48	<b>HH224335/HH224310</b>
<b>114,300</b>	177,800	41,275	30,162	41,275	3,5	3,3		43	<b>64450/64700</b>
	190,500	49,212	34,925	47,625	3,6	3,3			<b>71450/71750</b>
<b>117,475</b>	180,975	31,750	25,400	34,925	3,5	3,3		39,6	<b>68462/68712</b>
<b>120,650</b>	174,625	36,512	27,783	35,720	3,5	1,5			<b>M224749/M224710</b>
	206,375	47,625	34,925	47,625	3,5	3,5			<b>795/792</b>
<b>127,000</b>	215,900	47,625	34,925	47,625	3,5	3,3		49,9	<b>74500/74850</b>
<b>130,000</b>	234,950	63,500	49,212	63,500	6	3,3			<b>95512/95925</b>
<b>133,350</b>	215,900	47,625	34,925	20,638	3,5		223,733		<b>74525/74850 R</b>
<b>136,525</b>	215,900	47,625	34,925	20,638	3,5		223,733		<b>74537/74850 R</b>
<b>139,700</b>	215,900	47,625	34,925	47,625	3,5	3,3			<b>74550/74850</b>
	215,900	47,625	34,925	20,638	3,5		223,733		<b>74550/74850 R</b>



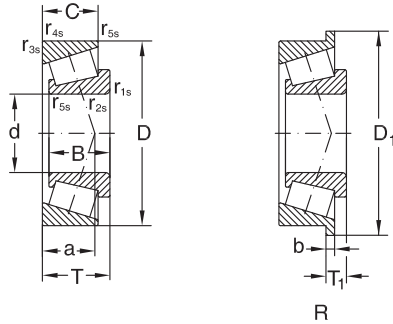

Basic radial load. Factors					Speed limit		Mass
dyn. $C_r$	e	Y	stat $C_{0r}$	$Y_0$	grease	oil	
kN	-	-	kN	-	min <sup>-1</sup>		Kg
327	0,4	1,5	448	0,8	2000	3000	5,37
84,91	0,45	1,3	117	0,7	2400	3600	0,836
294	0,33	1,84	417	1,01	2400	3200	3,39
167	0,4	1,48	262	0,7	2400	3400	1,69
168	0,4	1,5	247	0,8	2200	3200	2,13
201	0,41	1,5	286	0,8	2200	3000	3,73
229	0,41	1,47	335	0,81	2500	3300	3,12
272	0,34	1,8	358	1	2000	2800	4,7
294	0,33	1,84	417	1,01	2400	3300	3,21
135	0,45	1,3	203	0,7	2200	3200	1,34
213	0,41	1,5	307	0,8	2200	3000	2,6
200	0,44	1,36	319	0,75	2300	3100	2,86
200	0,44	1,36	319	0,75	2300	3100	2,73
235	0,4	1,5	338	0,8	2000	3000	2,8
303	0,34	1,76	441	0,97	2300	3100	4,06
395	0,34	1,8	526	1	1800	2600	8,85
220	0,33	1,8	386	1	2000	3000	2,59
174	0,44	1,4	268	0,7	2000	2800	2,59
305	0,37	1,6	416	0,9	1900	2600	4,79
136	0,49	1,2	416	0,7	2000	2800	1,72
204	0,44	1,4	313	0,7	2000	2800	2,64
200	0,44	1,36	319	0,75	2000	2800	2,47
245	0,47	1,28	386	0,7	2100	2800	3,68
136	0,49	1,2	210	0,7	2000	2800	1,74
142	0,47	1,3	195	0,7	1900	2800	2,47
321	0,39	1,6	462	0,9	1700	2400	5,5
557	0,33	1,8	783	1	1600	2200	11,1
254	0,52	1,15	419	0,6	2600	3800	3,45
337	0,42	1,44	543	0,79	1800	2500	5,14
181	0,47	1,28	271	0,7	2100	2800	2,74
220	0,33	1,8	375	1	1700	2400	2,7
308	0,49	1,2	523	0,7	1400	2000	6,97
507	0,36	1,6	784	0,9	1300	1900	11,3
313	0,49	1,2	528	0,7	1400	2000	6,78
313	0,49	1,2	528	0,7	1400	2000	6,53
310	0,49	1,2	531	0,7	1400	2000	6,08
310	0,49	1,2	531	0,7	1400	2000	6,17



**Tapered roller bearings, single row**  
inch dimensions

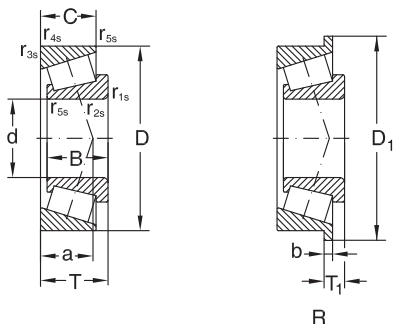

R

Dimensions									Designation
d	D	B	C	T / T <sub>1</sub>	r <sub>1s,2s</sub> min.	r <sub>3s,4s</sub> min.	D <sub>1</sub>	a	
mm									
<b>158,750</b>	225,425	39,688	33,338	41,275	3,5	3,3			<b>46780/46720</b>
	225,425	39,688	33,338	13,495	3,5		230,881		<b>46780/46720 R</b>
<b>180,000</b>	250,000	45,000	37,000	47,000	3	2,5			<b>JM736149/JM36110</b>
<b>196,850</b>	254,000	27,783	21,433	28,575	1,5	1,5			<b>L540049/L540010</b>
<b>203,200</b>	261,142	27,783	21,433	28,575	1,5	1,5			<b>LL641149/LL641110</b>
<b>209,550</b>	282,575	46,038	36,512	46,038	3,5	3,3			<b>67989/67920</b>
	317,500	63,500	46,038	63,500	4,3	3,3			<b>93825/93125</b>
<b>234,950</b>	327,025	52,388	36,512	52,388	6,4	3,3			<b>8575/8520</b>
<b>241,300</b>	327,025	52,388	36,512	25,400	6,4		336,448		<b>8578/8520 R</b>

\*Special mounting chamfer.

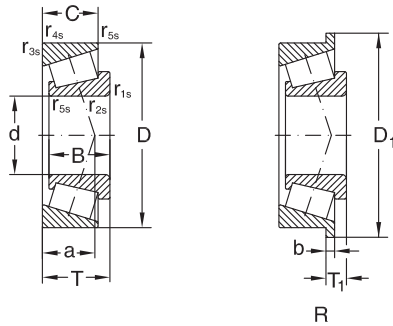

dyn. $C_r$ kN	Basic radial load. Factors				Speed limit		Mass Kg
	e	Y	stat $C_{0r}$ kN	$Y_0$	grease	oil	
					min <sup>-1</sup>		
305	0,38	1,6	541	0,9	1300	1800	5,35
305	0,38	1,6	541	0,9	1300	1800	5,4
334	0,48	1,3	703	0,7	1100	1600	7,85
170	0,39	1,5	334	0,9	1100	1600	3,32
174	0,41	1,5	353	0,8	1100	1500	3,56
331	0,51	1,2	661	0,6	1000	1400	8,84
651	0,52	1,2	1098	0,6	950	1300	18,5
468	0,41	1,5	934	0,8	850	1200	12,3
468	0,41	1,5	934	0,8	850	1200	11,9



# Spherical roller bearings

Spherical roller bearings operate in arduous conditions. The spherical rollers can be symmetrical or unsymmetrical and are self-aligning in the outer ring sphered raceway. Thus, the possible coaxiality deviations of the supporting bearings as well as shaft bending can be compensated.

Spherical roller bearings are manufactured in the following constructive versions, depending on the bearing size and series.

## MB design

These bearings have a central fixed rib and machined cages guided on the inner ring rib.

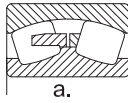

## MA design

These bearings have a central fixed rib and machined cages guided on the outer ring rib.

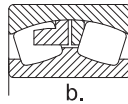

## C design

These bearings have a central guide rib floating on the inner ring, symmetrical rollers with larger dimensions so that the load carrying capacity increases. Special pressed sheet cage. Bearings of this design are of small and medium sizes.

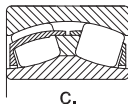

## CA design

These bearings have side shoulders and an one-piece machined brass cage. They also have symmetrical rollers with larger dimensions so that the load carrying capacity increases. This design is available for medium and large-sized bearings

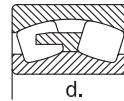

Other constructive versions are shown below:

Cylindrical bore, lubrication groove and holes in the outer ring



Tapered bore, lubrication groove and holes in the outer ring (taper 1:12, 1:30)



With adapter sleeves

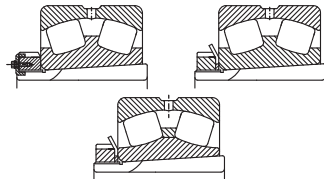

With withdrawal sleeves





### Suffixes

- C** - modified inner design, increased basic load, symmetrical rollers, pressed sheet cage.
- CA** - modified inner design, increased basic load, one-piece machined brass cage
- F2, F3**- constructive modifications
- K** - tapered bore bearings, taper 1:12
- K30** - tapered bore bearings, taper 1:30
- MA** - machined brass cage guided on the outer ring
- MB** - machined brass cage guided on the inner ring
- P** - two-piece outer ring
- W33** - lubrication groove and holes in the outer ring

### Tolerances

Spherical roller bearings with both cylindrical and tapered bore, are manufactured in normal tolerance class (see chapter Bearing tolerance, page 25).

### Radial Clearance

Spherical roller bearings are generally manufactured with normal radial clearance. At request, they can be manufactured with clearances larger than normal (C3, C4 etc.) or smaller than normal (C2).

The limit values of the radial clearance measured on unloaded bearings are in accordance with SR ISO 5753 and are given in tables 1 and 2.

### Dimensions

The main dimensions of spherical roller bearings are in accordance with ISO 15 and national standard SR 3918 respectively.

The dimensions of the adapter sleeves are in accordance with national standard SR ISO 2982-1.

The dimensions of the safety washers are in accordance with national standard SR ISO 2982-2.

**Radial clearance of spherical roller bearings with cylindrical bore**

Table 1

Bore diameter d		Radial clearance									
		C2		Normal		C3		C4		C5	
over	up to	min	max	min	max	min	max	min	max	min	max
14	18	10	20	20	35	35	45	45	60	60	75
18	24	10	20	20	35	35	45	45	60	60	75
24	30	15	25	25	40	40	55	55	75	75	95
30	40	15	30	30	45	45	60	60	80	80	100
40	50	20	35	35	55	55	75	75	100	100	125
50	65	20	40	40	65	65	90	90	120	120	150
65	80	30	50	50	80	80	110	110	145	145	180
80	100	35	60	60	100	100	135	135	180	180	225
100	120	40	75	75	120	120	160	160	210	210	260
120	140	50	95	95	145	145	190	190	240	240	300
140	160	60	110	110	170	170	220	220	280	280	350
160	180	65	120	120	180	180	240	240	310	310	390
180	200	70	130	130	200	200	260	260	340	340	430
200	225	80	140	140	220	220	290	290	380	380	470
225	250	90	150	150	240	240	320	320	420	420	520
250	280	100	170	170	260	260	350	350	460	460	570
280	315	110	190	190	280	280	370	370	500	500	630
315	355	120	200	200	310	310	410	410	550	550	690
355	400	130	220	220	340	340	450	450	600	600	750
400	450	140	240	240	370	370	500	500	660	660	820
450	500	140	260	260	410	410	550	550	720	720	900
500	560	150	280	280	440	440	600	600	780	780	1000
560	630	170	310	310	480	480	650	650	850	850	1100
630	710	190	350	350	530	530	700	700	920	920	1190
710	800	210	390	390	580	580	770	770	1010	1010	1300
800	900	230	430	430	650	650	860	860	1120	1120	1440
900	1000	260	480	480	710	710	930	930	1220	1220	1570

**Radial clearance of spherical roller bearings with tapered bore**

Table 2

Bore diameter d		Radial clearance									
		C2		Normal		C3		C4		C5	
over	up to	min	max	min	max	min	max	min	max	min	max
<b>18</b>	<b>24</b>	15	25	75	35	35	45	45	60	60	75
<b>24</b>	<b>30</b>	20	30	30	40	40	55	55	75	75	95
<b>30</b>	<b>40</b>	25	35	35	50	50	65	65	85	85	105
<b>40</b>	<b>50</b>	30	45	45	60	60	80	80	100	100	130
<b>50</b>	<b>65</b>	40	55	55	75	75	95	95	120	120	160
<b>65</b>	<b>80</b>	50	70	70	95	95	120	120	150	150	200
<b>80</b>	<b>100</b>	55	80	80	110	110	140	140	180	180	230
<b>100</b>	<b>120</b>	65	100	100	135	135	170	170	220	220	280
<b>120</b>	<b>140</b>	80	120	120	160	160	200	200	260	260	330
<b>140</b>	<b>160</b>	90	130	130	180	180	230	230	300	300	380
<b>160</b>	<b>180</b>	100	140	140	200	200	260	260	340	340	430
<b>180</b>	<b>200</b>	110	160	160	220	220	290	290	370	370	470
<b>200</b>	<b>225</b>	120	180	180	250	250	320	320	410	410	520
<b>225</b>	<b>250</b>	140	200	200	270	270	350	350	450	450	570
<b>250</b>	<b>280</b>	150	220	220	300	300	390	390	490	490	620
<b>280</b>	<b>315</b>	170	240	240	330	330	430	430	540	540	680
<b>315</b>	<b>355</b>	190	270	270	360	360	470	470	590	590	740
<b>355</b>	<b>400</b>	210	300	300	400	400	520	520	650	650	820
<b>400</b>	<b>450</b>	230	330	330	440	440	570	570	720	720	910
<b>450</b>	<b>500</b>	260	370	370	490	490	630	630	790	790	1000
<b>500</b>	<b>560</b>	290	410	410	540	540	680	680	870	870	1100
<b>560</b>	<b>630</b>	320	460	460	600	600	760	760	980	980	1230
<b>630</b>	<b>710</b>	350	510	510	670	670	850	850	1090	1090	1360
<b>710</b>	<b>800</b>	390	570	570	750	750	960	960	1220	1220	1500
<b>800</b>	<b>900</b>	440	640	640	840	840	1070	1070	1370	1370	1690
<b>900</b>	<b>1000</b>	490	710	710	930	930	1190	1190	1520	1520	1860

The dimensions of the bearings nuts are in accordance with national standard SR ISO 2982-2.

The dimensions of the withdrawal sleeves are in accordance with national standard SR ISO 2982-1 and pages 416-437.

### Misalignment

Spherical roller bearings allow angular misalignment between the outer ring and Inner ring without any influence on the bearing rating life. Under normal loads and operating conditions and when the Inner ring rotates, the values of the permissible misalignment depending on the bearing series are given in table 3.

### Cages

Small and medium size spherical roller bearing are fitted with pressed sheet or machined brass cages (Y). Bearings of normal design are fitted with

machined brass or steel cages guided on the rollers (M), inner ring (MB) or outer ring raceway (MA).

Glass fibre reinforced polyamide 6.6 cages are successfully used for small and medium size bearings if the operating temperature doesn't exceed +120°C.

Large-size bearings are fitted with machined brass cages, CA design.

Designs and some technical data are given in table 4.

Table 3	
Bearing series	Permissible angular misalignment [degrees]
213	1
222	1,5
223	2
230	1,5
231	1,5
232	2,5
239	1,5
240	2
241	2,5



Cage design and some technical data

Table 4

Cage	Design		Application	Max. value D <sub>n</sub>	
	bearing	cage		oil	grease
<b>C design</b> - Floating guiding middle collar on inner ring - Special steel sheet cage - Oversize symmetrical spherical rollers to provide for increased loading capacity - Small and middle size bearings are produced in this version			- General application design - Moderate speeds - Bearings with d<200mm	300 x 10 <sup>3</sup>	225 x 10 <sup>3</sup>
<b>MA design</b> - Machined solid brass cage guided on outer ring - Middle standing collar on inner ring - Side flanges on inner ring			- General application - Moderate and high speeds - Bearings with d>200 mm	400 x 10 <sup>3</sup>	300 x 10 <sup>3</sup>
<b>CA design</b> - One-piece solid brass cage - Side flanges on inner ring - Oversize symmetrical spherical rollers to provide with increased loading capacity - Middle and large size bearings are produced in this version			- General application - Bearings with d>200 mm	350 x 10 <sup>3</sup>	265 x 10 <sup>3</sup>
<b>MB design</b> - Middle standing collar on inner ring - Machined solid brass cage guided on collar - Side flanges on inner ring - All bearings sizes can be produced in this version			- General application - Bearings with d>40mm	350 x 10 <sup>3</sup>	265 x 10 <sup>3</sup>

**Lubrication grooves and holes**

Spherical roller bearings are provided with a lubrication groove and holes in the outer ring, excepting those of series 213. Designation suffix W33 is used to identify this feature on bearings. The dimensions of the groove, bore diameter and their number depending on the dimension series are given in table 5.

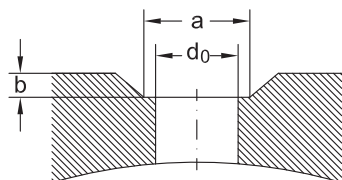

**Axial load for bearings mounted on adapter sleeves**

If the spherical roller bearings are mounted on a smooth shaft using an adapter sleeve, without side support, the axial load carrying capacity depends on the friction between shaft and sleeve.

Considering that the mounting is correctly done, the permissible axial load can be accurately enough determined using the following equation

$$F_{a \max} = 3 * B * d, \text{ KN}$$

where:

- F<sub>a max</sub> - maximum permissible axial load, KN;
- B - bearing width, mm;
- d - bearing bore diameter, mm.



**Dimensions of lubrication grooves and holes**

Table 5

Series 23900				Series 23000				Series 24000			
Outer diameter range	Dimensions			Outer diameter range	Dimensions			Outer diameter range	Dimensions		
	d0	a	b		d0	a	b		d0	a	b
mm				mm				mm			
250 ... 380	4,5	7,2	1,5	170 ... 225	4,5	7,2	1,5	... 200	4,5	7,2	1,5
380 ... 440	4,5	7,2	2	225 ... 280	6	9,6	2	200 ... 240	6	9,6	2
440 ... 520	6	9,6	3	280 ... 310	7,5	12,1	2,5	240 ... 280	7,5	12,1	2,5
520 ... 560	7,5	12,1	3	310 ... 480	9	14,5	3	280 ... 520	9	14,5	3
560 ... 670	9	14,5	3	480 ... 980	12	19,7	3	520 ... 600	9	14,5	3
670 ... 1000	12	19,7	3,5					600 ... 980	12	19,7	3

Series 23100				Series 24100				Series 22200			
Outer diameter range	Dimensions			Outer diameter range	Dimensions			Outer diameter range	Dimensions		
	d0	a	b		d0	a	b		d0	a	b
mm				mm				mm			
250 ... 380	4,5	7,2	1,5	170 ... 225	4,5	7,2	1,5	... 200	4,5	7,2	1,5
380 ... 440	4,5	7,2	2	225 ... 280	6	9,6	2	200 ... 240	6	9,6	2
440 ... 520	6	9,6	3	280 ... 310	7,5	12,1	2,5	240 ... 280	7,5	12,1	2,5
520 ... 560	7,5	12,1	3	310 ... 480	9	14,5	3	280 ... 520	9	14,5	3
560 ... 670	9	14,5	3	480 ... 980	12	19,7	3	520 ... 600	9	14,5	3
670 ... 1000	12	19,7	3,5	480 ... 980	12	19,7	3	520 ... 600	9	14,5	3
								600 ... 980	12	19,7	3

Series 23200				Series 22300				Series 21300			
Outer diameter range	Dimensions			Outer diameter range	Dimensions			Outer diameter range	Dimensions		
	d0	a	b		d0	a	b		d0	a	b
mm				mm				mm			
250 ... 380	4,5	7,2	1,5	170 ... 225	4,5	7,2	1,5	... 200	4,5	7,2	1,5
380 ... 440	4,5	7,2	2	225 ... 280	6	9,6	2	200 ... 240	6	9,6	2
440 ... 520	6	9,6	3	280 ... 310	7,5	12,1	2,5	240 ... 280	7,5	12,1	2,5
520 ... 560	7,5	12,1	3	310 ... 480	9	14,5	3	280 ... 520	9	14,5	3
560 ... 670	9	14,5	3	480 ... 980	12	19,7	3	520 ... 600	9	14,5	3
560 ... 670	9	14,5	3	480 ... 980	12	19,7	3	520 ... 600	9	14,5	3

**Number of lubrication holes - all series**

<b>Bore diameter range [mm]</b>	50 ... 260	260 ... 460	460 ... 950
<b>Number of lubrication holes</b>	3	4	6



### Equivalent dynamic radial load

$$P_r = F_r + Y_1 F_a, \text{ kN, for } F_a/F_r < e$$

$$P_r = 67 F_r + Y_2 F_a, \text{ kN, for } F_a/F_r > e$$

The values of the factors depending on the bearing type can be found in bearing tables.

### Equivalent static radial load

$$P_{0r} = F_r + Y_0 * F_a, \text{ KN}$$

The value of the factor Y0 depending on the bearing type can be found in bearing tables.

### Abutment dimensions

For a proper location of bearing rings on the shaft and housing shoulder respectively, shaft (housing) maximum connection radius  $r_{u \text{ max}}$  should be less than bearing minimum mounting chamfer  $r_{s \text{ min}}$ .

Shoulder height should also be properly sized in case of bearing maximum mounting chamfer.

The values of the connection radii and support shoulder height are given in table 6. The mounting dimensions for bearings with withdrawal sleeves are given in table 6.

Abutment dimensions of spherical roller bearings

Table 6

rs min	ru max	hu max	
		Bearing series	
		230 239 240	231, 213, 241, 223, 222, 233, 232
mm			
1	1	2,3	2,8
1,1	1	3	3,5
1,5	1,5	3,5	4,5
2	2	4,4	5,5
2,1	2,1	5,1	6
3	2,5	6,2	7
4	3	7,3	8,5
5	4	9	10
6	5	11,5	13
7,5	6	14	16
9,5	8	17	20

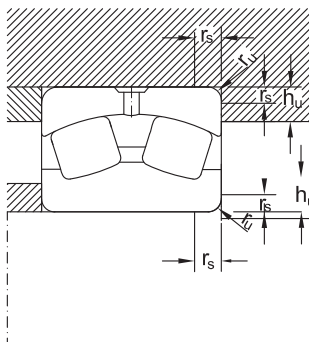
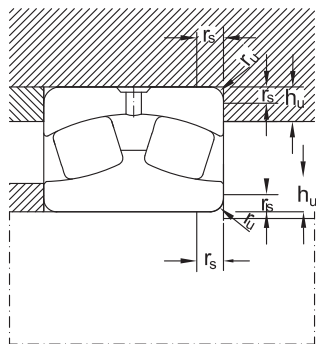

# URB





### Spherical Roller Bearings

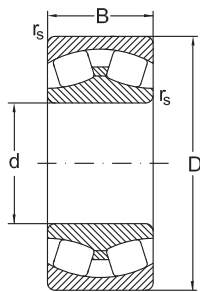

C

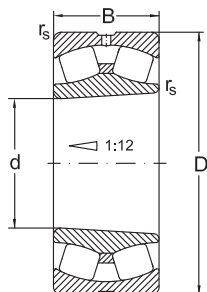

CKW33

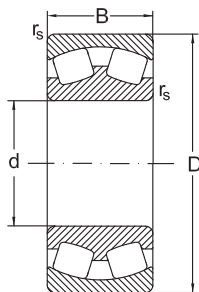

MB

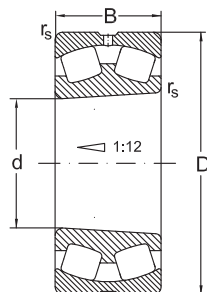

MBKW33

Dimensions				Basic radial load. Factors				
d	D	B	r <sub>s</sub> min.	dyn. C <sub>r</sub>	e	y <sub>1</sub>	y <sub>2</sub>	stat. C <sub>0r</sub>
mm				kN				kN
25	52	18	1	43	0,35	1,8	2,9	46
	52	18	1	43	0,35	1,8	2,9	46
30	62	20	1	59	0,33	2	3,1	62
	62	20	1	59	0,33	2	3,1	62
35	72	23	1,1	81	0,32	2,1	3,1	88
	72	23	1,1	81	0,32	2,1	3,1	88
	80	21	1,5	66	0,28	2,4	3,6	65
	80	21	1,5	66	0,28	2,4	3,6	65
40	80	23	1,1	88	0,31	2,2	3,2	98
	80	23	1,1	88	0,31	2,2	3,2	98
	80	23	1,1	88	0,31	2,2	3,2	98
	80	23	1,1	78	0,31	2,2	3,2	87
	80	23	1,1	78	0,31	2,2	3,2	87
	80	23	1,1	78	0,31	2,2	3,2	87
	80	23	1,1	78	0,31	2,2	3,2	87
	80	23	1,1	78	0,31	2,2	3,2	87
	80	23	1,1	78	0,31	2,2	3,2	87
	90	23	1,5	99	0,26	2,6	3,9	120
	90	23	1,5	99	0,26	2,6	3,9	120
	90	23	1,5	99	0,26	2,6	3,9	120
	90	33	1,5	140	0,4	1,6	2,5	145
	90	33	1,5	140	0,4	1,6	2,5	145
	90	33	1,5	140	0,4	2,6	2,5	145
90	33	1,5	140	0,4	2,5	2,5	145	
90	33	1,5	140	0,4	1,6	2,5	145	
90	33	1,5	140	0,4	1,6	2,5	145	

## Spherical Roller Bearings

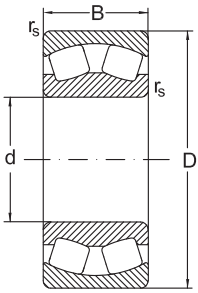

CA

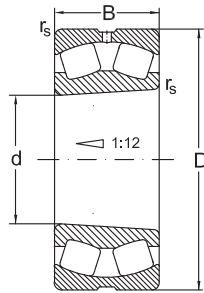

CAKW33

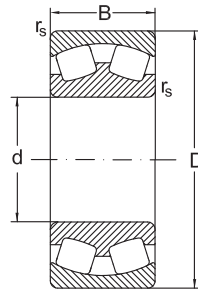

MA

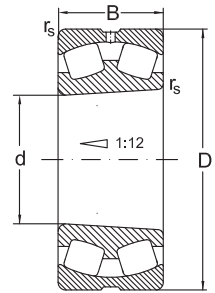

MAKW33

d	$y_0$	Speed limit		Designation	Mass
		grease	oil	Bearing	
mm		min <sup>-1</sup>			kg
25	1,9	7500	10000	<b>22205 CW33</b>	0,182
	1,9	7500	10000	<b>22205 CKW33</b>	0,177
30	2	6300	8500	<b>22206 CW33</b>	0,287
	2	6300	8500	<b>22206 CKW33</b>	0,281
35	2	5300	7000	<b>22207 CW33</b>	0,438
	2	5300	7000	<b>22207 CKW33</b>	0,428
	2,4	5000	6400	<b>21307 MBKW33</b>	0,55
	2,4	5000	6400	<b>21307 MBW33</b>	0,56
40	2,1	4800	6300	<b>22208 C</b>	0,54
	2,1	4800	6300	<b>22208 CK</b>	0,54
	2,1	4800	6300	<b>22208 CKW33</b>	0,52
	2,1	4400	5800	<b>22208 MAC4F80W33</b>	0,654
	2,1	4400	5800	<b>22208 MB</b>	0,57
	2,1	4400	5800	<b>22208 MBK</b>	0,57
	2,1	4400	5800	<b>22208 MBKW33</b>	0,56
	2,1	4400	5800	<b>22208 MBW33</b>	0,56
	2,6	4500	6000	<b>21308 C</b>	0,71
	2,6	4500	6000	<b>21308 CK</b>	0,7
	2,6	4500	6000	<b>21308 CKW33</b>	0,7
	1,6	4300	5600	<b>22308 C</b>	0,97
	1,6	4300	5600	<b>22308 CK</b>	0,95
	1,6	4300	5600	<b>22308 CKW33</b>	0,93
1,6	4300	5600	<b>22308 CW33</b>	0,96	
1,6	4300	5600	<b>22308 CY</b>	0,98	
1,6	4300	5600	<b>22308 CYK</b>	0,95	



### Spherical Roller Bearings

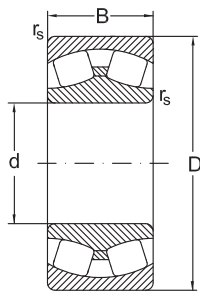

C

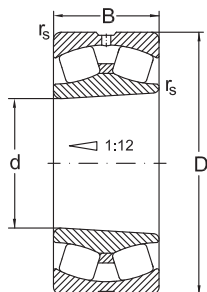

CKW33

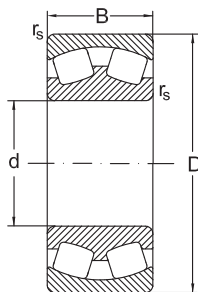

MB

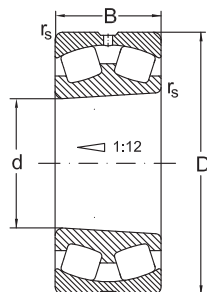

MBKW33

Dimensions				Basic radial load. Factors				
d	D	B	r <sub>s</sub> min.	dyn. C <sub>r</sub>	e	y <sub>1</sub>	y <sub>2</sub>	stat. C <sub>0r</sub>
mm				kN				kN
40	90	33	1,5	140	0,4	1,6	2,5	145
	90	33	1,5	140	0,4	1,6	2,5	145
	90	33	1,5	125	0,4	1,7	2,5	135
	90	33	1,5	125	0,4	1,7	2,5	135
	90	33	1,5	125	0,4	1,7	2,5	135
	90	33	1,5	125	0,4	1,7	2,5	135
	90	33	1,5	125	0,4	1,7	2,5	135
45	85	23	1,1	93	0,26	2,6	3,4	105
	85	23	1,1	93	0,26	2,6	3,4	105
	85	23	1,1	93	0,26	2,6	3,4	105
	85	23	1,1	93	0,26	2,6	3,4	105
	85	23	1,1	77	0,28	2,4	3,5	87,5
	85	23	1,1	77	0,28	2,4	3,5	87,5
	85	23	1,1	77	0,28	2,4	3,5	87,5
	85	23	1,1	77	0,28	2,4	3,5	87,5
	100	25	1,5	120	0,26	2,6	3,9	135
	100	25	1,5	120	0,26	2,6	3,9	135
	100	25	1,5	120	0,26	2,6	3,9	135
	100	25	1,5	105	0,28	2,4	3,6	107
	100	36	1,5	165	0,35	1,9	2,9	190
	100	36	1,5	165	0,35	1,9	2,9	190
	100	36	1,5	165	0,35	1,9	2,9	190
	100	36	1,5	165	0,35	1,9	2,9	190
	100	36	1,5	150	0,4	1,7	2,5	175
100	36	1,5	150	0,4	1,7	2,5	175	

## Spherical Roller Bearings

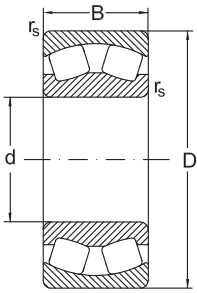

CA

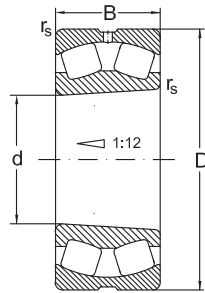

CAKW33

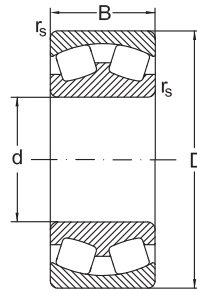

MA

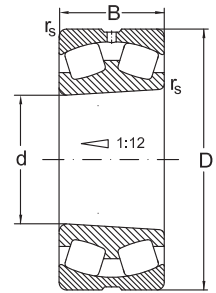

MAKW33

d	$y_0$	Speed limit		Designation	Mass
		grease	oil		
mm		min <sup>-1</sup>		Bearing	kg
40	1,6	4300	5600	<b>22308 CYKW33</b>	0,94
	1,6	4300	5600	<b>22308 CYW33</b>	0,972
	1,6	3800	5000	<b>22308 MAK4F80W33</b>	1,42
	1,6	3800	5000	<b>22308 MBK</b>	1
	1,6	3800	5000	<b>22308 MBKW33</b>	0,99
	1,6	3800	5000	<b>22308 MB</b>	1,05
	1,6	3800	5000	<b>22308 MBW33</b>	1,01
45	2,5	4500	6000	<b>22209 C</b>	0,71
	2,5	4500	6000	<b>22209 CK</b>	0,7
	2,5	4500	6000	<b>22209 CKW33</b>	0,66
	2,5	4500	6000	<b>22209 CW33</b>	0,68
	2,3	4100	5500	<b>22209 MBK</b>	0,73
	2,3	4100	5500	<b>22209 MBKW33</b>	0,71
	2,3	4100	5500	<b>22209 MB</b>	0,77
	2,3	4100	5500	<b>22209 MBW33</b>	0,75
	2,6	4000	5300	<b>21309 C</b>	0,94
	2,6	4000	5300	<b>21309 CK</b>	0,93
	2,6	4000	5300	<b>21309 CKW33</b>	0,93
	2,3	3600	4800	<b>21309 MB</b>	0,94
	1,9	3800	5000	<b>22309 C</b>	1,33
	1,9	3800	5000	<b>22309 CK</b>	1,3
	1,9	3800	5000	<b>22309 CKW33</b>	1,3
	1,9	3800	5000	<b>22309 CW33</b>	1,33
	1,6	3400	4500	<b>22309 MBK</b>	1,37
	1,6	3400	4500	<b>22309 MBKW33</b>	1,32



### Spherical Roller Bearings

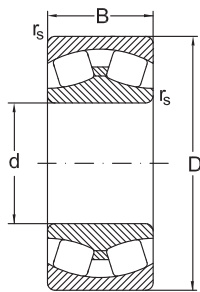

C

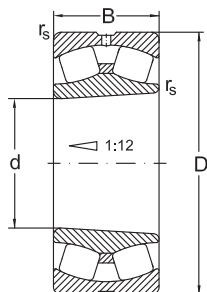

CKW33

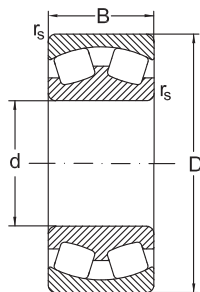

MB

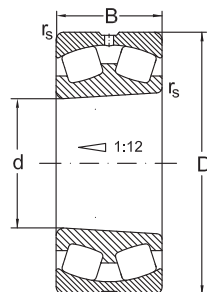

MBKW33

Dimensions				Basic radial load. Factors				
d	D	B	r <sub>s</sub> min.	dyn. C <sub>r</sub>	e	y <sub>1</sub>	y <sub>2</sub>	stat. C <sub>0r</sub>
mm				kN				kN
45	100	36	1,5	150	0,4	1,7	2,5	175
	100	36	1,5	150	0,4	1,7	2,5	175
50	90	23	1,1	100	0,24	2,9	4,2	120
	90	23	1,1	100	0,24	2,9	4,2	120
	90	23	1,1	100	0,24	2,9	4,2	120
	90	23	1,1	100	0,24	2,9	4,2	120
	90	23	1,1	78	0,26	2,6	3,8	91,3
	90	23	1,1	78	0,26	2,6	3,8	91,3
	90	23	1,1	78	0,26	2,6	3,8	91,3
	90	23	1,1	78	0,26	2,6	3,8	91,3
	110	27	2	120	0,24	2,8	4,1	130
	110	27	2	120	0,24	2,8	4,1	130
	110	27	2	120	0,24	2,8	4,1	130
	110	40	2	190	0,38	1,8	2,7	220
	110	40	2	190	0,38	1,8	2,7	220
	110	40	2	190	0,38	1,8	2,7	220
	110	40	2	190	0,38	1,8	2,7	220
	110	40	2	190	0,38	1,8	2,7	220
	110	40	2	190	0,38	1,8	2,7	220
	110	40	2	177	0,4	1,7	2,5	202
	110	40	2	177	0,4	1,7	2,5	202
	110	40	2	177	0,4	1,7	2,5	202
110	40	2	177	0,4	1,7	2,5	202	



## Spherical Roller Bearings

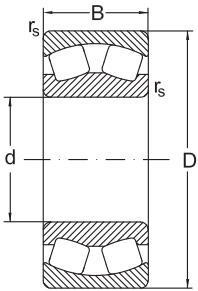

CA

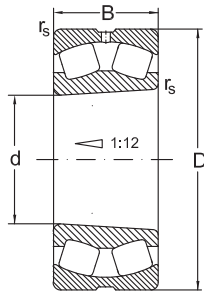

CAKW33

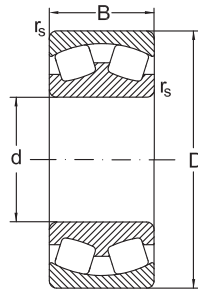

MA

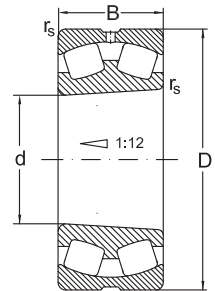

MAKW33

d	$y_0$	Speed limit		Designation	Mass
		grease	oil		
mm		min <sup>-1</sup>		Bearing	kg
45	1,6	3400	4500	<b>22309 MB</b>	1,37
	1,6	3400	4500	<b>22309 MBW33</b>	1,35
50	2,7	4000	5300	<b>22210 C</b>	0,74
	2,7	4000	5300	<b>22210 CK</b>	0,7
	2,7	4000	5300	<b>22210 CKW33</b>	0,69
	2,7	4000	5300	<b>22210 CW33</b>	0,72
	2,5	3600	4800	<b>22210 MBK</b>	0,76
	2,5	3600	4800	<b>22210 MBKW33</b>	0,75
	2,5	3600	4800	<b>22210 MB</b>	0,77
	2,5	3600	4800	<b>22210 MBW33</b>	0,76
	2,7	3600	4800	<b>21310 C</b>	1,25
	2,7	3600	4800	<b>21310 CK</b>	1,2
	2,7	3600	4800	<b>21310 CKW33</b>	1,2
	1,7	3400	4500	<b>22310 C</b>	1,81
	1,7	3400	4500	<b>22310 CK</b>	1,77
	1,7	3400	4500	<b>22310 CKW33</b>	1,76
	1,7	3400	4500	<b>22310 CW33</b>	1,8
	1,7	3400	4500	<b>22310 CY</b>	1,82
	1,7	3400	4500	<b>22310 CYKW33</b>	1,77
	1,7	3400	4500	<b>22310 CYW33</b>	1,81
1,6	3000	4000	<b>22310 MBK</b>	1,84	
1,6	3000	4000	<b>22310 MBKW33</b>	1,83	
1,6	3000	4000	<b>22310 MAC4F80W33</b>	1,83	
1,6	3000	4000	<b>22310 MB</b>	1,85	



### Spherical Roller Bearings

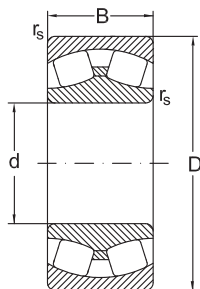

C

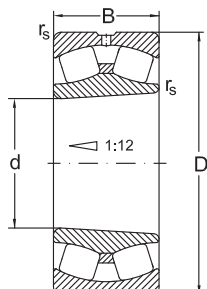

CKW33

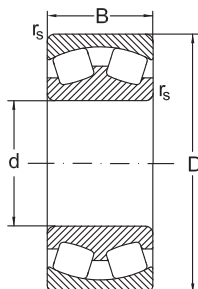

MB

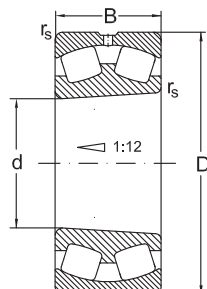

MBKW33

Dimensions				Basic radial load. Factors					
d	D	B	r <sub>s</sub> min.	dyn. C <sub>r</sub>	e	y <sub>1</sub>	y <sub>2</sub>	stat. C <sub>0r</sub>	
mm				kN				kN	
<b>50</b>	110	40	2	177	0,4	1,7	2,5	202	
	<b>55</b>	100	25	1,5	120	0,27	2,7	4,1	140
		100	25	1,5	120	0,27	2,7	4,1	140
		100	25	1,5	120	0,27	2,7	4,1	140
		100	25	1,5	120	0,27	2,7	4,1	140
		100	25	1,5	94	0,26	2,6	3,9	107
		100	25	1,5	94	0,26	2,6	3,9	107
		100	25	1,5	94	0,26	2,6	3,9	107
		100	25	1,5	94	0,26	2,6	3,9	107
		120	29	2	135	0,24	2,8	4,1	155
120		29	2	135	0,24	2,8	4,1	155	
<b>55</b>	120	43	2	230	0,4	1,7	2,5	265	
	120	43	2	230	0,4	1,7	2,5	265	
	120	43	2	230	0,4	1,7	2,5	265	
	120	43	2	230	0,4	1,7	2,5	265	
	120	43	2	230	0,4	1,7	2,5	265	
	120	43	2	230	0,4	1,7	2,5	265	
	120	43	2	230	0,4	1,7	2,5	265	
	120	43	2	230	0,4	1,7	2,5	265	
	120	43	2	230	0,4	1,7	2,5	265	
	120	43	2	230	0,4	1,7	2,5	265	
	120	43	2	220	0,4	1,7	2,5	255	
	120	43	2	220	0,4	1,7	2,5	255	
	120	43	2	220	0,4	1,7	2,5	255	
	120	43	2	220	0,4	1,7	2,5	255	

## Spherical Roller Bearings

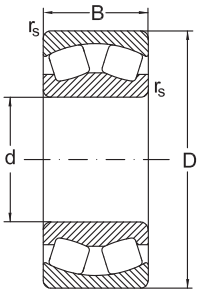

CA

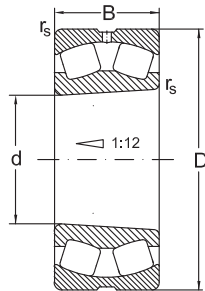

CAKW33

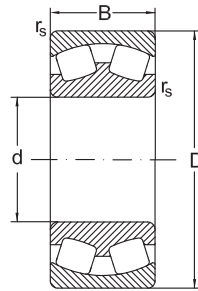

MA

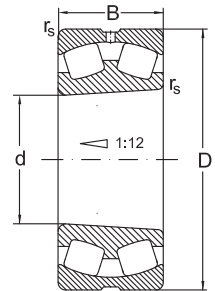

MAKW33

d	$y_0$	Speed limit		Designation	Mass
		grease	oil		
mm		$\text{min}^{-1}$		Bearing	kg
50	1,6	3000	4000	<b>22310 MBW33</b>	1,84
	2,7	3800	5000	<b>22211 C</b>	0,93
	2,7	3800	5000	<b>22211 CK</b>	0,9
	2,7	3800	5000	<b>22211 CKW33</b>	0,87
	2,7	3800	5000	<b>22211 CW33</b>	0,89
	2,5	3600	4600	<b>22211 MBK</b>	0,89
	2,5	3600	4600	<b>22211 MBKW33</b>	0,88
	2,5	3600	4600	<b>22211 MB</b>	0,91
	2,5	3600	4600	<b>22211 MBW33</b>	0,89
	2,7	3200	4300	<b>21311 C</b>	1,65
55	2,7	3200	4300	<b>21311 CK</b>	1,6
	1,6	3000	4000	<b>22311 C</b>	2,32
	1,6	3000	4000	<b>22311 CK</b>	2,27
	1,6	3000	4000	<b>22311 CKW33</b>	2,25
	1,6	3000	4000	<b>22311 CW33</b>	2,32
	1,6	3000	4000	<b>22311 CY</b>	2,34
	1,6	3000	4000	<b>22311 CYK</b>	2,28
	1,6	3000	4000	<b>22311 CYKW33</b>	2,26
	1,6	3000	4000	<b>22311 CYW33</b>	2,32
	1,6	2800	3600	<b>22311 MBK</b>	2,1
	1,6	2800	3600	<b>22311 MAKW33</b>	2,44
	1,6	2800	3600	<b>22311 MA</b>	2,49
	1,6	2800	3600	<b>22311 MAC4F80W33</b>	2,42
	1,6	2800	3600	<b>22311 MAC4W502</b>	2,44
	1,6	2800	3600	<b>22311 MAW502</b>	2,44



### Spherical Roller Bearings

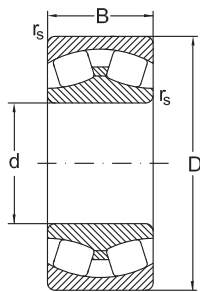

C

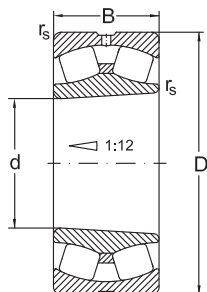

CKW33

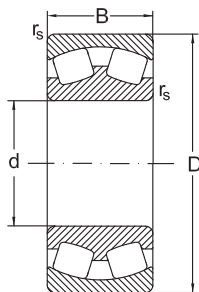

MB

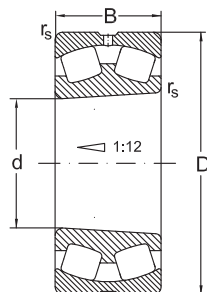

MBKW33

Dimensions				Basic radial load. Factors				
d	D	B	r <sub>s</sub> min.	dyn. C <sub>r</sub>	e	y <sub>1</sub>	y <sub>2</sub>	stat. C <sub>0r</sub>
mm				kN				kN
55	120	43	2	220	0,4	1,7	2,5	255
	120	43	2	220	0,4	1,7	2,5	255
60	110	28	1,5	145	0,27	2,7	4	175
	110	28	1,5	145	0,27	2,7	4	175
	110	28	1,5	145	0,27	2,7	4	175
	110	28	1,5	117,8	0,27	2,6	3,8	140,3
	110	28	1,5	117,8	0,27	2,6	3,8	140,3
	110	28	1,5	117,8	0,27	2,6	3,8	140,3
	110	28	1,5	117,8	0,27	2,6	3,8	140,3
	130	31	2,1	150	0,24	2,9	4,3	180
	130	31	2,1	150	0,24	2,9	4,3	180
	130	31	2,1	151	0,24	2,9	4,3	152
	130	46	2,1	270	0,4	1,7	2,5	320
	130	46	2,1	270	0,4	1,7	2,5	320
	130	46	2,1	270	0,4	1,7	2,5	320
	130	46	2,1	270	0,4	1,7	2,5	320
	130	46	2,1	270	0,4	1,7	2,5	320
	130	46	2,1	270	0,4	1,7	2,5	320
	130	46	2,1	270	0,4	1,7	2,5	320
	130	46	2,1	260	0,4	1,7	2,5	310
	130	46	2,1	260	0,4	1,7	2,5	310
	130	46	2,1	260	0,4	1,7	2,5	310
130	46	2,1	260	0,4	1,7	2,5	310	



### Spherical Roller Bearings

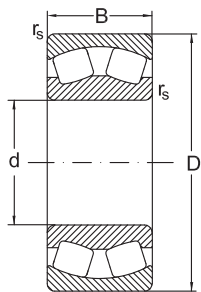

CA

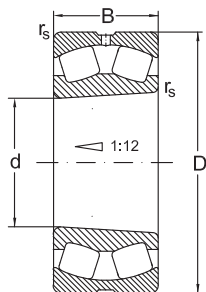

CAKW33

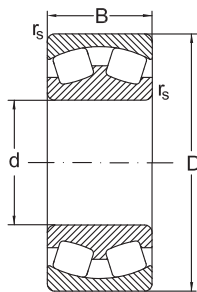

MA

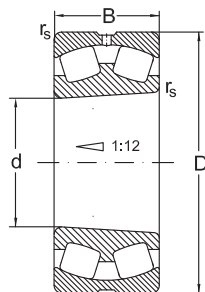

MAKW33

d	y <sub>0</sub>	Speed limit		Designation	Mass
		grease	oil	Bearing	
mm		min <sup>-1</sup>			kg
55	1,6	2800	3600	<b>22311 MB</b>	2,43
	1,6	2800	3600	<b>22311 MBW33</b>	2,42
60	2,7	3400	4500	<b>22212 C</b>	1,32
	2,7	3400	4500	<b>22212 CK</b>	1,29
	2,7	3400	4500	<b>22212 CKW33</b>	1,25
	2,5	3200	4100	<b>22212 MBK</b>	1,19
	2,5	3200	4100	<b>22212 MBKW33</b>	1,17
	2,5	3200	4100	<b>22212 MB</b>	1,22
	2,5	3200	4100	<b>22212 MBW33</b>	1,2
	2,8	3000	4000	<b>21312 C</b>	1,95
	2,8	3000	4000	<b>21312 CK</b>	1,9
	2,8	2800	3800	<b>21312 MBK</b>	2,13
	1,7	2800	3800	<b>22312 C</b>	2,91
	1,7	2800	3800	<b>22312 CK</b>	2,84
	1,7	2800	3800	<b>22312 CKW33</b>	2,8
	1,7	2800	3800	<b>22312 CW33</b>	2,87
	1,7	2800	3800	<b>22312 CY</b>	2,93
	1,7	2800	3800	<b>22312 CYK</b>	2,86
	1,7	2800	3800	<b>22312 CYKW33</b>	2,82
	1,7	2800	3800	<b>22312 CYW33</b>	2,89
1,7	2600	3400	<b>22312 MBK</b>	3,04	
1,7	2600	3400	<b>22312 MBKW33</b>	3	
1,7	2600	3400	<b>22312 MAC4F80W33</b>	3,07	
1,7	2600	3400	<b>22312 MB</b>	3,04	
1,7	2600	3400	<b>22312 MBW33</b>	3	



## Spherical Roller Bearings

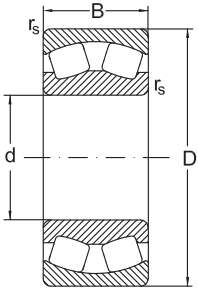

CA

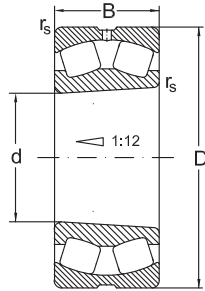

CAKW33

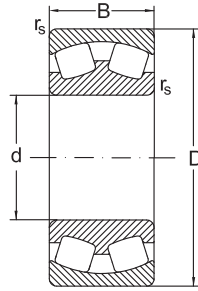

MA

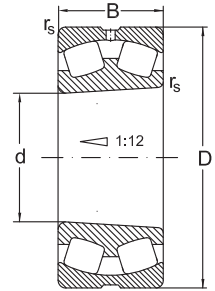

MAKW33

d	$y_0$	Speed limit		Designation	Mass
		grease	oil		
mm		min <sup>-1</sup>		Bearing	kg
65	2,4	3000	4000	<b>22213 C</b>	1,73
	2,4	3000	4000	<b>22213 CK</b>	1,71
	2,4	3000	4000	<b>22213 CKW33</b>	1,65
	2,4	3000	4000	<b>22213 CW33</b>	1,68
	2,4	2800	3600	<b>22213 MBK</b>	1,59
	2,4	2800	3600	<b>22213 MBKW33</b>	1,57
	2,4	2800	3600	<b>22213 MB</b>	1,62
	2,4	2800	3600	<b>22213 MBW33</b>	1,6
	2,8	2800	3800	<b>21313 C</b>	2,47
	2,8	2800	3800	<b>21313 CK</b>	2,43
	1,7	2800	3600	<b>22313 C</b>	3,57
	1,7	2800	3600	<b>22313 CK</b>	3,49
	1,7	2800	3600	<b>22313 CKW33</b>	3,44
	1,7	2800	3600	<b>22313 CW33</b>	3,51
	1,7	2800	3600	<b>22313 CY</b>	3,54
	1,7	2800	3600	<b>22313 CYK</b>	3,44
	1,7	2800	3600	<b>22313 CYKW33</b>	3,43
	1,7	2800	3600	<b>22313 CYW33</b>	3,53
	1,7	2400	3200	<b>22313 MB</b>	3,81
	1,7	2400	3200	<b>22313 MBW33</b>	3,7
	1,7	2400	3200	<b>22313 MBK</b>	3,71
1,7	2400	3200	<b>22313 MBKW33</b>	3,65	
1,7	2400	3200	<b>22313 MA</b>	3,56	
1,7	2400	3200	<b>22313 MAC4F80W33</b>	3,77	
1,7	2400	3200	<b>22313 MAC4W502</b>	3,51	



### Spherical Roller Bearings

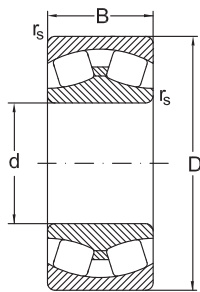

C

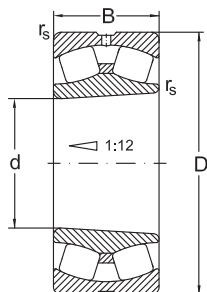

CKW33

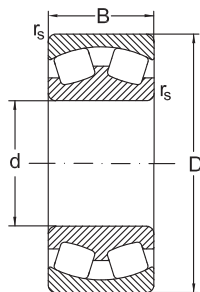

MB

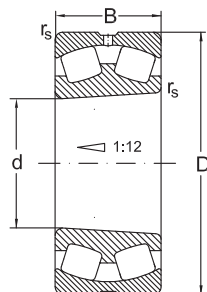

MBKW33

Dimensions				Basic radial load. Factors				
d	D	B	r <sub>s</sub> min.	dyn. C <sub>r</sub>	e	y <sub>1</sub>	y <sub>2</sub>	stat. C <sub>0r</sub>
mm				kN				kN
<b>65</b>	140	48	2,1	280	0,39	1,7	2,6	330
	125	31	1,5	180	0,26	2,6	3,9	225
	125	31	1,5	180	0,26	2,6	3,9	225
<b>70</b>	125	31	1,5	180	0,26	2,6	3,9	225
	125	31	1,5	180	0,26	2,6	3,9	225
	125	31	1,5	180	0,26	2,6	3,9	225
	125	31	1,5	180	0,26	2,6	3,9	225
	150	35	2,1	190	0,26	2,6	4	197
	150	35	2,1	190	0,26	2,6	4	197
	150	35	2,1	190	0,26	2,6	4	197
	150	51	2,1	375	0,38	1,9	2,9	455
	150	51	2,1	375	0,38	1,9	2,9	455
	150	51	2,1	375	0,38	1,9	2,9	455
	150	51	2,1	375	0,38	1,9	2,9	455
	150	51	2,1	340	0,37	1,8	2,7	420
	150	51	2,1	340	0,37	1,8	2,7	420
	150	51	2,1	340	0,37	1,8	2,7	420
	150	51	2,1	340	0,37	1,8	2,7	420
<b>75</b>	130	31	1,5	190	0,23	2,9	4,4	250
	130	31	1,5	190	0,23	2,9	4,4	250
	130	31	1,5	190	0,24	2,9	4,4	250
	130	31	1,5	190	0,24	2,9	4,4	250
	130	31	1,5	175	0,24	2,8	4,1	230
	130	31	1,5	175	0,24	2,8	4,1	230
	130	31	1,5	175	0,24	2,8	4,1	230



## Spherical Roller Bearings

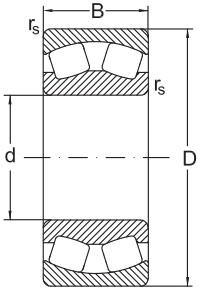

CA

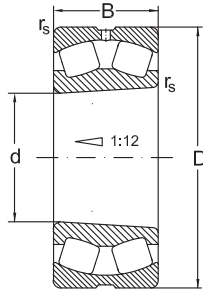

CAKW33

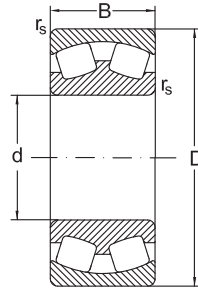

MA

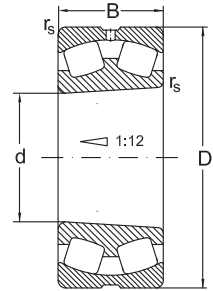

MAKW33

d	y <sub>0</sub>	Speed limit		Designation	Mass
		grease	oil		
mm		min <sup>-1</sup>		Bearing	kg
<b>65</b>	1,7	2400	3200	<b>22313 MAW502</b>	3,51
<b>70</b>	2,6	2800	3800	<b>22214 C</b>	1,82
	2,6	2800	3800	<b>22214 CK</b>	1,82
	2,6	2800	3800	<b>22214 CKW33</b>	1,8
	2,6	2800	3800	<b>22214 CW33</b>	1,82
	2,6	2600	3400	<b>21314 MBKW33</b>	3,12
	2,6	2600	3400	<b>21314 MB</b>	3,2
	2,6	2600	3400	<b>21314 MBW33</b>	3,16
	1,9	2400	3200	<b>22314 C</b>	4,32
	1,9	2400	3200	<b>22314 CK</b>	4,32
	1,9	2400	3200	<b>22314 CKW33</b>	4,21
	1,9	2400	3200	<b>22314 CW33</b>	4,3
	1,7	2200	2800	<b>22314 MB</b>	4,51
	1,7	2200	2800	<b>22314 MBW33</b>	4,51
	1,7	2200	2800	<b>22314 MBK</b>	4,37
	1,7	2200	2800	<b>22314 MBKW33</b>	4,37
	1,7	2200	2800	<b>22314 MAC4F80W33</b>	4,58
	1,7	2200	2800	<b>22314 MBW7</b>	4,53
<b>75</b>	2,9	2800	3800	<b>22215 C</b>	1,91
	2,9	2800	3800	<b>22215 CK</b>	1,88
	2,9	2800	3800	<b>22215 CW33</b>	1,89
	2,9	2800	3800	<b>22215 CKW33</b>	1,86
	2,7	2600	3400	<b>22215 MBK</b>	1,75
	2,7	2600	3400	<b>22215 MBKW33</b>	1,73
	2,7	2600	3400	<b>22215 MB</b>	1,79



### Spherical Roller Bearings

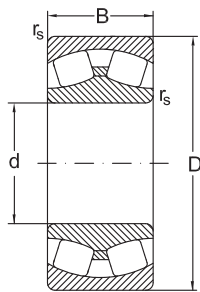

C

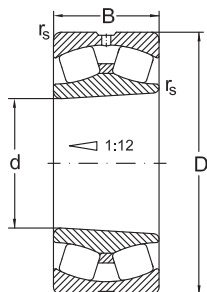

CKW33

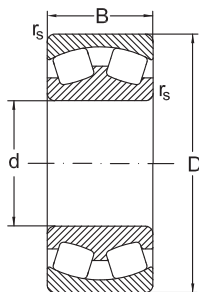

MB

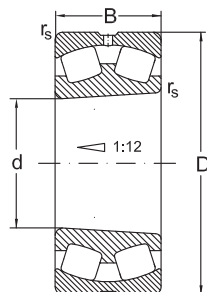

MBKW33

Dimensions				Basic radial load. Factors				
d	D	B	r <sub>s</sub> min.	dyn. C <sub>r</sub>	e	y <sub>1</sub>	y <sub>2</sub>	stat. C <sub>0r</sub>
mm				kN				kN
75	130	31	1,5	175	0,24	2,8	4,1	230
	160	37	2,1	280	0,23	2,9	4,4	360
	160	37	2,1	280	0,23	2,9	4,4	360
	160	55	2,1	415	0,38	1,8	2,6	520
	160	55	2,1	415	0,38	1,8	2,6	520
	160	55	2,1	415	0,38	1,8	2,6	520
	160	55	2,1	415	0,38	1,8	2,6	520
	160	55	2,1	380	0,34	1,9	2,9	475
	160	55	2,1	380	0,34	1,9	2,9	475
	160	55	2,1	380	0,34	1,9	2,9	475
	160	55	2,1	380	0,34	1,9	2,9	475
	160	55	2,1	380	0,34	1,9	2,9	475
80	140	33	2	210	0,25	2,6	4	275
	140	33	2	210	0,25	2,6	4	275
	140	33	2	210	0,25	2,6	4	275
	140	33	2	210	0,25	2,6	4	275
	140	33	2	210	0,25	2,6	4	275
	140	33	2	210	0,25	2,6	4	275
	140	33	2	210	0,25	2,6	4	275
	140	33	2	210	0,25	2,6	4	275
	140	33	2	195	0,24	2,8	4,1	250
	140	33	2	195	0,24	2,8	4,1	250
	140	33	2	195	0,24	2,8	4,1	250
	140	33	2	195	0,24	2,8	4,1	250
	170	39	2,1	310	0,23	2,9	4,2	400

## Spherical Roller Bearings

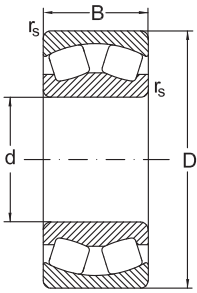

CA

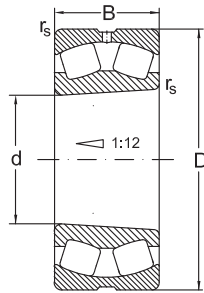

CAKW33

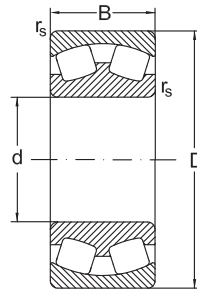

MA

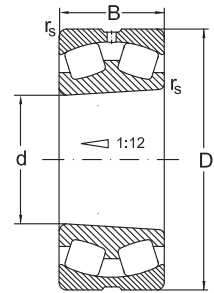

MAKW33

d	$y_0$	Speed limit		Designation	Mass
		grease	oil		
mm		$\text{min}^{-1}$		Bearing	kg
75	2,7	2600	3400	<b>22215 MBW33</b>	1,77
	2,9	2400	3200	<b>21315 CW33</b>	3,78
	2,9	2400	3200	<b>21315 CKW33</b>	3,73
	1,7	2200	3000	<b>22315 C</b>	5,28
	1,7	2200	3000	<b>22315 CW33</b>	5,26
	1,7	2200	3000	<b>22315 CK</b>	5,16
	1,7	2200	3000	<b>22315 CKW33</b>	5,14
	1,9	1900	2600	<b>22315 MBK</b>	5,14
	1,9	1900	2600	<b>22315 MBKW33</b>	5,12
	1,9	1900	2600	<b>22315 MAC4F80W33</b>	5,57
	1,9	1900	2600	<b>22315 MB</b>	5,26
	1,9	1900	2600	<b>22315 MBW33</b>	5,24
80	2,6	2600	3400	<b>22216 C</b>	2,12
	2,6	2600	3400	<b>22216 CW33</b>	2,1
	2,6	2600	3400	<b>22216 CK</b>	2,07
	2,6	2600	3400	<b>22216 CKW33</b>	2,05
	2,6	2600	3400	<b>22216 CY</b>	2,13
	2,6	2600	3400	<b>22216 CYK</b>	2,13
	2,6	2600	3400	<b>22216 CYKW33</b>	2,06
	2,6	2600	3400	<b>22216 CYW33</b>	2,11
	2,7	2400	3200	<b>22216 MBK</b>	2,09
	2,7	2400	3200	<b>22216 MBKW33</b>	2,07
	2,7	2400	3200	<b>22216 MB</b>	2,14
	2,7	2200	3000	<b>22216 MBW33</b>	2,1
	2,8	2200	3000	<b>21316 CW33</b>	4,26



### Spherical Roller Bearings

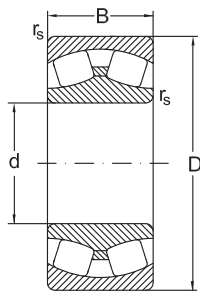

C

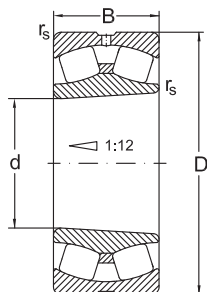

CKW33

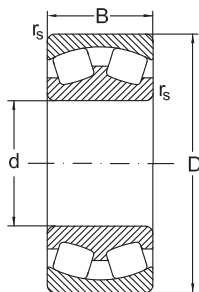

MB

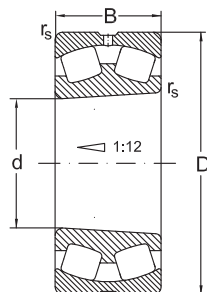

MBKW33

Dimensions				Basic radial load. Factors				
d	D	B	r <sub>s</sub> min.	dyn. C <sub>r</sub>	e	y <sub>1</sub>	y <sub>2</sub>	stat. C <sub>0r</sub>
mm				kN				kN
80	170	39	2,1	310	0,23	2,9	4,2	400
	170	58	2,1	450	0,35	1,9	2,9	550
	170	58	2,1	450	0,35	1,9	2,9	550
	170	58	2,1	450	0,35	1,9	2,9	550
	170	58	2,1	450	0,35	1,9	2,9	550
	170	58	2,1	410	0,25	2,6	4	500
	170	58	2,1	410	0,25	2,6	4	500
	170	58	2,1	410	0,25	2,6	4	500
	170	58	2,1	410	0,25	2,6	4	500
	170	58	2,1	410	0,25	2,6	4	500
85	150	36	2	250	0,26	2,6	3,9	325
	150	36	2	250	0,26	2,6	3,9	325
	150	36	2	250	0,26	2,6	3,9	325
	150	36	2	250	0,26	2,6	3,9	325
	150	36	2	230	0,25	2,7	4	295
	150	36	2	230	0,25	2,7	4	295
	150	36	2	230	0,25	2,7	4	295
	150	36	2	230	0,25	2,7	4	295
	150	36	2	230	0,25	2,7	4	295
	180	41	3	233,4	0,22	3	4,5	244
	180	41	3	350	0,22	3	4,5	450
	180	41	3	350	0,22	3	4,5	450
	180	60	3	500	0,33	2	3	620
	180	60	3	500	0,33	2	3	620
	180	60	3	500	0,33	2	3	620

### Spherical Roller Bearings

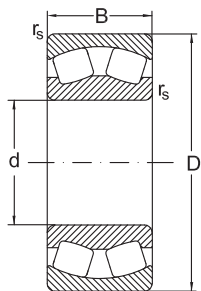

CA

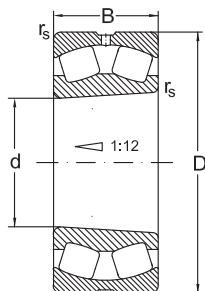

CAKW33

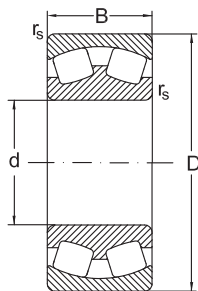

MA

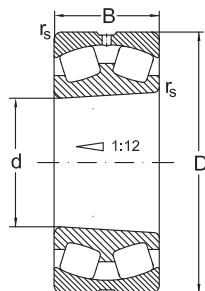

MAKW33

d	y <sub>0</sub>	Speed limit		Designation	Mass
		grease	oil		
mm		min <sup>-1</sup>		Bearing	kg
80	2,8	2200	3000	<b>21316 CKW33</b>	4,2
	1,8	2000	2600	<b>22316 C</b>	6,33
	1,8	2000	2600	<b>22316 CK</b>	6,14
	1,8	2000	2600	<b>22316 CKW33</b>	6,12
	1,8	2000	2600	<b>22316 CW33</b>	6,27
	2,6	1800	2400	<b>22316 MAC4F80W33</b>	6,95
	2,6	1800	2400	<b>22316 MBK</b>	6,11
	2,6	1800	2400	<b>22316 MB</b>	6,25
	2,6	1800	2400	<b>22316 MBW33</b>	6,23
	2,6	1800	2400	<b>22316 MBKW33</b>	6,09
85	2,6	2400	3200	<b>22217 C</b>	2,57
	2,6	2400	3200	<b>22217 CK</b>	2,52
	2,6	2400	3200	<b>22217 CW33</b>	2,56
	2,6	2400	3200	<b>22217 CKW33</b>	2,5
	2,6	2200	2800	<b>22217 MB</b>	2,76
	2,6	2200	2800	<b>22217 MBK</b>	2,7
	2,6	2200	2800	<b>22217 MBKW33</b>	2,69
	2,6	2200	2800	<b>22217 MBW7</b>	2,76
	2,6	2200	2800	<b>22217 MBW33</b>	2,75
	2,9	2100	2600	<b>21317 MBKW33</b>	5,1
	2,9	2200	2800	<b>21317 C</b>	5,1
	2,9	2200	2800	<b>21317 CK</b>	5
	2	1800	2400	<b>22317 C</b>	7,68
	2	1800	2400	<b>22317 CK</b>	7,52
	2	1800	2400	<b>22317 CKW33</b>	7,47



### Spherical Roller Bearings

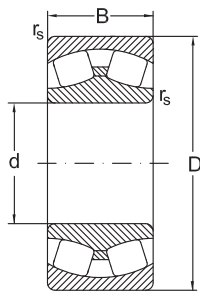

C

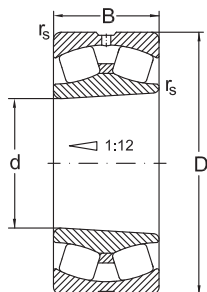

CKW33

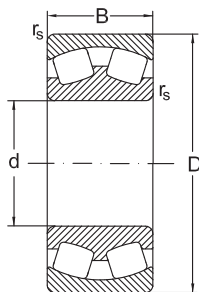

MB

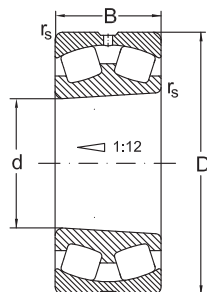

MBKW33

Dimensions				Basic radial load. Factors				
d	D	B	r <sub>s</sub> min.	dyn. C <sub>r</sub>	e	y <sub>1</sub>	y <sub>2</sub>	stat. C <sub>0r</sub>
mm				kN				kN
85	180	60	3	460	0,22	3	4,5	570
	180	60	3	406	0,37	1,8	2,7	507
	180	60	3	406	0,37	1,8	2,7	507
	180	60	3	406	0,37	1,8	2,7	507
	180	60	3	406	0,37	1,8	2,7	507
	180	60	3	406	0,37	1,8	2,7	507
	180	60	3	406	0,37	1,8	2,7	507
90	160	40	2	305	0,27	2,5	3,8	410
	160	40	2	305	0,27	2,5	3,8	410
	160	40	2	305	0,27	2,5	3,8	410
	160	40	2	305	0,27	2,5	3,8	410
	160	40	2	305	0,27	2,5	3,8	410
	160	40	2	305	0,27	2,5	3,8	410
	160	40	2	305	0,27	2,5	3,8	410
	160	40	2	305	0,27	2,5	3,8	410
	160	40	2	280	0,26	2,6	3,8	375
	160	40	2	280	0,26	2,6	3,8	375
	160	40	2	280	0,26	2,6	3,8	375
	160	40	2	280	0,26	2,6	3,8	375
	160	52,4	2	340	0,34	2	3	485
	160	52,4	2	340	0,34	2	3	485
	160	52,4	2	340	0,34	2	3	485
	160	52,4	2	340	0,34	2	3	485
	190	43	3	385	0,22	3	4,5	510
190	43	3	385	0,22	3	4,5	510	

## Spherical Roller Bearings

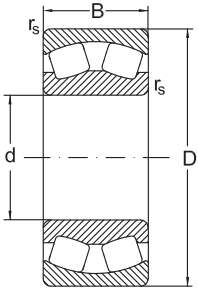

CA

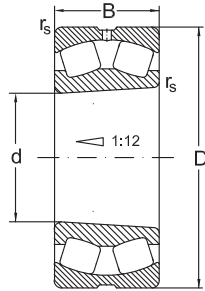

CAKW33

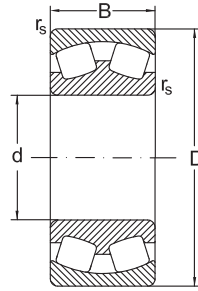

MA

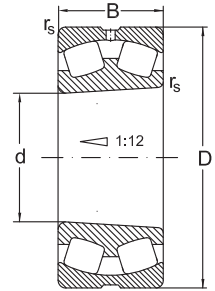

MAKW33

d	$y_0$	Speed limit		Designation	Mass
		grease	oil		
mm		min <sup>-1</sup>		Bearing	kg
85	2,9	2200	2800	<b>22317 CA</b>	7,64
	1,8	1800	2400	<b>22317 MBW33</b>	7,17
	1,8	1700	2200	<b>22317 MBK</b>	7,07
	1,8	1700	2200	<b>22317 MAC4F80W33</b>	7,88
	1,8	1700	2200	<b>22317 MB</b>	7,33
	1,8	1700	2200	<b>22317 MBW20</b>	7,23
	1,8	1700	2200	<b>22317 MBKW33</b>	7,01
90	2,5	2200	3000	<b>22218 C</b>	3,4
	2,5	2200	3000	<b>22218 CW33</b>	3,38
	2,5	2200	3000	<b>22218 CK</b>	3,33
	2,5	2200	3000	<b>22218 CKW33</b>	3,31
	2,5	2200	3000	<b>22218 CY</b>	3,41
	2,5	2200	3000	<b>22218 CYK</b>	3,34
	2,5	2200	3000	<b>22218 CYKW33</b>	3,33
	2,5	2200	3000	<b>22218 CYW33</b>	3,39
	2,5	2200	2800	<b>22218 MBK</b>	3,47
	2,5	2200	2800	<b>22218 MBKW33</b>	3,46
	2,5	2200	2800	<b>22218 MBW33</b>	3,46
	2,5	2200	2800	<b>22218 MB</b>	3,57
	2	1500	2000	<b>23218 MBKW33</b>	4,23
	2	1500	2000	<b>23218 MB</b>	4,37
	2	1500	2000	<b>23218 MBK</b>	4,25
	2	1500	2000	<b>23218 MBW33</b>	4,35
	2,9	2200	2800	<b>21318 C</b>	5,8
	2,9	2200	2800	<b>21318 CK</b>	5,7



### Spherical Roller Bearings

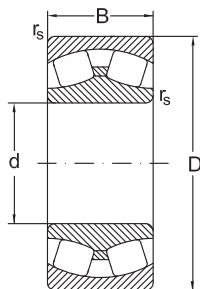

C

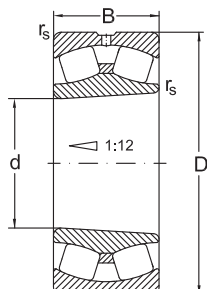

CKW33

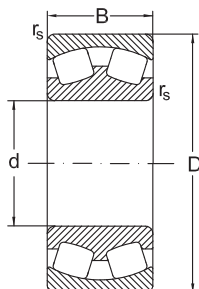

MB

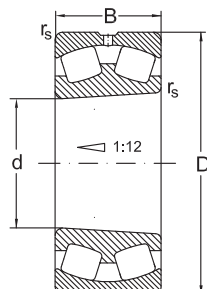

MBKW33

Dimensions				Basic radial load. Factors				
d	D	B	r <sub>s</sub> min.	dyn. C <sub>r</sub>	e	y <sub>1</sub>	y <sub>2</sub>	stat. C <sub>0r</sub>
mm				kN				kN
90	190	64	3	570	0,36	1,9	2,8	730
	190	64	3	570	0,36	1,9	2,8	730
	190	64	3	570	0,36	1,9	2,8	730
	190	64	3	570	0,36	1,9	2,8	730
	190	64	3	570	0,36	1,9	2,8	730
	190	64	3	570	0,36	1,9	2,8	730
	190	64	3	570	0,36	1,9	2,8	730
	190	64	3	570	0,36	1,9	2,8	730
	190	64	3	530	0,37	1,8	2,7	670
	190	64	3	530	0,37	1,8	2,7	670
	190	64	3	530	0,37	1,8	2,7	670
	190	64	3	530	0,37	1,8	2,7	670
	190	64	3	530	0,37	1,8	2,7	670
	190	64	3	530	0,37	1,8	2,7	670
95	170	43	2,1	340	0,24	2,8	4,2	450
	170	43	2,1	340	0,24	2,8	4,2	450
	170	43	2,1	340	0,24	2,8	3,8	450
	170	43	2,1	340	0,24	2,8	4,2	450
	170	43	2,1	340	0,24	2,8	4,2	450
	170	43	2,1	310	0,26	2,6	3,8	415
	170	43	2,1	310	0,26	2,6	3,8	415
	170	43	2,1	310	0,26	2,6	3,8	415
	170	43	2,1	310	0,26	2,6	3,8	415
	200	45	3	420	0,22	3	4,5	580
	200	45	3	385	0,22	3,1	4,6	530





### Spherical Roller Bearings

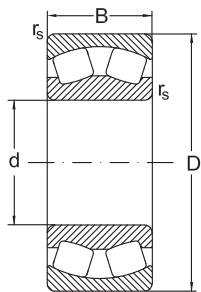

CA

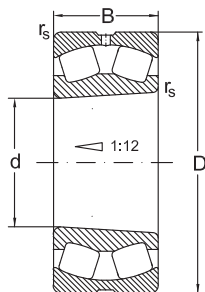

CAKW33

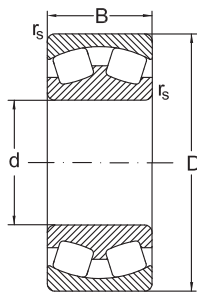

MA

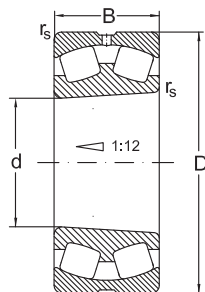

MAKW33

d	y <sub>0</sub>	Speed limit		Designation	Mass
		grease	oil		
mm		min <sup>-1</sup>		Bearing	kg
90	1,8	1800	2400	<b>22318 C</b>	8,68
	1,8	1800	2400	<b>22318 CK</b>	8,5
	1,8	1800	2400	<b>22318 CW33</b>	8,6
	1,8	1800	2400	<b>22318 CKW33</b>	8,5
	1,8	1800	2400	<b>22318 CY</b>	8,73
	1,8	1800	2400	<b>22318 CYK</b>	8,55
	1,8	1800	2400	<b>22318 CYKW33</b>	8,53
	1,8	1800	2400	<b>22318 CYW33</b>	8,71
	1,8	1700	2200	<b>22318 MBK</b>	8,5
	1,8	1700	2200	<b>22318 MBKW33</b>	8,49
	1,8	1700	2200	<b>22318 MA</b>	9,21
	1,8	1700	2200	<b>22318 MAC4F80W33</b>	9,2
	1,8	1700	2200	<b>22318 MB</b>	8,69
	1,8	1700	2200	<b>22318 MBW33</b>	8,68
95	2,8	2200	2800	<b>22219 C</b>	4,26
	2,8	2200	2800	<b>22219 CK</b>	4,17
	2,8	2200	2800	<b>22219 CKW33</b>	4,15
	2,8	2200	2800	<b>22219 CW25</b>	4,24
	2,8	2200	2800	<b>22219 CW33</b>	4,24
	2,5	2000	2600	<b>22219 MBK</b>	4,3
	2,5	2000	2600	<b>22219 MBKW33</b>	4,28
	2,5	2000	2600	<b>22219 MB</b>	4,32
	2,5	2000	2600	<b>22219 MBW25</b>	4,32
	3	2000	2600	<b>21319 CA</b>	7,43
	3	2000	2600	<b>21319 MB</b>	7,38



### Spherical Roller Bearings

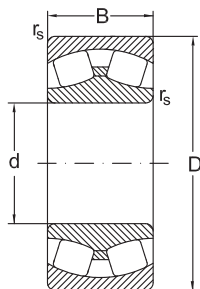

C

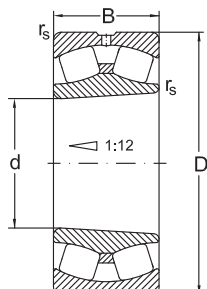

CKW33

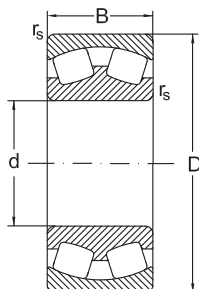

MB

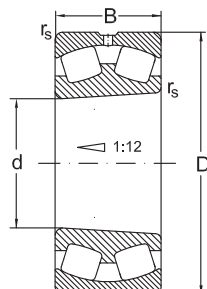

MBKW33

Dimensions				Basic radial load. Factors				
d	D	B	r <sub>s</sub> min.	dyn. C <sub>r</sub>	e	y <sub>1</sub>	y <sub>2</sub>	stat. C <sub>0r</sub>
mm				kN				kN
95	200	45	3	385	0,22	3,1	4,6	530
	200	67	3	620	0,35	1,9	2,9	800
	200	67	3	620	0,35	1,9	2,9	800
	200	67	3	620	0,35	1,9	2,9	800
	200	67	3	620	0,35	1,9	2,9	800
	200	67	3	620	0,35	1,9	2,9	800
	200	67	3	570	0,35	1,9	2,7	740
	200	67	3	570	0,38	1,8	2,7	740
	200	67	3	570	0,38	1,8	2,7	740
	200	67	3	570	0,38	1,8	2,7	740
	200	67	3	570	0,38	1,8	2,7	740
	200	67	3	570	0,38	1,8	2,7	740
100	165	52	2	347	0,28	2,4	3,5	534
	165	52	2	355	0,31	2,2	3,2	540
	165	52	2	355	0,31	2,2	3,2	540
	165	52	2	355	0,31	2,2	3,2	540
	165	52	2	355	0,31	2,2	3,2	540
	180	46	2,1	375	0,24	2,8	4,2	500
	180	46	2,1	375	0,24	2,8	4,2	500
	180	46	2,1	375	0,24	2,8	4,2	500
	180	46	2,1	375	0,24	2,8	4,2	500
	180	46	2,1	340	0,27	2,5	3,7	455
	180	46	2,1	340	0,27	2,5	3,7	455
	180	46	2,1	340	0,27	2,5	3,7	455

## Spherical Roller Bearings

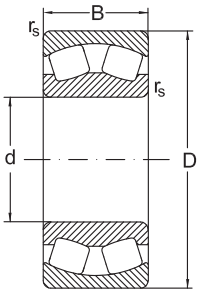

CA

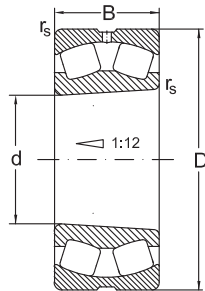

CAKW33

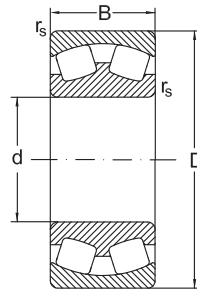

MA

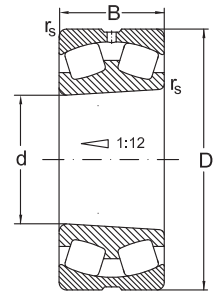

MAKW33

d	$y_0$	Speed limit		Designation	Mass
		grease	oil		
mm		min <sup>-1</sup>		Bearing	kg
95	3	2000	2600	<b>21319 MBK</b>	7,28
	1,8	1700	2200	<b>22319 C</b>	8,83
	1,8	1700	2200	<b>22319 CK</b>	8,61
	1,8	1700	2200	<b>22319 CKW33</b>	8,5
	1,8	1700	2200	<b>22319 CW25</b>	8,71
	1,8	1700	2200	<b>22319 CW33</b>	8,72
	1,7	1500	2000	<b>22319 MBK</b>	9,88
	1,7	1500	2000	<b>22319 MAC4F80W33</b>	10,7
	1,7	1500	2000	<b>22319 MB</b>	10,1
	1,7	1500	2000	<b>22319 MBW25</b>	9,97
	1,7	1500	2000	<b>22319 MBW33</b>	9,97
	1,7	1500	2000	<b>22319 MBKW33</b>	9,97
100	2,3	2200	3000	<b>23120 CW33</b>	5
	2,1	2000	2600	<b>23120 MBKW33</b>	4,53
	2,1	2000	2600	<b>23120 MB</b>	4,7
	2,1	2000	2600	<b>23120 MBK</b>	4,57
	2,1	2000	2600	<b>23120 MBW33</b>	4,66
	2,8	2200	2800	<b>22220 C</b>	5,24
	2,8	2200	2800	<b>22220 CK</b>	5,13
	2,8	2200	2800	<b>22220 CKW33</b>	5,09
	2,8	2200	2800	<b>22220 CW33</b>	5,23
	2,4	2000	2600	<b>22220 MBK</b>	5,24
	2,4	2000	2600	<b>22220 MB</b>	5,35
	2,4	2000	2600	<b>22220 MBW33</b>	5,31
	2,4	2000	2600	<b>22220 MBKW33</b>	5,2



### Spherical Roller Bearings

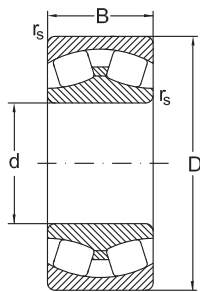

C

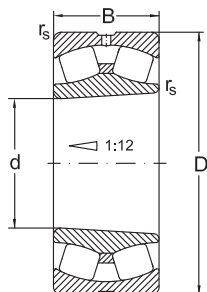

CKW33

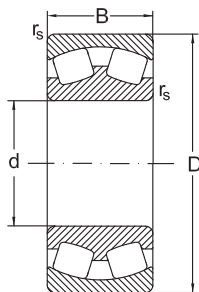

MB

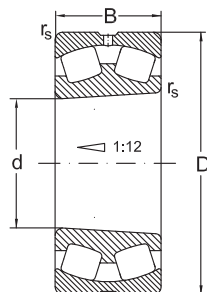

MBKW33

Dimensions				Basic radial load. Factors				
d	D	B	r <sub>s</sub> min.	dyn. C <sub>r</sub>	e	y <sub>1</sub>	y <sub>2</sub>	stat. C <sub>0r</sub>
mm				kN				kN
100	180	60,3	2,1	495	0,33	2	3	720
	180	60,3	2,1	495	0,33	2	3	720
	180	60,3	2,1	495	0,33	2	3	720
	180	60,3	2,1	495	0,33	2	3	720
	180	60,3	2,1	455	0,33	2	3	660
	180	60,3	2,1	455	0,33	2	3	660
	180	60,3	2,1	455	0,33	2	3	660
	180	60,3	2,1	455	0,33	2	3	660
	180	60,3	2,1	455	0,33	2	3	660
	180	60,3	2,1	455	0,33	2	3	660
	180	60,3	2,1	455	0,33	2	3	660
	215	47	3	460	0,22	3,1	4,7	640
	215	47	3	425	0,22	3,1	4,7	580
	215	47	3	425	0,22	3,1	4,7	580
	215	73	3	730	0,35	1,9	2,9	960
	215	73	3	730	0,35	1,9	2,9	960
	215	73	3	730	0,35	1,9	2,9	960
	215	73	3	730	0,35	1,9	2,9	960
	215	73	3	670	0,37	1,8	2,9	880
	215	73	3	670	0,37	1,8	2,9	880
215	73	3	670	0,37	1,8	2,9	880	
215	73	3	670	0,37	1,8	2,9	880	
215	73	3	670	0,37	1,8	2,7	880	
215	73	3	670	0,37	1,8	2,7	880	

## Spherical Roller Bearings

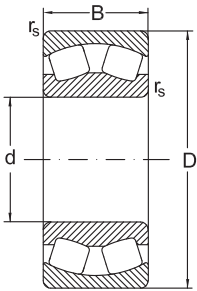

CA

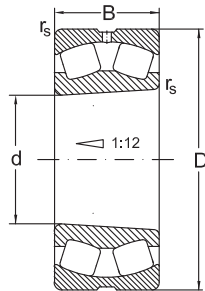

CAKW33

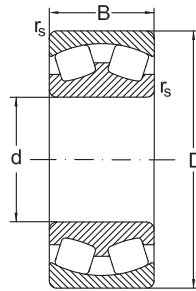

MA

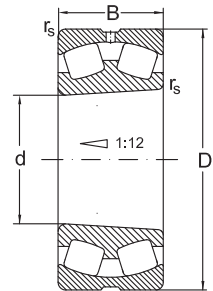

MAKW33

d	y <sub>0</sub>	Speed limit		Designation	Mass
		grease	oil		
mm		min <sup>-1</sup>		Bearing	kg
100	2	1700	2200	<b>23220 C</b>	7,34
	2	1700	2200	<b>23220 CK</b>	7,19
	2	1700	2200	<b>23220 CKW33</b>	7,13
	2	1700	2200	<b>23220 CW33</b>	7,28
	2	1500	2000	<b>23220 MA</b>	7,04
	2	1500	2000	<b>23220 MAK</b>	6,85
	2	1500	2000	<b>23220 MAW33</b>	7,03
	2	1500	2000	<b>23220 MAKW33</b>	6,84
	2	1500	2000	<b>23220 MBK</b>	6,8
	2	1500	2000	<b>23220 MB</b>	6,99
	2	1500	2000	<b>23220 MBW33</b>	6,98
	3,1	1800	2400	<b>21320 CA</b>	9,07
	3,1	1700	2200	<b>21320 MB</b>	8,96
	3,1	1700	2200	<b>21320 MBK</b>	8,84
	1,9	1500	2000	<b>22320 C</b>	12,95
	1,9	1500	2000	<b>22320 CK</b>	12,67
	1,9	1500	2000	<b>22320 CW33</b>	12,83
	1,9	1500	2000	<b>22320 CKW33</b>	12,55
	1,9	1500	2000	<b>22320 CYW33</b>	12,83
	1,7	1400	1800	<b>22320 MBK</b>	13,21
1,7	1400	1800	<b>22320 MBKW33</b>	13,09	
1,7	1400	1800	<b>22320 MA</b>	13,89	
1,7	1400	1800	<b>22320 MAC4F80W33</b>	13,78	
1,7	1400	1800	<b>22320 MB</b>	13,49	
1,7	1400	1800	<b>22320 MBW33</b>	13,37	



### Spherical Roller Bearings

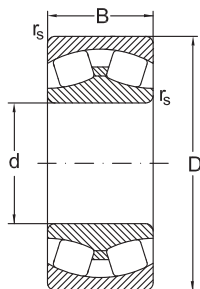

C

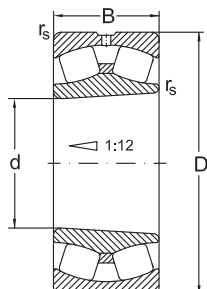

CKW33

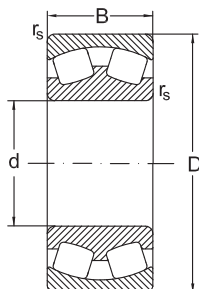

MB

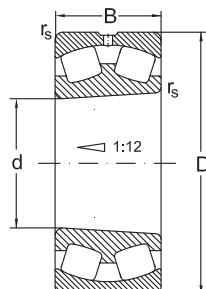

MBKW33

Dimensions				Basic radial load. Factors				
d	D	B	r <sub>s</sub> min.	dyn. C <sub>r</sub>	e	y <sub>1</sub>	y <sub>2</sub>	stat. C <sub>0r</sub>
mm				kN				kN
110	170	45	2	295	0,24	2,8	4,2	485
	170	45	2	295	0,24	2,8	4,2	485
	170	45	2	295	0,24	2,8	4,2	485
	170	45	2	295	0,24	2,8	4,2	485
	180	56	2	450	0,3	2,3	3,4	700
	180	56	2	410	0,3	2,3	3,3	640
	180	56	2	410	0,3	2,3	3,3	640
	180	56	2	410	0,3	2,3	3,3	640
	180	56	2	410	0,3	2,3	3,3	640
	180	69	2	466	0,39	1,7	2,6	771
	180	69	2	466	0,39	1,7	2,6	771
	180	69	2	466	0,39	1,7	2,6	771
	180	69	2	466	0,39	1,7	2,6	771
	200	53	2,1	515	0,25	2,7	4	650
	200	53	2,1	515	0,25	2,7	4	650
	200	53	2,1	515	0,25	2,7	4	650
	200	53	2,1	515	0,25	2,7	4	650
	200	53	2,1	455	0,28	2,4	3,5	585
	200	53	2,1	455	0,28	2,4	3,5	585
	200	53	2,1	455	0,28	2,4	3,5	585
200	53	2,1	455	0,28	2,4	3,5	585	
200	69,8	2,1	620	0,33	2	3	920	
200	69,8	2,1	570	0,37	1,8	2,7	840	
200	69,8	2,1	570	0,37	1,8	2,7	840	
200	69,8	2,1	570	0,37	1,8	2,7	840	

## Spherical Roller Bearings

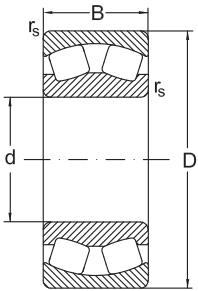

CA

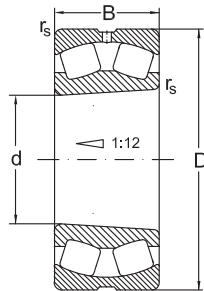

CAKW33

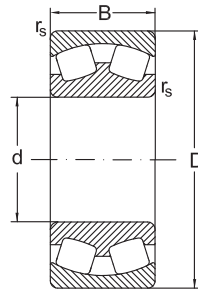

MA

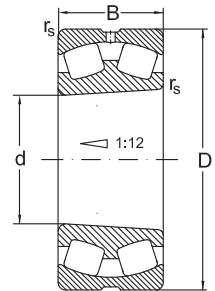

MAKW33

d	$y_0$	Speed limit		Designation	Mass
		grease	oil		
mm		min <sup>-1</sup>		Bearing	kg
110	2,7	2000	2600	<b>23022 MBK</b>	3,58
	2,7	2000	2600	<b>23022 MBKW33</b>	3,56
	2,7	2000	2600	<b>23022 MB</b>	3,8
	2,7	2000	2600	<b>23022 MBW33</b>	3,56
	2,2	2000	2600	<b>23122 C</b>	6,26
	2,2	1800	2400	<b>23122 MBK</b>	5,18
	2,2	1800	2400	<b>23122 MB</b>	5,29
	2,2	1800	2400	<b>23122 MBW33</b>	5,19
	2,2	1800	2400	<b>23122 MBKW33</b>	5,07
	1,7	1200	1600	<b>24122 CA</b>	6,9
	1,7	1200	1600	<b>24122 CAW33</b>	6,82
	1,7	1200	1600	<b>24122 CAK30</b>	6,8
	1,7	1200	1600	<b>24122 CAK30W33</b>	6,77
	2,5	1800	2400	<b>22222 C</b>	7,52
	2,5	1800	2400	<b>22222 CK</b>	7,45
	2,5	1800	2400	<b>22222 CKW33</b>	7,39
	2,5	1800	2400	<b>22222 CW33</b>	7,45
	2,3	1700	2200	<b>22222 MBK</b>	7,1
	2,3	1700	2200	<b>22222 MB</b>	7,31
	2,3	1700	2200	<b>22222 MBW33</b>	7,1
2,3	1700	2200	<b>22222 MBKW33</b>	7	
2	1400	1800	<b>23222 C</b>	10,75	
1,8	1200	1600	<b>23222 MBK</b>	9,4	
1,8	1200	1600	<b>23222 MB</b>	9,7	
1,8	1200	1600	<b>23222 MBW20</b>	9,5	



### Spherical Roller Bearings

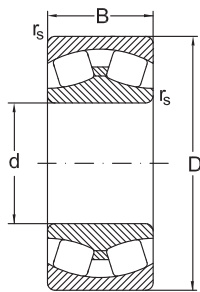

C

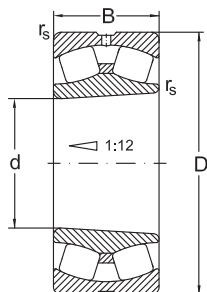

CKW33

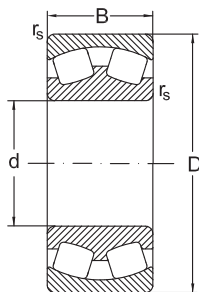

MB

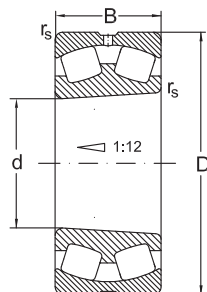

MBKW33

Dimensions				Basic radial load. Factors				
d	D	B	r <sub>s</sub> min.	dyn. C <sub>r</sub>	e	y <sub>1</sub>	y <sub>2</sub>	stat. C <sub>0r</sub>
mm				kN				kN
110	200	69,8	2,1	570	0,37	1,8	2,7	840
	200	69,8	2,1	570	0,37	1,8	2,7	840
	240	50	3	475	0,21	3,2	4,8	500
	240	50	3	475	0,21	3,2	4,8	500
	240	80	3	870	0,34	1,2	2,3	1160
	240	80	3	870	0,34	1,2	2,3	1160
	240	80	3	870	0,34	1,2	2,3	1160
	240	80	3	870	0,34	1,2	2,3	1160
	240	80	3	870	0,34	2	3	1160
	240	80	3	870	0,34	2	3	1160
	240	80	3	800	0,37	1,8	2,7	1060
	240	80	3	800	0,37	1,8	2,7	1060
	240	80	3	800	0,37	1,8	2,7	1060
	240	80	3	800	0,37	1,8	2,7	1060
	240	80	3	800	0,37	1,8	2,7	1060
	240	80	3	800	0,37	1,8	2,7	1060
120	180	46	2	365	0,22	3	4,6	610
	180	46	2	365	0,22	3	4,6	610
	180	46	2	365	0,22	3	4,6	610
	180	46	2	365	0,22	3	4,6	610
	180	46	2	335	0,24	2,8	4,2	560
	180	46	2	335	0,24	2,8	4,2	560
	180	46	2	335	0,24	2,8	4,2	560
	180	46	2	335	0,24	2,8	4,2	560



## Spherical Roller Bearings

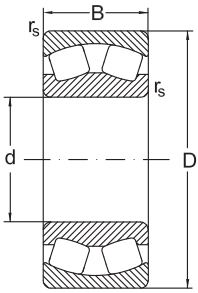

CA

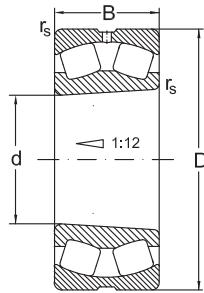

CAKW33

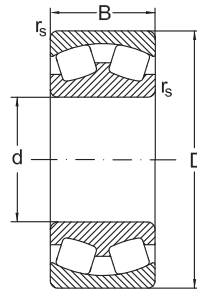

MA

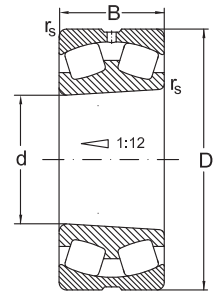

MAKW33

d	$y_0$	Speed limit		Designation	Mass
		grease	oil		
mm		min <sup>-1</sup>		Bearing	kg
110	1,8	1200	1600	<b>23222 MBW33</b>	9,45
	1,8	1200	1600	<b>23222 MBKW33</b>	9,25
	3,2	1500	2000	<b>21322 MB</b>	12
	3,2	1500	2000	<b>21322 MBK</b>	11,7
	1,2	1400	1900	<b>22322 C</b>	18
	1,2	1400	1900	<b>22322 CW33</b>	17,7
	1,2	1400	1900	<b>22322 CK</b>	17,5
	1,2	1400	1900	<b>22322 CKW33</b>	17,2
	2	1400	1900	<b>22322 CY</b>	18
	2	1400	1900	<b>22322 CYK</b>	18,5
	1,8	1300	1700	<b>22322 MBK</b>	17,2
	1,8	1300	1700	<b>22322 MBKW33</b>	17,9
	1,8	1300	1700	<b>22322 MB</b>	18,7
	1,8	1300	1700	<b>22322 MBW33</b>	18,4
	1,8	1300	1700	<b>22322 MA</b>	18,7
	1,8	1300	1700	<b>22322 MAC4F80W33</b>	18,4
	1,8	1300	1700	<b>22322 MAW33</b>	18,4
120	2,8	2000	2600	<b>23024 C</b>	4,31
	2,8	2000	2600	<b>23024 CK</b>	4,11
	2,8	2000	2600	<b>23024 CKW33</b>	4,02
	2,8	2000	2600	<b>23024 CW33</b>	4,22
	2,8	1800	2400	<b>23024 MBK</b>	4
	2,8	1800	2400	<b>23024 MB</b>	4,19
	2,8	1800	2400	<b>23024 MBW33</b>	4,1
	2,8	1800	2400	<b>23024 MBKW33</b>	3,9



### Spherical Roller Bearings

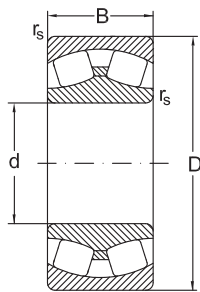

C

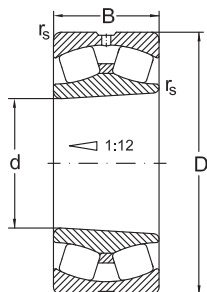

CKW33

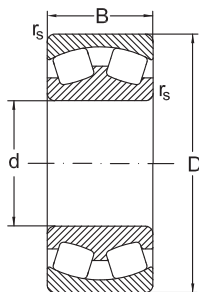

MB

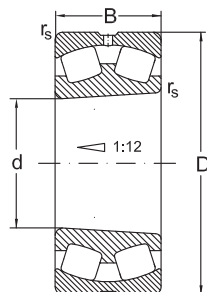

MBKW33

Dimensions				Basic radial load. Factors				
d	D	B	r <sub>s</sub> min.	dyn. C <sub>r</sub>	e	y <sub>1</sub>	y <sub>2</sub>	stat. C <sub>0r</sub>
mm				kN				kN
120	180	60	2	450	0,35	2,3	3,3	800
	180	60	2	450	0,35	2,3	3,3	800
	180	60	2	430	0,32	2,1	3,1	770
	180	60	2	430	0,32	2,1	3,1	770
	180	60	2	410	0,32	2,1	3,1	740
	180	60	2	410	0,32	2,1	3,1	740
	180	60	2	410	0,32	2,1	3,1	740
	180	60	2	410	0,32	2,1	3,1	740
	200	62	2	510	0,35	2,3	3,5	800
	200	62	2	510	0,35	2,3	3,5	800
	200	62	2	495	0,31	2,2	3,3	770
	200	62	2	495	0,31	2,2	3,3	770
	200	62	2	495	0,31	2,2	3,3	770
	200	62	2	495	0,31	2,2	3,3	770
	200	80	2	630	0,4	1,7	2,5	1050
	200	80	2	630	0,4	1,7	2,5	1050
	200	80	2	630	0,4	1,7	2,5	1050
	215	58	2,1	590	0,27	2,6	3,8	800
	215	58	2,1	590	0,27	2,6	3,8	800
	215	58	2,1	590	0,27	2,6	3,8	800
215	58	2,1	590	0,27	2,6	3,8	800	
215	58	2,1	540	0,29	2,3	3,5	740	
215	58	2,1	540	0,29	2,3	3,5	740	
215	58	2,1	540	0,29	2,3	3,5	740	
215	58	2,1	540	0,29	2,3	3,5	740	
215	76	2,1	730	0,35	1,9	2,9	1120	

## Spherical Roller Bearings

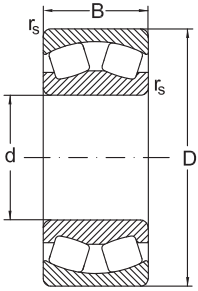

CA

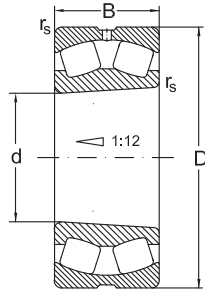

CAKW33

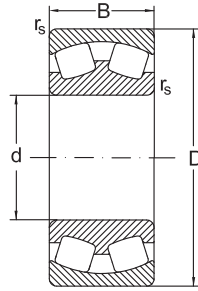

MA

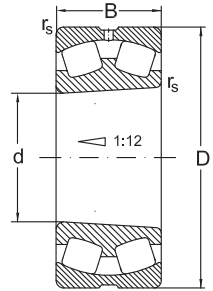

MAKW33

d	$y_0$	Speed limit		Designation	Mass
		grease	oil		
mm		min <sup>-1</sup>		Bearing	kg
120	2,2	1600	2200	<b>24024 C</b>	5,2
	2,2	1600	2200	<b>24024 CW33</b>	4,9
	2	1500	2000	<b>24024 CAW33</b>	5,4
	2	1500	2000	<b>24024 CAK30W33</b>	5,3
	2	1400	1800	<b>24024 MBK30W33</b>	5,1
	2	1400	1800	<b>24024 MB</b>	5,12
	2	1400	1800	<b>24024 MBW33</b>	5,1
	2,3	1800	2400	<b>23124 C</b>	7,8
	2,3	1800	2400	<b>23124 CW33</b>	7,7
	2,2	1700	2200	<b>23124 MBK</b>	7,9
	2,2	1700	2200	<b>23124 MB</b>	8,19
	2,2	1700	2200	<b>23124 MBW33</b>	8,13
	2,2	1700	2200	<b>23124 MBKW33</b>	7,84
	1,6	1000	1300	<b>24124 MB</b>	10,22
	1,6	1000	1300	<b>24124 MBW33</b>	10,2
	1,6	1000	1300	<b>24124 MBK30W33</b>	10,04
	2,5	1700	2200	<b>22224 C</b>	8,9
	2,5	1700	2200	<b>22224 CK</b>	8,7
	2,5	1700	2200	<b>22224 CW33</b>	8,8
	2,5	1700	2200	<b>22224 CKW33</b>	8,6
2,3	1500	2000	<b>22224 MBK</b>	9,03	
2,3	1500	2000	<b>22224 MBKW33</b>	9,09	
2,3	1500	2000	<b>22224 MB</b>	9,73	
2,3	1500	2000	<b>22224 MBW33</b>	9,53	
1,8	1300	1700	<b>23224 C</b>	13,1	



### Spherical Roller Bearings

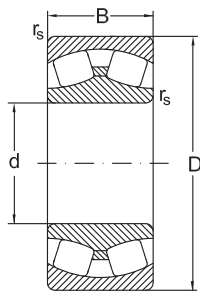

C

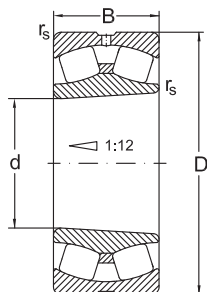

CKW33

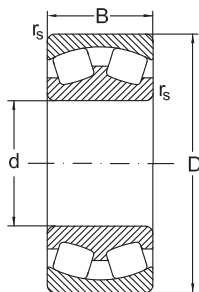

MB

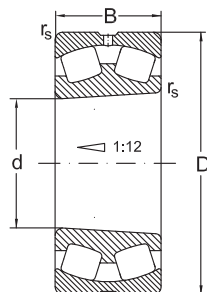

MBKW33

Dimensions				Basic radial load. Factors				
d	D	B	r <sub>s</sub> min.	dyn. C <sub>r</sub>	e	y <sub>1</sub>	y <sub>2</sub>	stat. C <sub>0r</sub>
mm				kN				kN
120	215	76	2,1	670	0,37	1,8	2,7	1020
	215	76	2,1	670	0,37	1,8	2,7	1020
	215	76	2,1	670	0,37	1,8	2,7	1020
	215	76	2,1	670	0,37	1,8	2,7	1020
	260	86	3	1010	0,35	1,9	2,9	1340
	260	86	3	1010	0,35	1,9	2,9	1340
	260	86	3	1010	0,35	1,9	2,9	1340
	260	86	3	1010	0,35	1,9	2,9	1340
	260	86	3	930	0,36	1,8	2,7	1230
	260	86	3	930	0,36	1,8	2,7	1230
	260	86	3	930	0,36	1,8	2,7	1230
	260	86	3	930	0,36	1,8	2,7	1230
	260	86	3	930	0,36	1,8	2,7	1230
	260	86	3	930	0,36	1,8	2,7	1230
130	200	52	2	450	0,27	3	4,6	730
	200	52	2	450	0,27	3	4,6	730
	200	52	2	450	0,27	3	4,6	730
	200	52	2	450	0,27	3	4,6	730
	200	52	2	410	0,23	2,9	4,4	670
	200	52	2	410	0,23	2,9	4,4	670
	200	52	2	410	0,23	2,9	4,4	670
	200	52	2	410	0,23	2,9	4,4	670
	200	69	2	530	0,34	2	3	900
	200	69	2	530	0,34	2	3	900
	200	69	2	530	0,34	2	3	900

## Spherical Roller Bearings

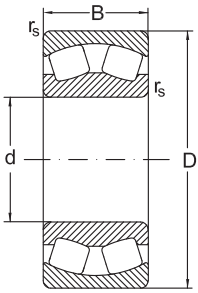

CA

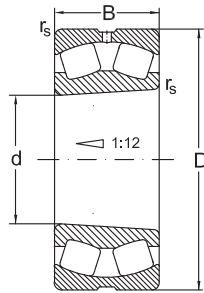

CAKW33

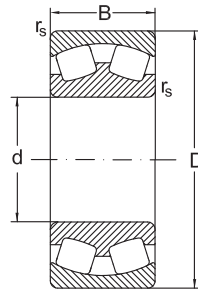

MA

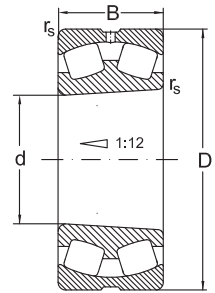

MAKW33

d	$y_0$	Speed limit		Designation	Mass
		grease	oil		
mm		min <sup>-1</sup>		Bearing	kg
120	1,8	1100	1500	<b>23224 MBK</b>	11,84
	1,8	1100	1500	<b>23224 MB</b>	12,8
	1,8	1100	1500	<b>23224 MBW33</b>	11,73
	1,8	1100	1500	<b>23224 MBKW33</b>	11
	1,8	1300	1700	<b>22324 C</b>	23,76
	1,8	1300	1700	<b>22324 CK</b>	23,29
	1,8	1300	1700	<b>22324 CKW33</b>	23,05
	1,8	1300	1700	<b>22324 CW33</b>	23,52
	1,8	1100	1500	<b>22324 MAK4F80W33</b>	23,4
	1,8	1100	1500	<b>22324 MBK</b>	22,93
	1,8	1100	1500	<b>22324 MAC4F80W33</b>	23,93
	1,8	1100	1500	<b>22324 MB</b>	23,39
	1,8	1100	1500	<b>22324 MBW33</b>	23,18
	1,8	1100	1500	<b>22324 MBKW33</b>	22,71
130	2,9	1800	2400	<b>23026 C</b>	6,09
	2,9	1800	2400	<b>23026 CK</b>	5,7
	2,9	1800	2400	<b>23026 CKW33</b>	5,4
	2,9	1800	2400	<b>23026 CW33</b>	5,8
	2,8	1700	2200	<b>23026 MBK</b>	5,61
	2,8	1700	2200	<b>23026 MB</b>	5,78
	2,8	1700	2200	<b>23026 MBW33</b>	5,73
	2,8	1700	2200	<b>23026 MBKW33</b>	5,56
	1,9	1200	1600	<b>24026 C</b>	
	1,9	1200	1600	<b>24026 CW33</b>	
	1,9	1200	1600	<b>24026 MB</b>	7,98



### Spherical Roller Bearings

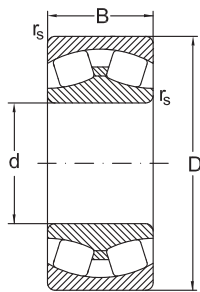

C

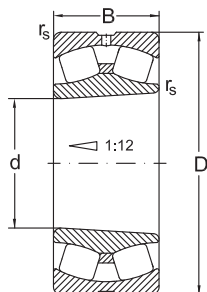

CKW33

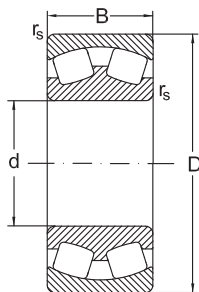

MB

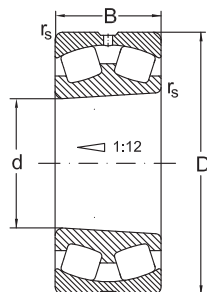

MBKW33

Dimensions				Basic radial load. Factors				
d	D	B	r <sub>s</sub> min.	dyn. C <sub>r</sub>	e	y <sub>1</sub>	y <sub>2</sub>	stat. C <sub>0r</sub>
mm				kN				kN
130	200	69	2	530	0,34	2	3	900
	200	69	2	530	0,34	2	3	900
	210	64	2	590	0,28	2,4	3,6	940
	210	64	2	540	0,3	2,3	3,3	860
	210	64	2	540	0,3	2,3	3,3	860
	210	64	2	540	0,3	2,3	3,3	860
	210	64	2	540	0,3	2,3	3,3	860
	210	80	2	650	0,37	1,8	2,7	1100
	210	80	2	650	0,37	1,8	2,7	1100
	210	80	2	650	0,37	1,8	2,7	1100
	230	64	3	660	0,29	2,3	3,5	960
	230	64	3	660	0,29	2,3	3,5	960
	230	64	3	660	0,29	2,3	3,5	960
	230	64	3	660	0,29	2,3	3,5	960
	230	64	3	660	0,29	2,3	3,5	960
	230	64	3	660	0,29	2,3	3,5	960
	230	64	3	600	0,29	2,3	3,4	880
	230	64	3	600	0,29	2,3	3,4	880
	230	64	3	600	0,29	2,3	3,4	880
	230	64	3	600	0,29	2,3	3,4	880
230	80	3	830	0,33	2	3	1270	
230	80	3	760	0,35	1,9	2,8	1170	
230	80	3	760	0,35	1,9	2,8	1170	
230	80	3	760	0,35	1,9	2,8	1170	

## Spherical Roller Bearings

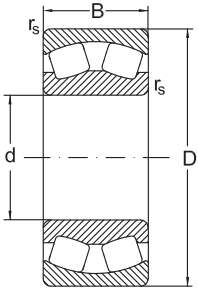

CA

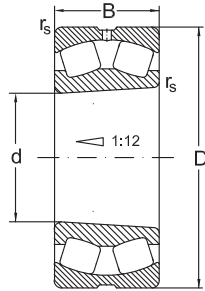

CAKW33

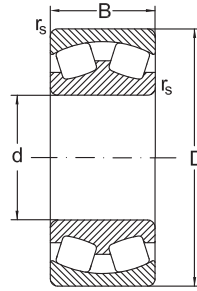

MA

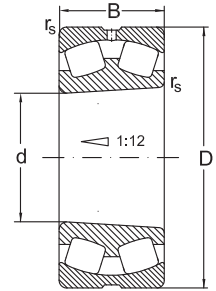

MAKW33

d	$y_0$	Speed limit		Designation	Mass
		grease	oil		
mm		min <sup>-1</sup>		Bearing	kg
130	1,9	1200	1600	<b>24026 MBW33</b>	7,99
	1,9	1200	1600	<b>24026 MBK30W33</b>	7,78
	2,5	1700	2200	<b>23126 C</b>	9,7
	2,2	1500	2000	<b>23126 MBK</b>	8,36
	2,2	1500	2000	<b>23126 MB</b>	8,66
	2,2	1500	2000	<b>23126 MBW33</b>	8,4
	2,2	1500	2000	<b>23126 MBKW33</b>	8,16
	1,8	900	1200	<b>24126 MB</b>	11,4
	1,8	900	1200	<b>24126 MBW33</b>	11,07
	1,8	900	1200	<b>24126 MBK30W33</b>	10,64
	2,3	1700	2200	<b>22226 C</b>	11,14
	2,3	1700	2200	<b>22226 CW33</b>	10,9
	2,3	1700	2200	<b>22226 CK</b>	10,87
	2,3	1700	2200	<b>22226 CKW33</b>	10,6
	2,3	1700	2200	<b>22226 CY</b>	11,14
	2,3	1700	2200	<b>22226 CYK</b>	10,87
	2,3	1700	2200	<b>22226 CYW33</b>	10,9
	2,2	1500	2000	<b>22226 MB</b>	11,47
	2,2	1500	2000	<b>22226 MBKW33</b>	11,2
	2,2	1500	2000	<b>22226 MBW33</b>	11,3
	2,2	1500	2000	<b>22226 MBK</b>	11,35
2	1300	1700	<b>23226 C</b>	15,86	
1,9	1100	1500	<b>23226 MBK</b>	14,52	
1,9	1100	1500	<b>23226 MB</b>	14,97	
1,9	1100	1500	<b>23226 MBW33</b>	14,95	



### Spherical Roller Bearings

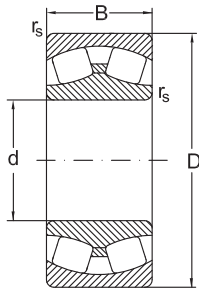

C

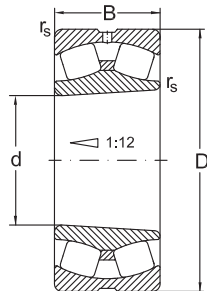

CKW33

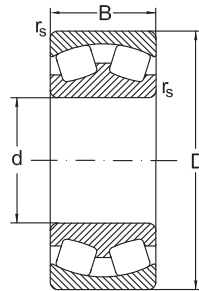

MB

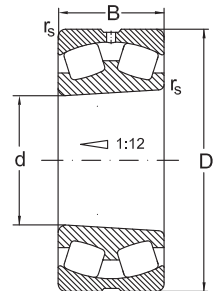

MBKW33

Dimensions				Basic radial load. Factors				
d	D	B	r <sub>s</sub> min.	dyn. C <sub>r</sub>	e	y <sub>1</sub>	y <sub>2</sub>	stat. C <sub>0r</sub>
mm				kN				kN
130	230	80	3	760	0,35	1,9	2,8	1170
	280	93	4	1170	0,35	1,9	2,9	1580
	280	93	4	1170	0,35	1,9	2,9	1580
	280	93	4	1170	0,35	1,9	2,9	1580
	280	93	4	1170	0,35	1,9	2,9	1580
	280	93	4	1170	0,35	1,9	2,9	1580
	280	93	4	1080	0,37	1,8	2,7	1450
	280	93	4	1080	0,37	1,8	2,7	1450
	280	93	4	1080	0,37	1,8	2,7	1450
	280	93	4	1080	0,37	1,8	2,7	1450
	280	93	4	1080	0,37	1,8	2,7	1450
140	210	53	2	475	0,22	3	4,6	820
	210	53	2	475	0,22	3	4,6	820
	210	53	2	475	0,22	3	4,6	820
	210	53	2	475	0,22	3	4,6	820
	210	53	2	435	0,22	3	4,6	750
	210	53	2	435	0,22	3	4,6	750
	210	53	2	435	0,22	3	4,6	750
	210	53	2	435	0,22	3	4,6	750
	210	69	2	550	0,32	2,1	3,1	990
	210	69	2	550	0,32	2,1	3,1	990
	225	68	2,1	660	0,28	2,4	3,6	1080
	225	68	2,1	600	0,3	2,3	3,3	990
	225	68	2,1	600	0,3	2,3	3,3	990
	225	68	2,1	600	0,3	2,3	3,3	990



### Spherical Roller Bearings

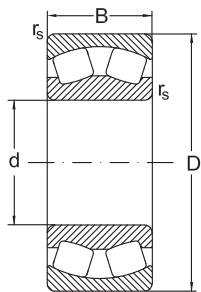

CA

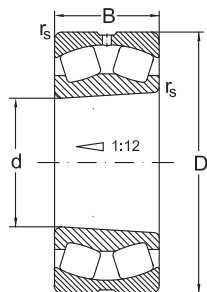

CAKW33

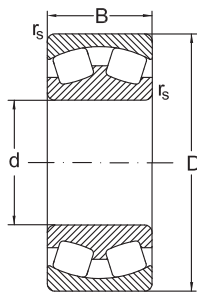

MA

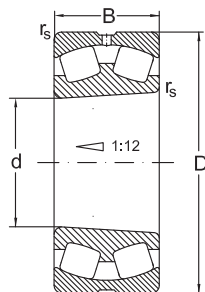

MAKW33

d	y <sub>0</sub>	Speed limit		Designation	Mass
		grease	oil		
mm		min <sup>-1</sup>		Bearing	kg
130	1,9	1100	1500	<b>23226 MBKW33</b>	14,5
	1,8	1200	1600	<b>22326 C</b>	28,82
	1,8	1200	1600	<b>22326 CK</b>	28,65
	1,8	1200	1600	<b>22326 CKW33</b>	28,33
	1,8	1200	1600	<b>22326 CW33</b>	28,45
	1,8	1200	1600	<b>22326 CYW502</b>	28,45
	1,8	1100	1400	<b>22326 MBK</b>	28,77
	1,8	1100	1400	<b>22326 MAC4F80W33</b>	29,48
	1,8	1100	1400	<b>22326 MB</b>	28,9
	1,8	1100	1400	<b>22326 MBW33</b>	28,7
	1,8	1100	1400	<b>22326 MBKW33</b>	28,4
140	2,8	1700	2200	<b>23028 C</b>	7,20
	2,8	1700	2200	<b>23028 CK</b>	7,03
	2,8	1700	2200	<b>23028 CKW33</b>	6,96
	2,8	1700	2200	<b>23028 CW33</b>	7,13
	2,8	1500	2000	<b>23028 MBK</b>	6,07
	2,8	1500	2000	<b>23028 MB</b>	6,18
	2,8	1500	2000	<b>23028 MBW33</b>	6,08
	2,8	1500	2000	<b>23028 MBKW33</b>	5,98
	2,1	1100	1500	<b>24028 MBW33</b>	9,07
	2,1	1100	1500	<b>24028 MBK30W33</b>	8,66
	2,5	1500	2000	<b>23128 C</b>	11,8
	2,2	1400	1800	<b>23128 MBK</b>	10,38
	2,2	1400	1800	<b>23128 MB</b>	10,72
	2,2	1400	1800	<b>23128 MBW33</b>	10,69



### Spherical Roller Bearings

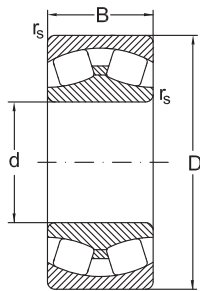

C

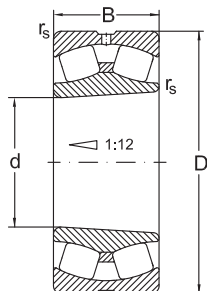

CKW33

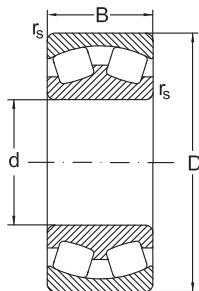

MB

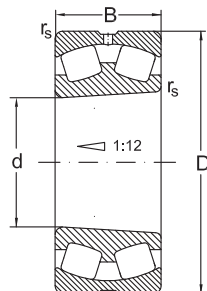

MBKW33

Dimensions				Basic radial load. Factors				
d	D	B	r <sub>s</sub> min.	dyn. C <sub>r</sub>	e	y <sub>1</sub>	y <sub>2</sub>	stat. C <sub>0r</sub>
mm				kN				kN
140	225	68	2,1	600	0,3	2,3	3,3	990
	225	85	2,1	740	0,37	1,8	2,7	1280
	225	85	2,1	740	0,37	1,8	2,7	1280
	225	85	2,1	740	0,37	1,8	2,7	1280
	250	68	3	730	0,26	2,6	3,9	1080
	250	68	3	730	0,26	2,6	3,9	1080
	250	68	3	730	0,26	2,6	3,5	1080
	250	68	3	730	0,26	2,6	3,9	1080
	250	68	3	670	0,29	2,3	3,5	990
	250	68	3	670	0,29	2,3	3,5	990
	250	68	3	670	0,29	2,3	3,5	990
	250	68	3	670	0,29	2,3	3,5	990
	250	88	3	960	0,33	2	3	1500
	250	88	3	880	0,37	1,8	2,7	1380
	250	88	3	880	0,37	1,8	2,7	1380
	250	88	3	880	0,37	1,8	2,7	1380
	250	88	3	880	0,37	1,8	2,7	1380
	300	102	4	1360	0,35	1,9	2,9	1870
	300	102	4	1360	0,35	1,9	2,9	1870
	300	102	4	1360	0,35	1,9	2,9	1870
300	102	4	1360	0,35	1,9	2,9	1870	
300	102	4	1240	0,38	1,7	2,6	1720	
300	102	4	1240	0,38	1,7	2,6	1720	
300	102	4	1240	0,38	1,7	2,6	1720	
300	102	4	1240	0,38	1,7	2,6	1720	

## Spherical Roller Bearings

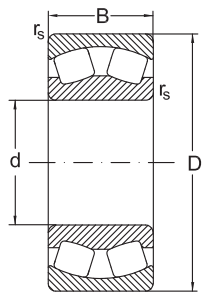

CA

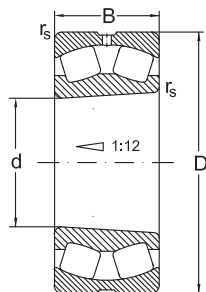

CAKW33

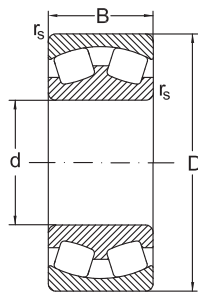

MA

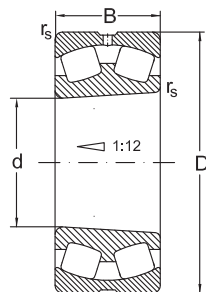

MAKW33

d	y <sub>0</sub>	Speed limit		Designation	Mass
		grease	oil	Bearing	
mm		min <sup>-1</sup>			kg
140	2,2	1400	1800	<b>23128 MBKW33</b>	10,36
	1,8	850	1100	<b>24128 MB</b>	13,27
	1,8	850	1100	<b>24128 MBW33</b>	13,2
	1,8	850	1100	<b>24128 MBK30W33</b>	12,64
	2,5	1400	1900	<b>22228 C</b>	14,4
	2,5	1400	1900	<b>22228 CK</b>	14,09
	2,5	1400	1900	<b>22228 CKW33</b>	13,97
	2,5	1400	1900	<b>22228 CW33</b>	14,27
	2,3	1300	1700	<b>22228 MBK</b>	14,2
	2,3	1300	1700	<b>22228 MB</b>	14,5
	2,3	1300	1700	<b>22228 MBW33</b>	14,27
	2,3	1300	1700	<b>22228 MBKW33</b>	13,97
	2	1100	1400	<b>23228 C</b>	20,86
	1,8	1000	1300	<b>23228 MBK</b>	18,72
	1,8	1000	1300	<b>23228 MB</b>	19,32
	1,8	1000	1300	<b>23228 MBW33</b>	19,19
	1,8	1000	1300	<b>23228 MBKW33</b>	18,59
	1,8	1100	1400	<b>22328 C</b>	36,9
	1,8	1100	1400	<b>22328 CK</b>	36,34
	1,8	1100	1400	<b>22328 CKW33</b>	36,13
	1,8	1100	1400	<b>22328 CW33</b>	36,79
	1,7	1000	1300	<b>22328 MBK</b>	34,57
	1,7	1000	1300	<b>22328 MAC4F80W33</b>	37,5
1,7	1000	1300	<b>22328 MB</b>	35,77	
1,7	1000	1300	<b>22328 MBW33</b>	35,17	



### Spherical Roller Bearings

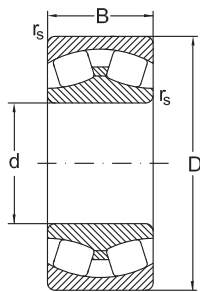

C

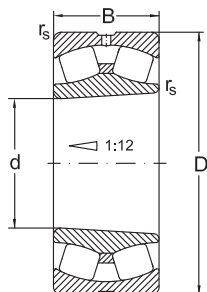

CKW33

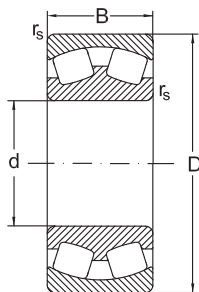

MB

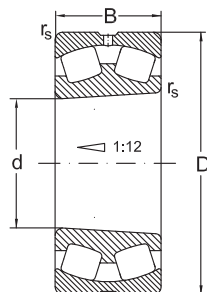

MBKW33

Dimensions				Basic radial load. Factors				
d	D	B	r <sub>s</sub> min.	dyn. C <sub>r</sub>	e	y <sub>1</sub>	y <sub>2</sub>	stat. C <sub>0r</sub>
mm				kN				kN
<b>140</b>	300	102	4	1240	0,38	1,7	2,6	1720
	300	118	4	1200	0,43	1,6	2,3	1700
<b>150</b>	225	56	2,1	520	0,22	3	4,6	900
	225	56	2,1	520	0,22	3	4,6	900
	225	56	2,1	520	0,22	3	4,6	900
	225	56	2,1	520	0,22	3	4,6	900
	225	56	2,1	480	0,22	3	4,6	830
	225	56	2,1	480	0,22	3	4,6	830
	225	56	2,1	480	0,22	3	4,6	830
	225	56	2,1	480	0,22	3	4,6	830
	225	75	2,1	620	0,37	1,8	2,7	1140
	225	75	2,1	600	0,33	2,1	3,1	1080
	225	75	2,1	600	0,33	2,1	3,1	1080
	225	75	2,1	600	0,33	2,1	3,1	1080
	225	75	2,1	600	0,33	2,1	3,1	1080
	250	100	2,1	1080	0,37	1,8	2,7	1840
	250	100	2,1	990	0,4	1,7	2,5	1600
	250	100	2,1	990	0,4	1,7	2,5	1600
	250	100	2,1	990	0,4	1,7	2,5	1600
	250	100	2,1	990	0,4	1,7	2,5	1600
	250	100	2,1	818	0,4	2,1	2,5	1357
	250	80	2,1	800	0,32	2,1	3,2	1320
250	80	2,1	800	0,32	2,1	3,2	1320	
250	80	2,1	800	0,32	2,1	3,2	1320	
250	80	2,1	800	0,32	2,1	3,2	1320	

## Spherical Roller Bearings

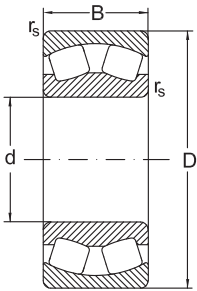

CA

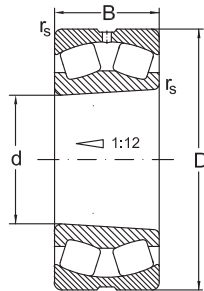

CAKW33

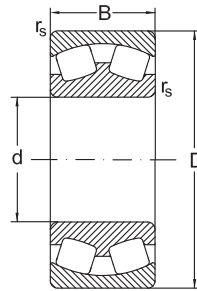

MA

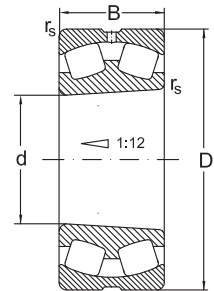

MAKW33

d	y <sub>0</sub>	Speed limit		Designation	Mass
		grease	oil		
mm		min <sup>-1</sup>		Bearing	kg
140	1,7	1000	1300	<b>22328 MBKW33</b>	34,37
	1,5	1100	1500	<b>23328 MAC4F80W33</b>	42,23
150	2,8	1500	2000	<b>23030 C</b>	8,57
	2,8	1500	2000	<b>23030 CK</b>	8,4
	2,8	1500	2000	<b>23030 CKW33</b>	8,32
	2,8	1500	2000	<b>23030 CW33</b>	8,51
	2,8	1400	1800	<b>23030 MBK</b>	8,05
	2,8	1400	1800	<b>23030 MB</b>	8,15
	2,8	1400	1800	<b>23030 MBW33</b>	8,11
	2,8	1400	1800	<b>23030 MBKW33</b>	7,9
	2,1	1200	1600	<b>24030 C</b>	10,5
	2	1100	1400	<b>24030 MBK30</b>	10,1
	2	1100	1400	<b>24030 MB</b>	10,25
	2	1100	1400	<b>24030 MBW33</b>	10,14
	2	1100	1400	<b>24030 MBK30W33</b>	9,97
	1,8	850	1100	<b>24130 C</b>	19,4
	1,6	800	1000	<b>24130 CA</b>	19,66
	1,6	800	1000	<b>24130 CAK30</b>	18,9
	1,6	800	1000	<b>24130 CAW33</b>	19,5
	1,6	800	1000	<b>24130 CAK30W33</b>	18,76
1,6	800	1000	<b>24130 MBW33</b>	19,97	
2,1	1300	1700	<b>23130 MBK</b>	16	
2,1	1300	1700	<b>23130 MB</b>	16,37	
2,1	1300	1700	<b>23130 MBW33</b>	16,24	
2,1	1300	1700	<b>23130 MBKW33</b>	16	



### Spherical Roller Bearings

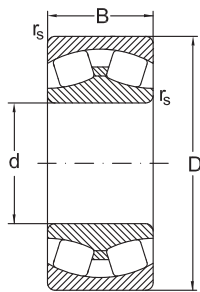

C

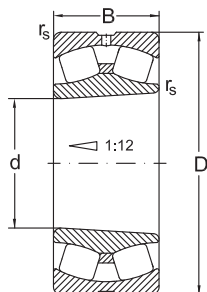

CKW33

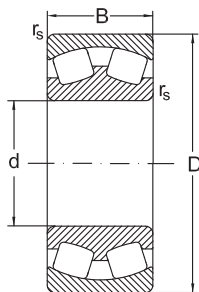

MB

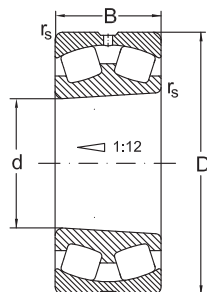

MBKW33

Dimensions				Basic radial load. Factors				
d	D	B	r <sub>s</sub> min.	dyn. C <sub>r</sub>	e	y <sub>1</sub>	y <sub>2</sub>	stat. C <sub>0r</sub>
mm				kN				kN
150	270	73	3	880	0,26	2,6	3,9	1300
	270	73	3	880	0,26	2,6	3,9	1300
	270	73	3	880	0,26	2,6	3,9	1300
	270	73	3	880	0,26	2,6	3,9	1300
	270	73	3	810	0,29	2,3	3,5	1190
	270	73	3	810	0,29	2,3	3,5	1190
	270	73	3	810	0,29	2,3	3,5	1190
	270	73	3	810	0,29	2,3	3,5	1190
	270	96	3	1090	0,4	2,1	2,5	1750
	270	96	3	1030	0,38	1,8	2,7	1610
	270	96	3	1030	0,38	1,8	2,7	1610
	270	96	3	1030	0,38	1,8	2,7	1610
	270	96	3	1030	0,38	1,8	2,7	1610
	320	108	4	1520	0,35	1,9	2,9	2110
	320	108	4	1520	0,35	1,9	2,9	2110
	320	108	4	1520	0,35	1,9	2,9	2110
	320	108	4	1520	0,35	1,9	2,9	2110
	320	108	4	1400	0,38	1,7	2,6	1940
	320	108	4	1400	0,38	1,7	2,6	1940
	320	108	4	1400	0,38	1,7	2,6	1940
320	108	4	1400	0,38	1,7	2,6	1940	
320	108	4	1400	0,38	1,7	2,6	1940	
160	240	60	2,1	610	0,22	3	4,6	1060
	240	60	2,1	610	0,22	3	4,6	1060

## Spherical Roller Bearings

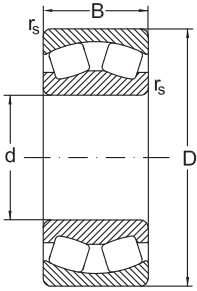

CA

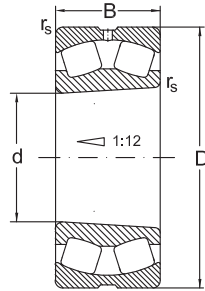

CAKW33

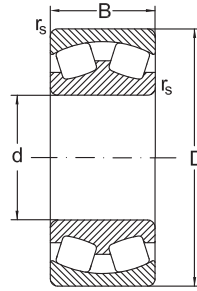

MA

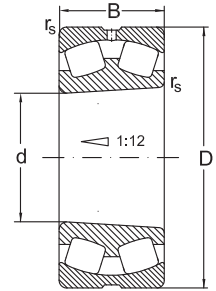

MAKW33

d	$y_0$	Speed limit		Designation	Mass
		grease	oil		
mm		min <sup>-1</sup>		Bearing	kg
150	2,5	1400	1800	<b>22230 C</b>	18,30
	2,5	1400	1800	<b>22230 CK</b>	18,23
	2,5	1400	1800	<b>22230 CKW33</b>	16,99
	2,5	1400	1800	<b>22230 CW33</b>	18,07
	2,3	1200	1600	<b>22230 MBK</b>	17,6
	2,3	1200	1600	<b>22230 MB</b>	18,24
	2,3	1200	1600	<b>22230 MBW33</b>	18,02
	2,3	1200	1600	<b>22230 MBKW33</b>	17,62
	1,8	1100	1400	<b>23230 C</b>	24,7
	1,7	1000	1300	<b>23230 MBK</b>	24,13
	1,7	1000	1300	<b>23230 MB</b>	24,7
	1,7	1000	1300	<b>23230 MBW33</b>	24,58
	1,7	1000	1300	<b>23230 MBKW33</b>	24,0
	1,8	1100	1400	<b>22330 C</b>	44,62
	1,8	1100	1400	<b>22330 CK</b>	43,87
	1,8	1100	1400	<b>22330 CKW33</b>	43,47
	1,8	1100	1400	<b>22330 CW33</b>	44,6
	1,7	1000	1300	<b>22330 MAK4F80W33</b>	44,3
	1,7	1000	1300	<b>22330 MBK</b>	41,35
	1,7	1000	1300	<b>22330 MAC4F80W33</b>	44,4
1,7	1000	1300	<b>22330 MB</b>	42,25	
1,7	1000	1300	<b>22330 MBW33</b>	41,85	
1,7	1000	1300	<b>22330 MBKW33</b>	40,95	
160	2,8	1400	1900	<b>23032 C</b>	9,97
	2,8	1400	1900	<b>23032 CK</b>	9,71



### Spherical Roller Bearings

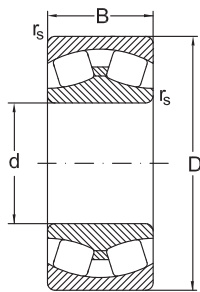

C

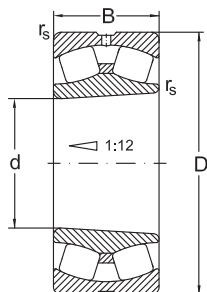

CKW33

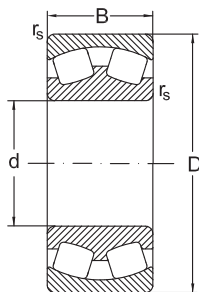

MB

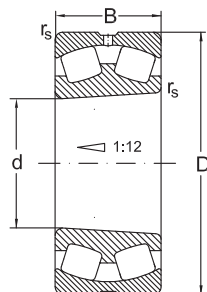

MBKW33

Dimensions				Basic radial load. Factors				
d	D	B	r <sub>s</sub> min.	dyn. C <sub>r</sub>	e	y <sub>1</sub>	y <sub>2</sub>	stat. C <sub>0r</sub>
mm				kN				kN
160	240	60	2,1	610	0,22	3	4,6	1060
	240	60	2,1	610	0,22	3	4,6	1060
	240	60	2,1	560	0,22	3	4,6	970
	240	60	2,1	560	0,22	3	4,6	970
	240	60	2,1	560	0,22	3	4,6	970
	240	60	2,1	560	0,22	3	4,6	970
	240	60	2,1	560	0,22	3	4,6	970
	240	80	2,1	720	0,38	1,7	2,6	1320
	240	80	2,1	650	0,32	2,1	3,1	1170
	240	80	2,1	650	0,32	2,1	3,1	1170
	240	80	2,1	650	0,32	2,1	3,1	1170
	270	109	2,1	1250	0,39	1,7	2,5	2110
	270	109	2,1	1250	0,39	1,7	2,5	2110
	270	109	2,1	1250	0,39	1,7	2,5	2110
	270	109	2,1	1250	0,39	1,7	2,5	2110
	270	109	2,1	1250	0,39	1,7	2,5	2110
	270	109	2,1	1250	0,39	1,7	2,5	2110
	270	109	2,1	940	0,41	1,6	2,4	1558
	270	86	2,1	1010	0,3	2,3	3,4	1640
	270	86	2,1	930	0,32	2,1	3,2	1510
270	86	2,1	930	0,32	2,1	3,2	1510	
270	86	2,1	930	0,32	2,1	3,2	1510	
270	86	2,1	930	0,32	2,1	3,2	1510	
290	104	3	1210	0,3	2,3	3,4	1900	
290	104	3	1180	0,38	1,8	2,7	1830	
290	104	3	1180	0,38	1,8	2,7	1830	





### Spherical Roller Bearings

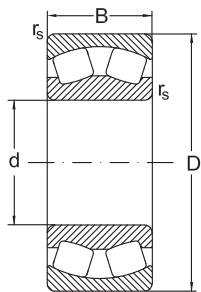

CA

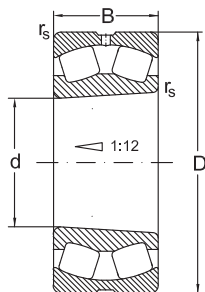

CAKW33

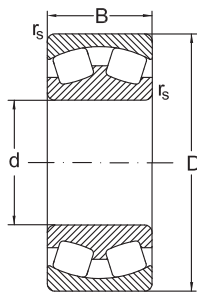

MA

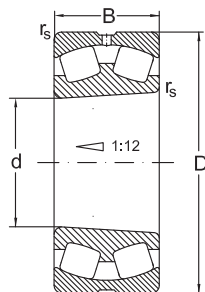

MAKW33

d	y <sub>0</sub>	Speed limit		Designation	Mass
		grease	oil		
mm		min <sup>-1</sup>		Bearing	kg
160	2,8	1400	1900	<b>23032 CKW33</b>	9,56
	2,8	1400	1900	<b>23032 CW33</b>	9,80
	2,8	1300	1700	<b>23032 MBK</b>	10,45
	2,8	1300	1700	<b>23032 MB</b>	10,61
	2,8	1300	1700	<b>23032 MBW33</b>	10,49
	2,8	1300	1700	<b>23032 MBKW33</b>	10,33
	2,1	1100	1400	<b>24032 C</b>	13
	2	1000	1300	<b>24032 MB</b>	12,7
	2	1000	1300	<b>24032 MBW33</b>	12,28
	2	1000	1300	<b>24032 MBK30W33</b>	12,08
	1,6	850	1100	<b>24132 C</b>	25,04
	1,6	850	1100	<b>24132 CW33</b>	24,96
	1,6	850	1100	<b>24132 CK30</b>	24,8
	1,6	850	1100	<b>24132 CK30W33</b>	24,6
	1,6	850	1100	<b>24132 CYK30W33</b>	24,6
	1,6	850	1100	<b>24132 CYW33</b>	24,96
	1,6	750	1100	<b>24132 MBW33</b>	25,38
	2,2	1400	1800	<b>23132 C</b>	22,9
	2,1	1200	1600	<b>23132 MBK</b>	20,7
	2,1	1200	1600	<b>23132 MB</b>	20,95
2,1	1200	1600	<b>23132 MBW33</b>	20,81	
2,1	1200	1600	<b>23132 MBKW33</b>	20,1	
2,2	1000	1400	<b>23232 C</b>	32,7	
1,7	900	1200	<b>23232 MBK</b>	31,7	
1,7	900	1200	<b>23232 MB</b>	32,4	



### Spherical Roller Bearings

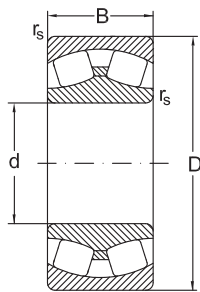

C

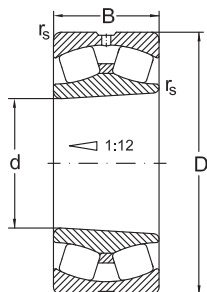

CKW33

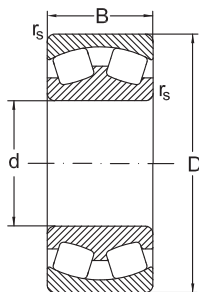

MB

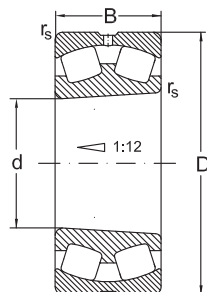

MBKW33

Dimensions				Basic radial load. Factors				
d	D	B	r <sub>s</sub> min.	dyn. C <sub>r</sub>	e	y <sub>1</sub>	y <sub>2</sub>	stat. C <sub>0r</sub>
mm				kN				kN
160	290	104	3	1180	0,38	1,8	2,7	1830
	290	104	3	1180	0,38	1,8	2,7	1830
	290	80	3	1040	0,26	2,6	3,9	1550
	290	80	3	1040	0,26	2,6	3,9	1550
	290	80	3	1040	0,26	2,6	3,9	1550
	290	80	3	1040	0,26	2,6	3,9	1550
	290	80	3	950	0,29	2,3	3,4	1420
	290	80	3	950	0,29	2,3	3,4	1420
	290	80	3	950	0,29	2,3	3,4	1420
	290	80	3	950	0,29	2,3	3,4	1420
	340	114	4	1660	0,35	1,9	2,9	2350
	340	114	4	1660	0,35	1,9	2,9	2350
	340	114	4	1660	0,35	1,9	2,9	2350
	340	114	4	1660	0,35	1,9	2,9	2350
	340	114	4	1520	0,37	1,8	2,7	2160
	340	114	4	1520	0,37	1,8	2,7	2160
	340	114	4	1520	0,37	1,8	2,7	2160
	340	114	4	1520	0,37	1,8	2,7	2160
	340	114	4	1520	0,37	1,8	2,7	2160
	340	114	4	1520	0,37	1,8	2,7	2160
340	136	4	1540	0,44	1,5	2,3	2200	
170	260	67	2,1	750	0,23	2,9	4,4	1270
	260	67	2,1	750	0,23	2,9	4,4	1270

## Spherical Roller Bearings

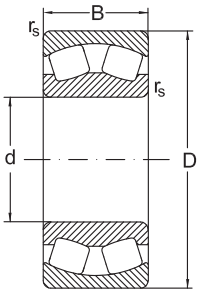

CA

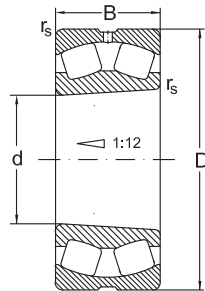

CAKW33

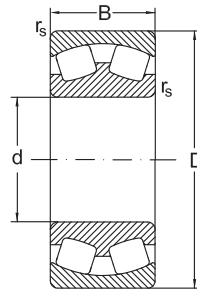

MA

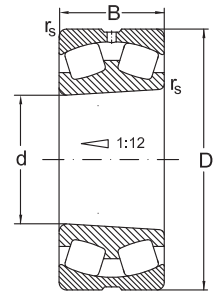

MAKW33

d	$y_0$	Speed limit		Designation	Mass
		grease	oil		
mm		min <sup>-1</sup>		Bearing	kg
160	1,7	900	1200	<b>23232 MBW33</b>	32,1
	1,7	900	1200	<b>23232 MBKW33</b>	31,2
	2,5	1300	1700	<b>22232 C</b>	25,1
	2,5	1300	1700	<b>22232 CK</b>	24,7
	2,5	1300	1700	<b>22232 CKW33</b>	24,6
	2,5	1300	1700	<b>22232 CW33</b>	24,85
	2,3	1100	1500	<b>22232 MBK</b>	22,27
	2,3	1100	1500	<b>22232 MB</b>	23,3
	2,3	1100	1500	<b>22232 MBW33</b>	22,53
	2,3	1100	1500	<b>22232 MBKW33</b>	22,03
	1,8	1000	1300	<b>22332 C</b>	52,5
	1,8	1000	1300	<b>22332 CK</b>	52,16
	1,8	1000	1300	<b>22332 CKW33</b>	51,74
	1,8	1000	1300	<b>22332 CW33</b>	52,7
	1,8	900	1200	<b>22332 MBK</b>	49,16
	1,8	900	1200	<b>22332 MAC4F80W33</b>	50,08
	1,8	900	1200	<b>22332 MAC4W502</b>	50,0
	1,8	900	1200	<b>22332 MAW33</b>	50,08
	1,8	900	1200	<b>22332 MAW502</b>	50,0
	1,8	900	1200	<b>22332 MB</b>	50,26
1,8	900	1200	<b>22332 MBW33</b>	49,84	
1,8	900	1200	<b>22332 MBKW33</b>	48,74	
1,5	1000	1400	<b>23332 MAC4F80W33</b>	61,85	
170	2,8	1400	1800	<b>23034 C</b>	14,23
	2,8	1400	1800	<b>23034 CK</b>	13,95



### Spherical Roller Bearings

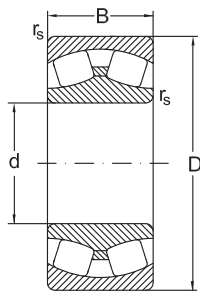

C

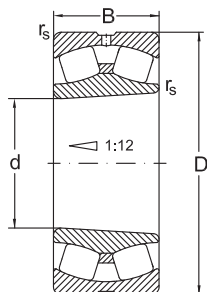

CKW33

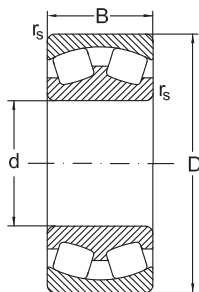

MB

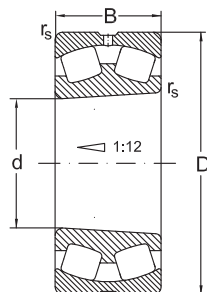

MBKW33

Dimensions				Basic radial load. Factors				
d	D	B	r <sub>s</sub> min.	dyn. C <sub>r</sub>	e	y <sub>1</sub>	y <sub>2</sub>	stat. C <sub>0r</sub>
mm				kN				kN
170	260	67	2,1	750	0,23	2,9	4,4	1270
	260	67	2,1	750	0,23	2,9	4,4	1270
	260	67	2,1	680	0,23	2,9	4,4	1170
	260	67	2,1	680	0,23	2,9	4,4	1170
	260	67	2,1	680	0,23	2,9	4,4	1170
	260	67	2,1	680	0,23	2,9	4,4	1170
	260	90	2,1	880	0,34	2	3	1610
	260	90	2,1	880	0,34	2	3	1610
	260	90	2,1	880	0,34	2	3	1610
	260	90	2,1	880	0,34	2	3	1610
	280	109	2,1	1310	0,37	1,8	2,7	2300
	280	109	2,1	1280	0,39	1,7	2,6	2230
	280	109	2,1	1280	0,39	1,7	2,6	2230
	280	109	2,1	1280	0,39	1,7	2,6	2230
	280	109	2,1	1280	0,39	1,7	2,6	2230
	280	109	2,1	1029	0,37	1,8	2,7	1672
	280	109	2,1	1029	0,37	1,8	2,7	1672
	280	88	2,1	1280	0,37	1,8	2,7	2230
	280	88	2,1	990	0,31	2,2	3,2	1650
	280	88	2,1	990	0,31	2,2	3,2	1650
280	88	2,1	990	0,31	2,2	3,2	1650	
280	88	2,1	990	0,31	2,2	3,2	1650	
310	110	4	1460	0,35	1,9	2,9	2320	
310	110	4	1460	0,35	1,9	2,9	2320	
310	110	4	1460	0,35	1,9	2,9	2320	



### Spherical Roller Bearings

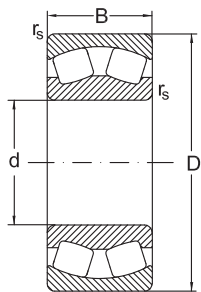

CA

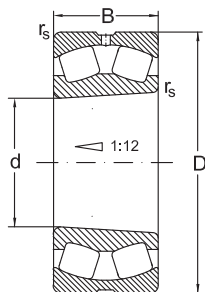

CAKW33

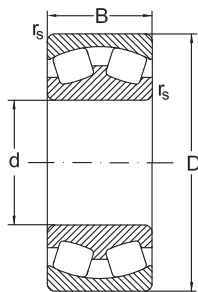

MA

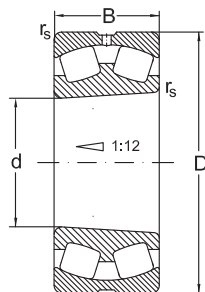

MAKW33

d	y <sub>0</sub>	Speed limit		Designation	Mass
		grease	oil		
mm		min <sup>-1</sup>		Bearing	kg
170	2,8	1400	1800	<b>23034 CKW33</b>	13,78
	2,8	1400	1800	<b>23034 CW33</b>	14,2
	2,8	1200	1600	<b>23034 MBK</b>	14,3
	2,8	1200	1600	<b>23034 MB</b>	14,5
	2,8	1200	1600	<b>23034 MBW33</b>	14,18
	2,8	1200	1600	<b>23034 MBKW33</b>	14,08
	2	1000	1300	<b>24034 MBK30</b>	17,3
	2	1000	1300	<b>24034 MB</b>	17,57
	2	1000	1300	<b>24034 MBW33</b>	16,88
	2	1000	1300	<b>24034 MBK30W33</b>	16,65
	1,8	850	1100	<b>24134 C</b>	27,3
	1,7	750	1000	<b>24134 CA</b>	27,7
	1,7	750	1000	<b>24134 CAW33</b>	27,47
	1,7	750	1000	<b>24134 CAK30</b>	27,41
	1,7	750	1000	<b>24134 CAK30W33</b>	27,3
	1,8	650	800	<b>24134 MBK30W33</b>	27,94
	1,8	650	800	<b>24134 MBW33</b>	28,4
	1,8	1300	1700	<b>23134 C</b>	27,3
	2,1	1100	1500	<b>23134 MBK</b>	21,46
	2,1	1100	1500	<b>23134 MB</b>	21,65
2,1	1100	1500	<b>23134 MBW33</b>	21,5	
2,1	1100	1500	<b>23134 MBKW33</b>	21,2	
1,8	900	1200	<b>23234 CA</b>	37,25	
1,8	900	1200	<b>23234 CAK</b>	36,25	
1,8	900	1200	<b>23234 CAKW33</b>	36,1	



### Spherical Roller Bearings

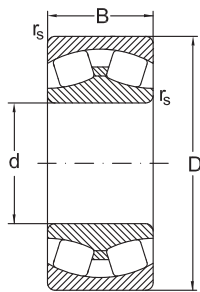

C

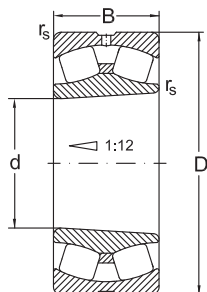

CKW33

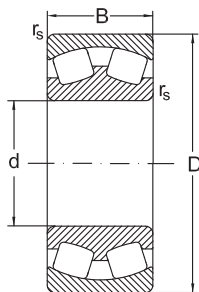

MB

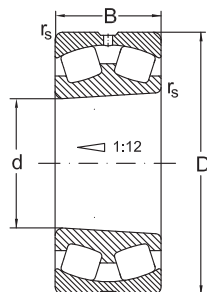

MBKW33

Dimensions				Basic radial load. Factors				
d	D	B	r <sub>s</sub> min.	dyn. C <sub>r</sub>	e	y <sub>1</sub>	y <sub>2</sub>	stat. C <sub>0r</sub>
mm				kN				kN
170	310	110	4	1460	0,35	1,9	2,9	2320
	310	110	4	1500	0,35	1,9	2,9	2350
	310	110	4	1500	0,35	1,9	2,9	2350
	310	110	4	1500	0,35	1,9	2,9	2350
	310	110	4	1500	0,35	1,9	2,9	2350
	310	110	4	1340	0,36	1,9	2,8	2120
	310	110	4	1340	0,36	1,9	2,8	2120
	310	86	4	1170	0,27	2,5	3,7	1750
	310	86	4	1170	0,27	2,5	3,7	1750
	310	86	4	1170	0,27	2,5	3,7	1750
	310	86	4	1170	0,27	2,5	3,7	1750
	310	86	4	1080	0,3	2,3	3,4	1610
	310	86	4	1080	0,3	2,3	3,4	1610
	310	86	4	1080	0,3	2,3	3,4	1610
	310	86	4	1080	0,3	2,3	3,4	1610
	360	120	4	1850	0,33	2	3	2590
	360	120	4	1850	0,33	2	3	2590
	360	120	4	1850	0,33	2	3	2590
	360	120	4	1850	0,33	2	3	2590
	360	120	4	1690	0,37	1,8	2,7	2380
360	120	4	1690	0,37	1,8	2,7	2380	
360	120	4	1690	0,37	1,8	2,7	2380	
360	120	4	1690	0,37	1,8	2,7	2380	
180	250	52	2	454	0,2	3,5	5,2	830

## Spherical Roller Bearings

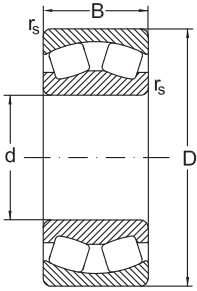

CA

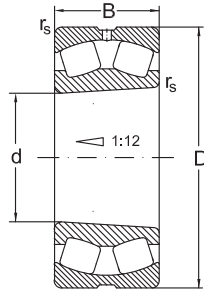

CAKW33

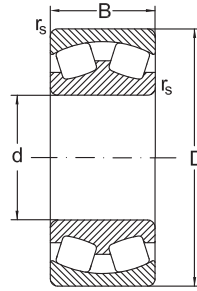

MA

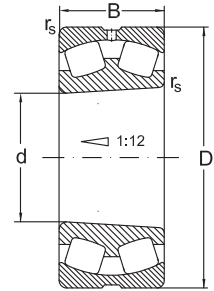

MAKW33

d	$y_0$	Speed limit		Designation	Mass
		grease	oil		
mm		min <sup>-1</sup>		Bearing	kg
170	1,8	900	1200	<b>23234 CAW33</b>	37,17
	1,8	950	1250	<b>23234 C</b>	35,82
	1,8	950	1250	<b>23234 CK</b>	34,75
	1,8	950	1250	<b>23234 CKW33</b>	34,55
	1,8	950	1250	<b>23234 CW33</b>	35,67
	1,8	850	1100	<b>23234 MBW33</b>	35,9
	1,8	850	1100	<b>23234 MBKW33</b>	35,72
	2,5	1200	1600	<b>22234 C</b>	32,2
	2,5	1200	1600	<b>22234 CK</b>	32
	2,5	1200	1600	<b>22234 CKW33</b>	31,66
	2,5	1200	1600	<b>22234 CW33</b>	31,8
	2,2	1300	1100	<b>22234 MBK</b>	29
	2,2	1100	1400	<b>22234 MB</b>	29,4
	2,2	1100	1400	<b>22234 MBW33</b>	29,15
	2,2	1100	1400	<b>22234 MBKW33</b>	27,51
	2	900	1200	<b>22334 C</b>	65,3
	2	900	1200	<b>22334 CK</b>	64
	2	900	1200	<b>22334 CKW33</b>	63,6
	2	900	1200	<b>22334 CW33</b>	64,9
	1,8	850	1100	<b>22334 MBK</b>	57,53
1,8	850	1100	<b>22334 MAC4F80W33</b>	59	
1,8	850	1100	<b>22334 MB</b>	58,83	
1,8	850	1100	<b>22334 MBW33</b>	58,41	
1,8	850	1100	<b>22334 MBKW33</b>	56,7	
180	3,4	1300	1700	<b>23936 MBW33</b>	7,72



### Spherical Roller Bearings

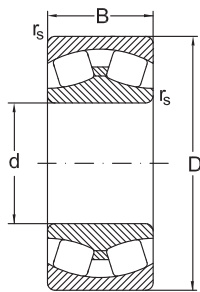

C

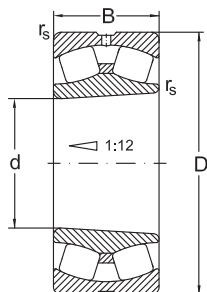

CKW33

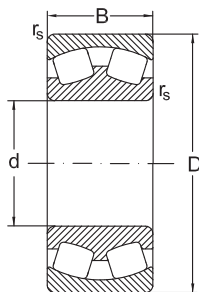

MB

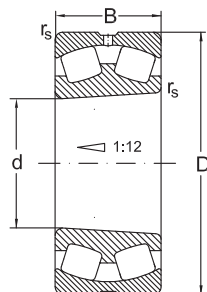

MBKW33

Dimensions				Basic radial load. Factors				
d	D	B	r <sub>s</sub> min.	dyn. C <sub>r</sub>	e	y <sub>1</sub>	y <sub>2</sub>	stat. C <sub>0r</sub>
mm				kN				kN
180	280	100	2,1	1030	0,37	1,8	2,7	1900
	280	100	2,1	900	0,36	1,9	2,8	1750
	280	100	2,1	900	0,36	1,9	2,8	1750
	280	100	2,1	900	0,36	1,9	2,8	1750
	280	74	2,1	870	0,24	2,8	4,2	1500
	280	74	2,1	870	0,24	2,8	4,2	1500
	280	74	2,1	870	0,24	2,8	4,2	1500
	280	74	2,1	870	0,24	2,8	4,2	1500
	280	74	2,1	800	0,24	2,8	4,2	1380
	280	74	2,1	800	0,24	2,8	4,2	1380
	280	74	2,1	800	0,24	2,8	4,2	1380
	280	74	2,1	800	0,24	2,8	4,2	1380
	280	74	2,1	800	0,24	2,8	4,2	1380
	300	118	3	1200	0,4	1,7	2,5	2100
	300	118	3	1400	0,36	1,9	2,8	2560
	300	118	3	1400	0,36	1,9	2,8	2560
	300	118	3	1460	0,4	1,7	2,5	2590
	300	118	3	1460	0,4	1,7	2,5	2590
	300	118	3	1460	0,4	1,7	2,5	2590
	300	118	3	1460	0,4	1,7	2,5	2590
	300	118	3	1460	0,4	1,7	2,5	2590
300	118	3	1460	0,4	1,7	2,5	2590	
300	96	3	1260	0,3	2,3	3,4	2110	
300	96	3	1260	0,3	2,3	3,4	2110	
300	96	3	1260	0,3	2,3	3,4	2110	
300	96	3	1160	0,32	2,1	3,1	1940	
300	96	3	1160	0,32	2,1	3,1	1940	



## Spherical Roller Bearings

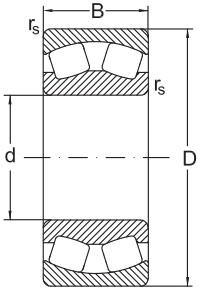

CA

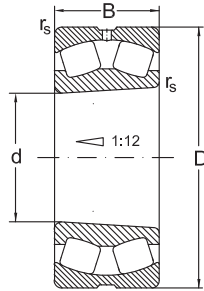

CAKW33

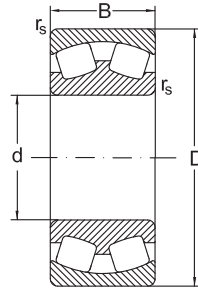

MA

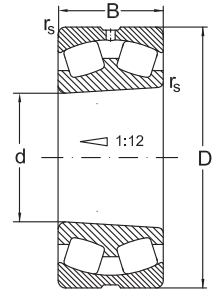

MAKW33

d	$y_0$	Speed limit		Designation	Mass
		grease	oil		
mm		$\text{min}^{-1}$		Bearing	kg
180	1,8	1000	1300	<b>24036 C</b>	23
	1,9	900	1200	<b>24036 MB</b>	22,9
	1,9	900	1200	<b>24036 MBW33</b>	22,79
	1,9	900	1200	<b>24036 MBK30W33</b>	22,42
	2,8	1300	1700	<b>23036 C</b>	18,76
	2,8	1300	1700	<b>23036 CK</b>	18,36
	2,8	1300	1700	<b>23036 CKW33</b>	18,13
	2,8	1300	1700	<b>23036 CW33</b>	18,53
	2,8	1100	1500	<b>23036 MBK</b>	17,2
	2,8	1100	1500	<b>23036 MB</b>	17,7
	2,8	1100	1500	<b>23036 MBW33</b>	17,03
	2,8	1100	1500	<b>23036 MBKW33</b>	16,5
	1,6	600	750	<b>24136 MBK30W33</b>	33,32
	1,9	650	900	<b>24136 CAK30W33</b>	33,42
	1,9	650	900	<b>24136 CAW33</b>	33,96
	1,6	700	950	<b>24136 C</b>	33,52
	1,6	700	950	<b>24136 CW33</b>	33,42
	1,6	700	950	<b>24136 CK30</b>	33,32
	1,6	700	950	<b>24136 CK30W33</b>	33,2
	1,6	700	950	<b>24136 CYW33</b>	33,42
	2,2	1200	1600	<b>23136 C</b>	30,6
2,2	1200	1600	<b>23136 CKW33</b>	29,38	
2,2	1200	1600	<b>23136 CW33</b>	30,25	
2,1	1100	1400	<b>23136 MBK</b>	28	
2,1	1100	1400	<b>23136 MB</b>	28,4	



### Spherical Roller Bearings

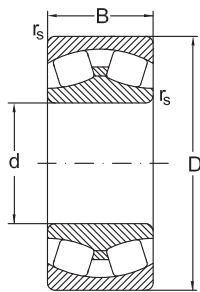

C

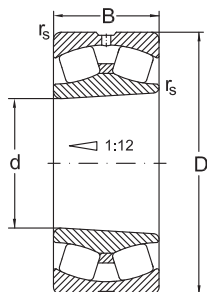

CKW33

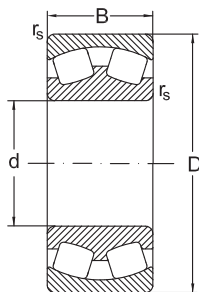

MB

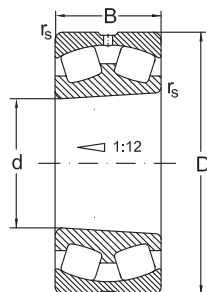

MBKW33

Dimensions				Basic radial load. Factors					
d	D	B	r <sub>s</sub> min.	dyn. C <sub>r</sub>	e	y <sub>1</sub>	y <sub>2</sub>	stat. C <sub>0r</sub>	
mm				kN				kN	
180	300	96	3	1160	0,32	2,1	3,1	1940	
	300	96	3	1160	0,32	2,1	3,1	1940	
	320	112	4	1420	0,36	1,9	2,8	2330	
	320	112	4	1420	0,36	1,9	2,8	2330	
	320	112	4	1420	0,36	1,9	2,8	2330	
	320	86	4	1210	0,26	2,6	3,9	1870	
	320	86	4	1210	0,26	2,6	3,9	1870	
	320	86	4	1210	0,26	2,6	3,9	1870	
	320	86	4	1210	0,26	2,6	3,9	1870	
	320	86	4	1110	0,29	2,3	3,5	1720	
	320	86	4	1110	0,29	2,3	3,5	1720	
	320	86	4	1110	0,29	2,3	3,5	1720	
	320	86	4	1110	0,29	2,3	3,5	1720	
	380	126	4	1960	0,32	2,1	3,1	2650	
	380	126	4	1860	0,37	1,8	2,7	2500	
	380	126	4	1860	0,37	1,8	2,7	2500	
	190	260	52	2	465	0,18	3,7	5,5	900
		260	52	2	465	0,18	3,7	5,5	900
290		75	2,1	915	0,23	3	4,4	1530	
290		75	2,1	915	0,23	3	4,4	1530	
290		100	2,1	1050	0,37	1,8	2,7	1980	
290		100	2,1	980	0,34	2	3	1810	

### Spherical Roller Bearings

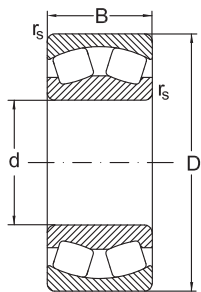

CA

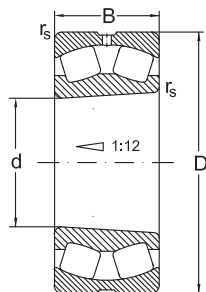

CAKW33

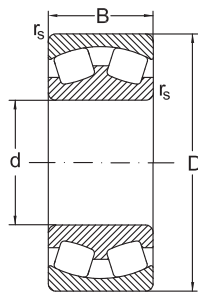

MA

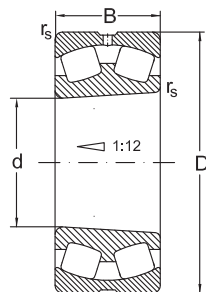

MAKW33

d	y <sub>0</sub>	Speed limit		Designation	Mass
		grease	oil		
mm		min <sup>-1</sup>		Bearing	kg
180	2,1	1100	1400	<b>23136 MBW33</b>	28,09
	2,1	1100	1400	<b>23136 MBKW33</b>	27,7
	1,8	750	1000	<b>23236 MBK</b>	38,5
	1,8	750	1000	<b>23236 MBW33</b>	39,81
	1,8	750	1000	<b>23236 MBKW33</b>	38,36
	2,5	1100	1500	<b>22236 C</b>	33,13
	2,5	1100	1500	<b>22236 CK</b>	32,58
	2,5	1100	1500	<b>22236 CKW33</b>	32,11
	2,5	1100	1500	<b>22236 CW33</b>	32,66
	2,3	1100	1400	<b>22236 MBK</b>	29
	2,3	1100	1400	<b>22236 MB</b>	29,69
	2,3	1100	1400	<b>22236 MBW33</b>	29,54
	2,3	1100	1400	<b>22236 MBKW33</b>	28,84
	2,1	900	1200	<b>22336C</b>	72,5
	1,8	850	1100	<b>22336 MBK</b>	68
	1,8	850	1100	<b>22336 MAC4F80W33</b>	68,8
	1,8	850	1100	<b>22336 MB</b>	71,2
	1,8	850	1100	<b>22336 MBW33</b>	68,71
1,8	850	1100	<b>22336 MBKW33</b>	66,45	
190	3,6	1100	1500	<b>23938 M</b>	8,46
	3,6	1100	1500	<b>23938 MBK</b>	8,2
	2,9	1300	1700	<b>23038C</b>	16,08
	2,9	1300	1700	<b>23038 CK</b>	15,8
	1,8	950	1200	<b>24038 C</b>	25
	2	850	1100	<b>24038 MB</b>	24,5



### Spherical Roller Bearings

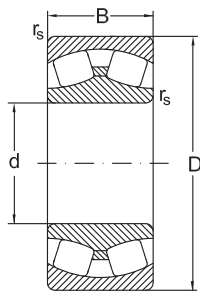

C

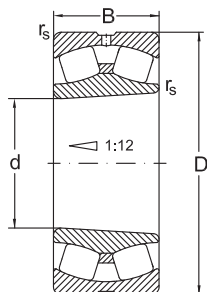

CKW33

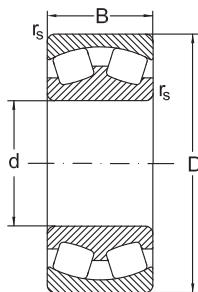

MB

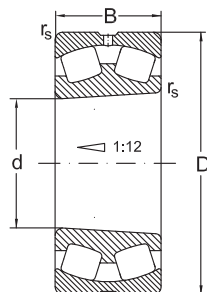

MBKW33

Dimensions				Basic radial load. Factors				
d	D	B	r <sub>s</sub> min.	dyn. C <sub>r</sub>	e	y <sub>1</sub>	y <sub>2</sub>	stat. C <sub>0r</sub>
mm				kN				kN
190	290	100	2,1	980	0,34	2	3	1810
	320	104	3	1320	0,33	2	3	2290
	320	104	3	1320	0,33	2	3	2290
	320	128	3	1540	0,37	1,8	2,7	2750
	320	128	3	1540	0,37	1,8	2,7	2750
	320	128	3	1330	0,35	1,9	2,9	2320
	320	128	3	1330	0,36	1,9	2,9	2320
	340	92	4	1330	0,26	2,6	3,9	2040
	340	92	4	1330	0,26	2,6	3,9	2040
	340	92	4	1220	0,29	2,3	3,4	1870
	340	120	4	1750	0,35	1,9	2,9	2880
	340	120	4	1750	0,35	1,9	2,9	2880
	340	120	4	1610	0,36	1,9	2,8	2640
	400	132	5	1900	0,37	1,8	2,7	2700
400	132	5	1900	0,37	1,8	2,7	2700	
200	280	60	2,1	525	0,2	3,4	5,1	1020
	280	60	2,1	525	0,2	3,4	5,1	1020
	310	82	2,1	1060	0,23	2,9	4,3	1760
	310	82	2,1	1060	0,23	2,9	4,3	1760
	310	109	2,1	1140	0,35	1,9	2,9	2280
	310	109	2,1	1100	0,35	1,9	2,9	2200
	310	109	2,1	1100	0,35	1,9	2,9	2200
	340	112	3	1370	0,35	1,9	2,9	2460
	340	112	3	1370	0,35	1,9	2,9	2460
	340	140	3	1700	0,4	1,6	2,4	3000

## Spherical Roller Bearings

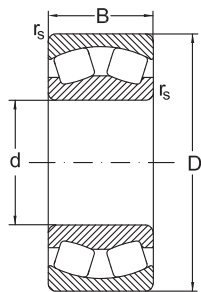

CA

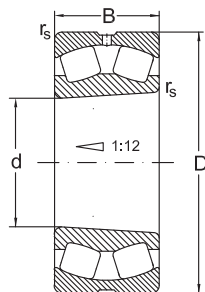

CAKW33

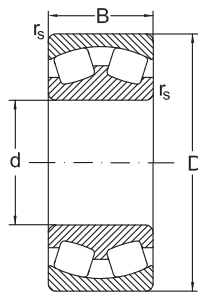

MA

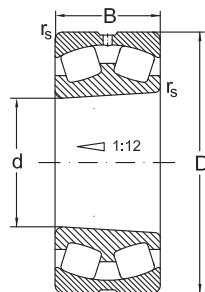

MAKW33

d	y <sub>0</sub>	Speed limit		Designation	Mass
		grease	oil		
mm		min <sup>-1</sup>		Bearing	kg
190	2	850	1100	<b>24038 MBK30</b>	24
	2	1100	1400	<b>23138 MB</b>	36,6
	2	1100	1400	<b>23138 MBK</b>	36,09
	1,8	670	900	<b>24138 CAW33</b>	41,65
	1,8	670	900	<b>24138 CAK30W33</b>	41,4
	1,8	650	850	<b>24138 MBW33</b>	41,79
	1,8	650	850	<b>24138 MBK30W33</b>	41,4
	2,5	1100	1400	<b>22238C</b>	37,2
	2,5	1100	1400	<b>22238CK</b>	36,8
	2,3	1000	1300	<b>22238 MBW33</b>	36,53
	1,8	850	1100	<b>23238C</b>	52,4
	1,8	850	1100	<b>23238CK</b>	52,4
	1,8	750	1000	<b>23238 MBW33</b>	47,83
	1,8	750	1000	<b>22338MB</b>	81,2
1,8	750	1000	<b>22338 MBK</b>	80,5	
200	3,3	1100	1400	<b>23940 MBW33</b>	11,4
	3,3	1100	1400	<b>23940 MBKW33</b>	11
	2,8	1300	1700	<b>23040 CW33</b>	22,4
	2,8	1300	1700	<b>23040 CKW33</b>	21,8
	1,9	850	1100	<b>24040 CW33</b>	31
	1,9	750	1000	<b>24040 MBW33</b>	30,5
	1,9	750	1000	<b>24040 MBK30W33</b>	29,7
	1,9	1100	1400	<b>23140 MBW33</b>	43,5
	1,9	1100	1400	<b>23140 MBKW33</b>	43,5
	1,6	800	1000	<b>24140 CW33</b>	52,5



### Spherical Roller Bearings

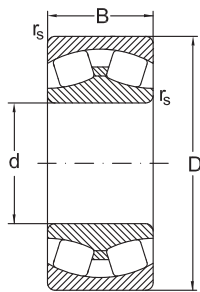

C

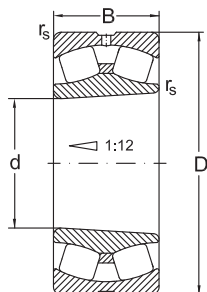

CKW33

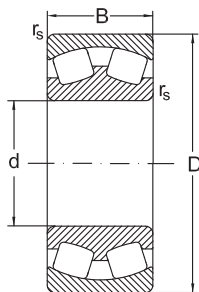

MB

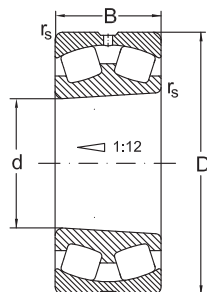

MBKW33

Dimensions				Basic radial load. Factors				
d	D	B	r <sub>s</sub> min.	dyn. C <sub>r</sub>	e	y <sub>1</sub>	y <sub>2</sub>	stat. C <sub>0r</sub>
mm				kN				kN
<b>200</b>	340	140	3	1700	0,14	1,6	2,4	3000
	360	98	4	1250	0,29	2,3	3,9	2020
	360	98	4	1250	0,29	2,3	3,9	2020
	360	128	4	1620	0,35	1,9	2,9	2590
	360	128	4	1620	0,35	1,9	2,9	2590
	420	138	5	1910	0,36	1,8	2,8	2750
	420	138	5	1910	0,36	1,8	2,8	2750
<b>220</b>	300	60	2,1	625	0,18	3,8	5,6	1344
	300	60	2,1	625	0,18	3,8	5,6	1344
	340	90	3	1025	0,26	2,6	3,8	1730
	340	90	3	1025	0,26	2,6	3,8	1730
	340	118	3	1400	0,34	2	2,9	2700
	340	118	3	1400	0,34	2	2,9	2700
	370	150	4	1900	0,41	1,6	2,4	3450
	370	150	4	1900	0,41	1,6	2,4	3450
	370	120	4	1515	0,3	2,3	3,4	2509
	370	120	4	1515	0,3	2,3	3,4	2509
	400	108	4	1545	0,29	2,3	3,4	2300
	400	108	4	1545	0,29	2,3	3,4	2300
	400	144	4	2065	0,35	1,9	2,9	3380
	400	144	4	2065	0,35	1,9	2,9	3380
	460	145	5	2380	0,36	1,8	2,8	3407
460	145	5	2380	0,36	1,8	2,8	3407	
<b>240</b>	320	60	2,1	600	0,17	4,1	6	1170
	320	60	2,1	600	0,17	4,1	6	1170

### Spherical Roller Bearings

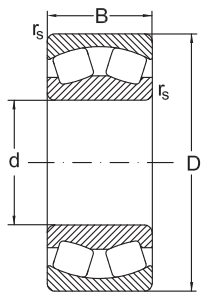

CA

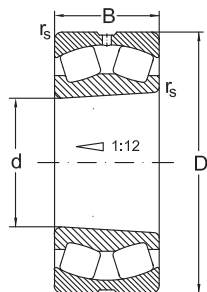

CAKW33

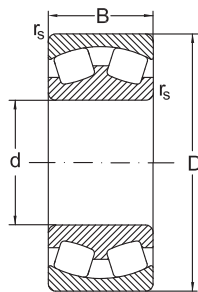

MA

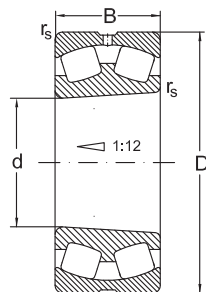

MAKW33

d	y <sub>0</sub>	Speed limit		Designation	Mass
		grease	oil		
mm		min <sup>-1</sup>		Bearing	kg
200	1,6	800	1000	<b>24140 CK30W33</b>	52,5
	2,3	1100	1400	<b>22240 CW33</b>	44,4
	2,3	1100	1400	<b>22240 CKW33</b>	44,4
	1,8	750	1000	<b>23240 CW33</b>	58,4
	1,8	750	1000	<b>23240 CKW33</b>	58,4
	1,8	670	900	<b>22340 MBW33</b>	91,8
	1,8	670	900	<b>22340 MBKW33</b>	91,8
220	3,7	1100	1500	<b>23944 MBW33</b>	13
	3,7	1100	1500	<b>23944 MBKW33</b>	13
	2,5	900	1200	<b>23044 MBW33</b>	31
	2,5	900	1200	<b>23044 MBKW33</b>	31
	1,9	750	1000	<b>24044 MBW33</b>	39,5
	1,9	750	1000	<b>24044 MBK30W33</b>	39,5
	1,6	700	900	<b>24144 MBW33</b>	65,5
	1,6	700	900	<b>24144 MBK30W33</b>	65,5
	2,2	1000	1300	<b>23144 MBKW33</b>	52
	2,2	1000	1300	<b>23144 MBW33</b>	52
	2,3	900	1200	<b>22244 CW33</b>	61,4
	2,3	900	1200	<b>22244 CKW33</b>	61,4
	1,8	670	900	<b>23244 CW33</b>	79,5
	1,8	670	900	<b>23244 CKW33</b>	79,5
	1,8	700	950	<b>22344 CW33</b>	120
1,8	700	950	<b>22344 CKW33</b>	120	
240	4	1000	1300	<b>23948 MBKW33</b>	14
	4	1000	1300	<b>23948 MBW33</b>	14



### Spherical Roller Bearings

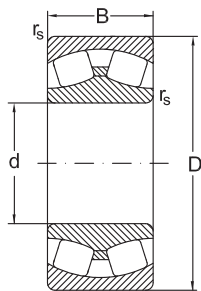

C

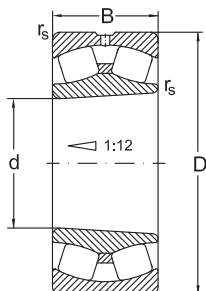

CKW33

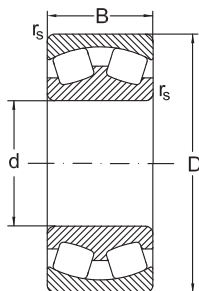

MB

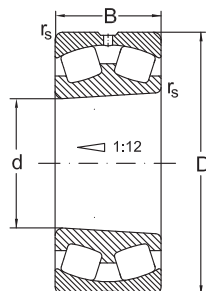

MBKW33

Dimensions				Basic radial load. Factors				
d	D	B	r <sub>s</sub> min.	dyn. C <sub>r</sub>	e	y <sub>1</sub>	y <sub>2</sub>	stat. C <sub>0r</sub>
mm				kN				kN
240	360	92	3	1160	0,3	2,3	3,4	2200
	360	92	3	1090	0,25	2,7	4,1	1960
	360	92	3	1090	0,25	2,7	4,1	1960
	360	118	3	1460	0,32	2,1	3,1	2841
	360	118	3	1460	0,32	2,1	3,1	2841
	400	128	4	1705	0,3	2,3	3,4	2863
	400	128	4	1705	0,3	2,3	3,4	2863
	400	160	4	1987	0,41	1,7	2,5	3530
	400	160	4	1987	0,41	1,7	2,5	3530
	440	120	4	1845	0,29	2,3	3,4	2763
	440	120	4	1845	0,29	2,3	3,4	2763
	440	160	4	2530	0,35	1,9	2,9	4600
	440	160	4	2530	0,35	1,9	2,9	4600
	500	155	5	2650	0,31	2,2	3,3	4000
500	155	5	2650	0,31	2,2	3,3	4000	
260	360	75	2,1	845	0,19	3,5	5,3	1604
	360	75	2,1	845	0,19	3,5	5,3	1604
	400	104	4	1500	0,26	2,6	3,9	2800
	400	104	4	1500	0,26	2,6	3,9	2800
	400	140	4	1775	0,35	1,9	2,9	3494
	400	140	4	1775	0,35	1,9	2,9	3494
	440	180	4	2500	0,42	1,6	2,4	5100
	440	180	4	2500	0,42	1,6	2,4	5100
	440	144	4	2153	0,31	2,2	3,3	3673
	440	144	4	2153	0,31	2,2	3,3	3673



## Spherical Roller Bearings

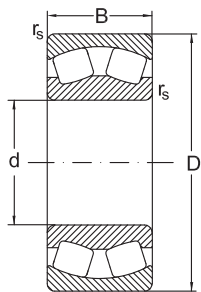

CA

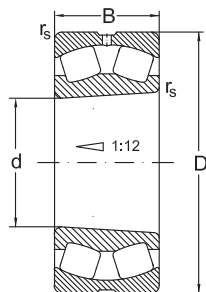

CAKW33

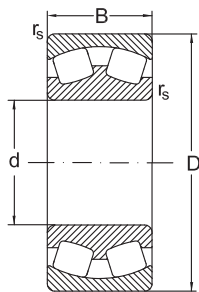

MA

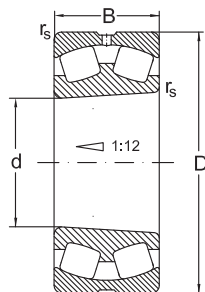

MAKW33

d	$y_0$	Speed limit		Designation	Mass
		grease	oil		
mm		min <sup>-1</sup>		Bearing	kg
240	2,2	900	1100	<b>23048 CW33</b>	34,5
	2,7	800	1000	<b>23048 MBKW33</b>	33,9
	2,7	800	1000	<b>23048 MBW33</b>	33,9
	2,1	750	1000	<b>24048 MBK30W33</b>	42,5
	2,1	750	1000	<b>24048 MBW33</b>	42,5
	2,2	900	1200	<b>23148 MBKW33</b>	66
	2,2	900	1200	<b>23148 MBW33</b>	66
	1,6	530	700	<b>24148 MBW33</b>	79,5
	1,6	530	700	<b>24148 MBK30W33</b>	79,5
	2,3	850	1100	<b>22248 CW33</b>	83,2
	2,3	850	1100	<b>22248 CKW33</b>	83,2
	1,8	630	850	<b>23248 CW33</b>	109
	1,8	630	850	<b>23248 CKW33</b>	109
	2,2	560	750	<b>22348 MBW33</b>	151
2,2	560	750	<b>22348 MBKW33</b>	151	
260	3,5	850	1100	<b>23952 MBKW33</b>	24
	3,5	850	1100	<b>23952 MBW33</b>	24
	2,6	750	950	<b>23052 MBKW33</b>	49
	2,6	750	950	<b>23052 MBW33</b>	49
	1,9	600	800	<b>24052 MBK30W33</b>	66
	1,9	600	800	<b>24052 MBW33</b>	66
	1,6	480	630	<b>24152 MBW33</b>	110
	1,6	480	630	<b>24152 MBK30W33</b>	110
	2,2	850	1100	<b>23152 MBKW33</b>	92,5
	2,2	850	1100	<b>23152 MBW33</b>	92,5



### Spherical Roller Bearings

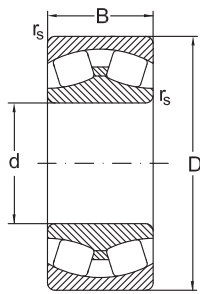

C

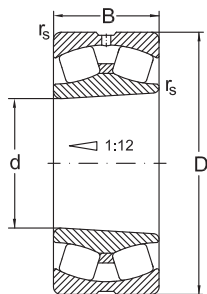

CKW33

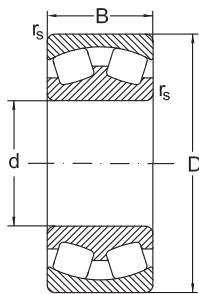

MB

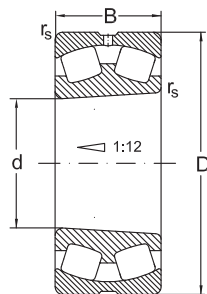

MBKW33

Dimensions				Basic radial load. Factors				
d	D	B	r <sub>s</sub> min.	dyn. C <sub>r</sub>	e	y <sub>1</sub>	y <sub>2</sub>	stat. C <sub>0r</sub>
mm				kN				kN
260	480	130	5	2190	0,29	2,3	3,4	3300
	480	130	5	2190	0,29	2,3	3,4	3300
	540	165	6	3125	0,36	1,8	2,8	4560
	540	165	6	3125	0,36	1,8	2,8	4560
280	380	75	2,1	950	0,18	3,8	5,6	2000
	380	75	2,1	950	0,18	3,8	5,6	2000
	420	106	4	1560	0,25	2,7	4,1	3000
	420	106	4	1560	0,25	2,7	4,1	3000
	420	140	4	2000	0,33	2	3	4000
	420	140	4	2000	0,33	2	3	4000
	460	146	5	2295	0,3	2,3	3,4	4050
	460	146	5	2295	0,3	2,3	3,4	4050
	460	180	5	2635	0,39	1,7	2,5	4848
	460	180	5	2635	0,39	1,7	2,5	4848
	500	130	5	2330	0,29	2,3	3,4	3600
	500	130	5	2330	0,29	2,3	3,4	3600
	500	176	5	2806	0,35	1,9	2,9	4645
	500	176	5	2806	0,35	1,9	2,9	4645
	580	175	6	3530	0,36	1,8	2,8	5208
	580	175	6	3530	0,36	1,8	2,8	5208
300	420	90	3	1175	0,2	3,4	5,1	2261
	420	90	3	1175	0,2	3,4	5,1	2261
	460	118	4	1960	0,25	2,7	4	3650
	460	118	4	1960	0,25	2,7	4	3650
	460	160	4	2385	0,35	2	2,9	4702

## Spherical Roller Bearings

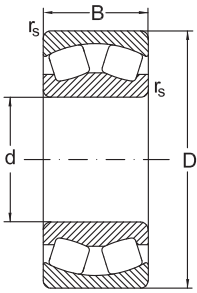

CA

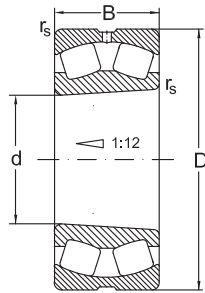

CAKW33

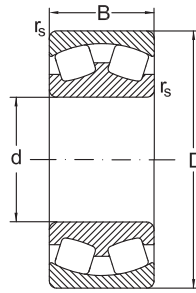

MA

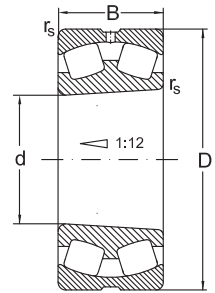

MAKW33

d	$y_0$	Speed limit		Designation	Mass
		grease	oil		
mm		min <sup>-1</sup>		Bearing	kg
260	2,3	750	1000	<b>22252 MBW33</b>	107
	2,3	750	1000	<b>22252 MBKW33</b>	107
	1,8	600	800	<b>22352 CW33</b>	187
	1,8	600	800	<b>22352 CKW33</b>	187
280	3,7	900	1200	<b>23956 MBKW33</b>	26
	3,7	900	1200	<b>23956 MBW33</b>	26
	2,7	700	900	<b>23056 MBKW33</b>	52,5
	2,7	700	900	<b>23056 MBW33</b>	52,5
	2	560	750	<b>24056 MBK30W33</b>	68,5
	2	560	750	<b>24056 MBW33</b>	68,5
	2,2	750	1000	<b>23156 MBKW33</b>	98,5
	2,2	750	1000	<b>23156 MBW33</b>	98,5
	1,7	400	530	<b>24156 MBW33</b>	118
	1,7	400	530	<b>24156 MBK30W33</b>	118
	2,3	700	950	<b>22256 MBW33</b>	113
	2,3	700	950	<b>22256 MBKW33</b>	113
	1,8	480	630	<b>23256 MBW33</b>	153
	1,8	480	630	<b>23256 MBKW33</b>	153
	1,8	560	750	<b>22356 CW33</b>	235
	1,8	560	750	<b>22356 CKW33</b>	235
300	3,3	750	1000	<b>23960 MBKW33</b>	40
	3,3	750	1000	<b>23960 MBW33</b>	40
	2,6	630	800	<b>23060 MBKW33</b>	73,6
	2,6	630	800	<b>23060 MBW33</b>	73,6
	1,9	560	759	<b>24060 MBK30W33</b>	97



### Spherical Roller Bearings

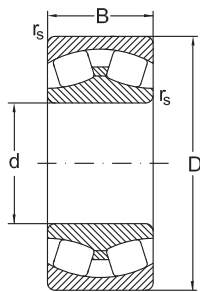

C

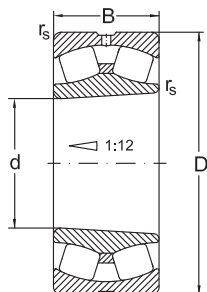

CKW33

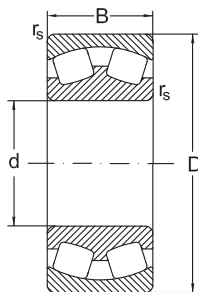

MB

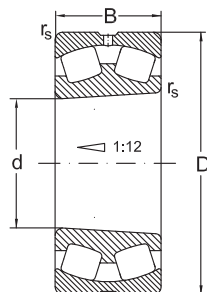

MBKW33

Dimensions				Basic radial load. Factors				
d	D	B	r <sub>s</sub> min.	dyn. C <sub>r</sub>	e	y <sub>1</sub>	y <sub>2</sub>	stat. C <sub>0r</sub>
mm				kN				kN
<b>300</b>	460	160	4	2385	0,35	2	2,9	4702
	500	160	5	2385	0,3	2,3	3,4	4485
	500	160	5	2385	0,3	2,3	3,4	4485
	500	200	5	3213	0,4	1,7	2,5	6011
	500	200	5	3213	0,4	1,7	2,5	6011
	540	140	5	2655	0,29	2,3	3,4	4230
	540	140	5	2655	0,29	2,3	3,4	4230
<b>320</b>	440	90	3	1215	0,19	3,6	5,4	2409
	440	90	3	1215	0,19	3,6	5,4	2409
	480	121	4	2040	0,25	2,7	4,1	4000
	480	121	4	2040	0,25	2,7	4,1	4000
	480	160	4	2500	0,33	2,1	3,1	5240
	480	160	4	2500	0,33	2,1	3,1	5240
	540	176	5	3115	0,34	2	3	6000
	540	176	5	3115	0,34	2	3	6000
	540	218	5	3750	0,41	1,7	2,5	7300
	540	218	5	3750	0,41	1,7	2,5	7300
	580	150	5	2997	0,29	2,5	3,7	4740
	580	150	5	2997	0,29	2,5	3,7	4740
	580	208	5	4130	0,35	1,9	2,9	7026
	580	208	5	4130	0,35	1,9	2,9	7026
<b>340</b>	440	90	3	1306	0,189	3,8	5,7	2691
	440	90	3	1306	0,189	3,8	5,7	2691
	520	133	5	2360	0,25	2,7	4	4500
	520	133	5	2360	0,25	2,7	4	4500

## Spherical Roller Bearings

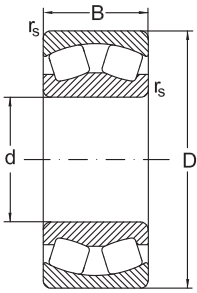

CA

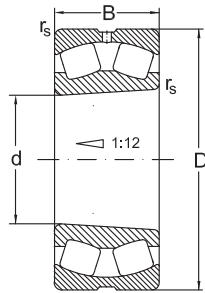

CAKW33

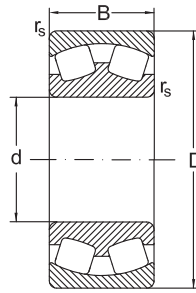

MA

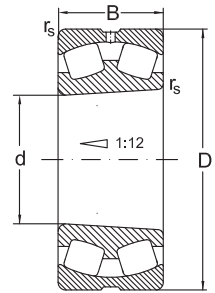

MAKW33

d	$y_0$	Speed limit		Designation	Mass
		grease	oil		
mm		min <sup>-1</sup>		Bearing	kg
300	1,9	560	759	<b>24060 MBW33</b>	97
	2,2	700	950	<b>23160 MBKW33</b>	129
	2,2	700	950	<b>23160 MBW33</b>	129
	1,6	430	560	<b>24160 MBW33</b>	159
	1,6	430	560	<b>24160 MBK30W33</b>	159
	2,3	670	900	<b>22260 CAKW33</b>	142
	2,3	670	900	<b>22260 CAW33</b>	142
320	3,5	670	900	<b>23964 MBKW33</b>	42
	3,5	670	900	<b>23964 MBW33</b>	42
	2,7	600	750	<b>23064 MBKW33</b>	79,5
	2,7	600	750	<b>23064 MBW33</b>	79,5
	2	530	700	<b>24064 MBK30W33</b>	106
	2	530	700	<b>24064 MBW33</b>	106
	1,9	530	670	<b>23164 MBW33</b>	165
	1,9	530	670	<b>23164 MBKW33</b>	165
	1,6	400	530	<b>24164 MBW33</b>	215
	1,6	400	530	<b>24164 MBK30W33</b>	215
	2,5	630	580	<b>22264 CAKW33</b>	180
	2,5	630	580	<b>22264 CAW33</b>	180
	1,8	430	560	<b>23264 MBW33</b>	247
1,8	430	560	<b>23264 MBKW33</b>	247	
340	3,8	630	850	<b>23968 CAKW33</b>	47
	3,8	630	850	<b>23698 CAW33</b>	47,8
	2,6	560	700	<b>23068 CAKW33</b>	101
	2,6	560	700	<b>23068 CAW33</b>	105



### Spherical Roller Bearings

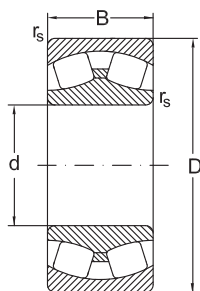

C

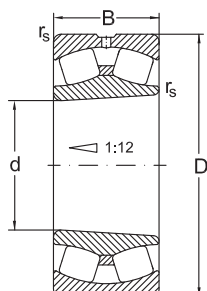

CKW33

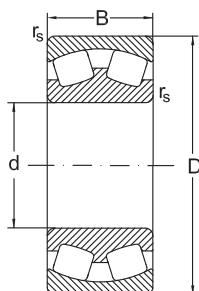

MB

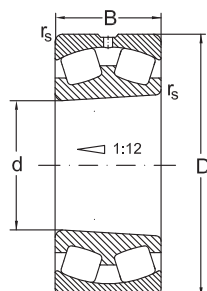

MBKW33

Dimensions				Basic radial load. Factors				
d	D	B	r <sub>s</sub> min.	dyn. C <sub>r</sub>	e	y <sub>1</sub>	y <sub>2</sub>	stat. C <sub>0r</sub>
mm				kN				kN
340	520	180	5	2912	0,34	2	2,9	5961
	520	180	5	2912	0,34	2	2,9	5961
	580	190	5	3740	0,31	2,2	3,2	6640
	580	190	5	3740	0,31	2,2	3,2	6640
	580	243	5	4400	0,43	1,6	2,3	8500
	580	243	5	4400	0,43	1,6	2,3	8500
360	480	90	3	1030	0,17	4,1	6	3200
	480	90	3	1030	0,17	4,1	6	3200
	540	134	5	2450	0,25	2,7	4,1	4800
	540	134	5	2450	0,25	2,7	4,1	4800
	540	180	5	3150	0,33	2,1	3,1	6530
	540	180	5	3150	0,33	2,1	3,1	6530
	600	192	5	3810	0,33	2,3	3,4	7010
	600	192	5	3810	0,33	2,3	3,4	7010
	600	243	5	4500	0,41	1,6	2,4	9000
	600	243	5	4500	0,41	1,6	2,4	9000
	650	232	6	4880	0,35	1,9	2,9	8490
	650	232	6	4880	0,35	1,9	2,9	8490
380	520	106	4	1785	0,19	3,6	5,3	4000
	520	106	4	1785	0,19	3,6	5,3	4000
	560	135	5	2550	0,25	2,8	4,2	5300
	560	135	5	2550	0,25	2,8	4,2	5300
	560	180	5	3150	0,31	2,2	3,2	6710
	560	180	5	3150	0,31	2,2	3,2	6710
	620	194	5	3890	0,3	2,3	3,4	7540

## Spherical Roller Bearings

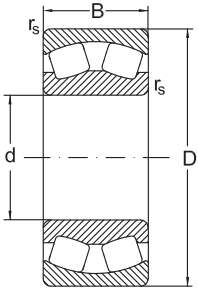

CA

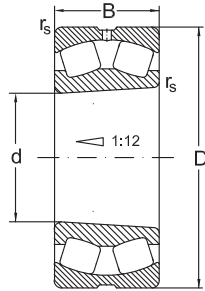

CAKW33

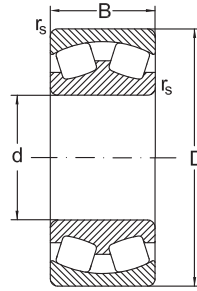

MA

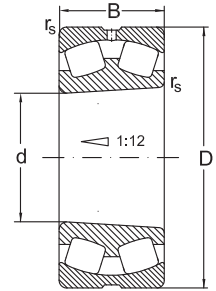

MAKW33

d	y <sub>0</sub>	Speed limit		Designation	Mass
		grease	oil		
mm		min <sup>-1</sup>		Bearing	kg
340	1,9	480	600	<b>24068 CAW33</b>	146
	1,9	480	600	<b>24068 CAK30W33</b>	143
	2,2	630	850	<b>23168 CAW33</b>	215
	2,2	630	850	<b>23168 CAKW33</b>	212
	1,5	450	560	<b>24168 CAW33</b>	266
	1,5	450	560	<b>24168 CAK30W33</b>	260
360	4	560	700	<b>23972 CAKW33</b>	45
	4	560	700	<b>23972 CAW33</b>	46,5
	2,7	530	670	<b>23072 CAKW33</b>	107
	2,7	530	670	<b>23072 CAW33</b>	112
	2	480	630	<b>24072 CAK30W33</b>	136
	2	480	630	<b>24072 CAW33</b>	138
	2,2	600	800	<b>23172 CAKW33</b>	217
	2,2	600	800	<b>23172 CAW33</b>	230
	1,6	430	530	<b>24172 CAW33</b>	279
	1,6	430	530	<b>24172 CAK30W33</b>	275
	1,8	430	560	<b>23272 CAW33</b>	347
	1,8	430	560	<b>23272 CAKW33</b>	328
380	3,5	630	850	<b>23976 CAKW33</b>	66,3
	3,5	630	850	<b>23976 CAW33</b>	68,5
	2,8	500	630	<b>23076 CAKW33</b>	113
	2,8	500	630	<b>23076 CAW33</b>	117
	2,1	450	600	<b>24076 CAK30W33</b>	155
	2,1	450	600	<b>24076 CAW33</b>	158
	2,2	560	750	<b>23176 CAKW33</b>	240



### Spherical Roller Bearings

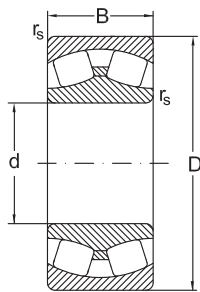

C

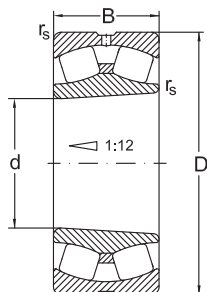

CKW33

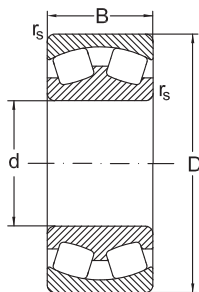

MB

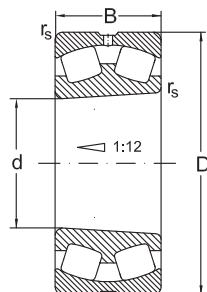

MBKW33

Dimensions				Basic radial load. Factors				
d	D	B	r <sub>s</sub> min.	dyn. C <sub>r</sub>	e	y <sub>1</sub>	y <sub>2</sub>	stat. C <sub>0r</sub>
mm				kN				kN
380	620	194	5	3890	0,3	2,3	3,4	7540
	620	243	5	4650	0,39	1,7	2,5	9500
	620	243	5	4650	0,39	1,7	2,5	9500
	680	240	6	5050	0,35	1,9	2,9	9660
	680	240	6	5050	0,35	1,9	2,9	9660
400	540	106	4	1850	0,18	3,7	5,5	3990
	540	106	4	1850	0,18	3,7	5,5	3990
	600	148	5	3050	0,24	2,8	4,1	6200
	600	148	5	3050	0,24	2,8	4,1	6200
	600	200	5	3610	0,33	2,1	3,1	7545
	600	200	5	3610	0,33	2,1	3,1	7545
	650	200	6	4500	0,28	2,4	3,6	7900
	650	200	6	4500	0,28	2,4	3,6	7900
	650	250	6	5100	0,39	1,7	2,6	10400
	650	250	6	5100	0,39	1,7	2,6	10400
	720	256	6	5950	0,35	1,9	2,9	10807
	720	256	6	5950	0,35	1,9	2,9	10807
420	560	106	4	1960	0,18	3,8	5,7	4130
	560	106	4	1960	0,18	3,8	5,7	4130
	620	150	5	3150	0,24	2,8	4,2	6550
	620	150	5	3150	0,24	2,8	4,2	6550
	620	200	5	4000	0,32	2,1	3,2	8800
	620	200	5	4000	0,32	2,1	3,2	8800
	700	224	6	4600	0,33	2	3	9000
	700	224	6	4600	0,33	2	3	9000



### Spherical Roller Bearings

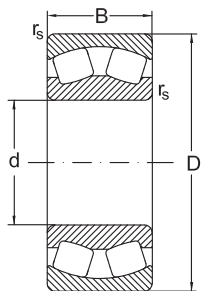

CA

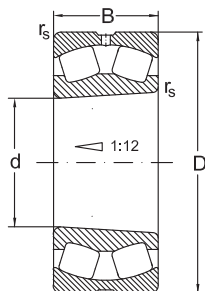

CAKW33

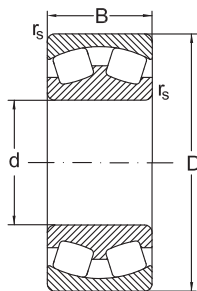

MA

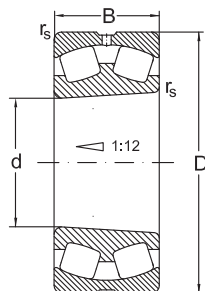

MAKW33

d	y <sub>0</sub>	Speed limit		Designation	Mass
		grease	oil		
mm		min <sup>-1</sup>		Bearing	kg
380	2,2	560	750	<b>23176 CAW33</b>	241
	1,7	400	500	<b>24176 CAW33</b>	279
	1,7	400	500	<b>24176 CAK30W33</b>	277
	1,8	400	530	<b>23276 CAW33</b>	390
	1,8	400	530	<b>23276 CAKW33</b>	367
400	3,6	600	800	<b>23980 CAW33</b>	72,9
	3,6	600	800	<b>23980 CAKW33</b>	68,2
	2,7	450	560	<b>23080 CAKW33</b>	143
	2,7	450	560	<b>23080 CAW33</b>	151
	2	430	460	<b>24080 CAW33</b>	198
	2	430	460	<b>24080 CAK30W33</b>	196
	2,5	530	700	<b>23180 CAKW33</b>	261
	2,5	530	700	<b>23180 CAW33</b>	270
	1,7	380	480	<b>24180 CAW33</b>	326
	1,7	380	480	<b>24180 CAK30W33</b>	312
	1,8	380	500	<b>23280 CAW33</b>	469
	1,8	380	500	<b>23280 CAKW33</b>	442
420	3,8	600	800	<b>23984 CAKW33</b>	78
	3,8	600	800	<b>23984 CAW33</b>	80,5
	2,8	450	560	<b>23084 CAKW33</b>	155
	2,8	450	560	<b>23084 CAW33</b>	162
	2,1	380	480	<b>24084 CAK30W33</b>	214
	2,1	380	480	<b>24084 CAW33</b>	217
	2	500	670	<b>23184 CAW33</b>	360
	2	500	670	<b>23184 CAKW33</b>	339



### Spherical Roller Bearings

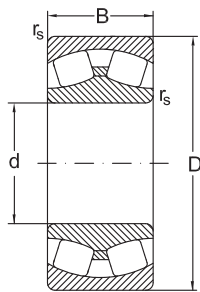

C

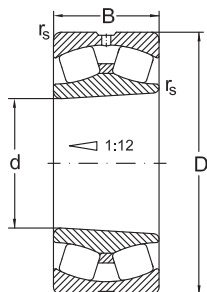

CKW33

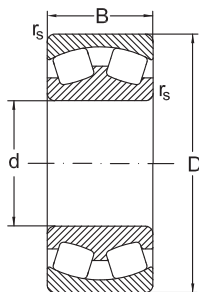

MB

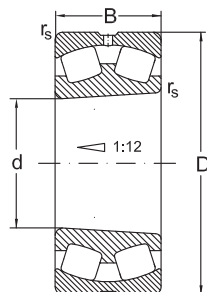

MBKW33

Dimensions				Basic radial load. Factors				
d	D	B	r <sub>s</sub> min.	dyn. C <sub>r</sub>	e	y <sub>1</sub>	y <sub>2</sub>	stat. C <sub>0r</sub>
mm				kN				kN
420	700	280	6	6200	0,33	2	3	12700
	700	280	6	6200	0,33	2	3	12700
	760	272	7,5	6575	0,35	1,9	2,9	11717
	760	272	7,5	6575	0,35	1,9	2,9	11717
440	600	118	4	2100	0,18	3,7	5,5	4690
	600	118	4	2100	0,18	3,7	5,5	4690
	650	157	6	3400	0,24	2,8	4,2	7100
	650	157	6	3400	0,24	2,8	4,2	7100
	650	212	6	4300	0,32	2,1	3,2	9650
	650	212	6	4300	0,32	2,1	3,2	9650
	720	226	6	5250	0,3	2,3	3,4	10000
	720	226	6	5250	0,3	2,3	3,4	10000
	720	280	6	6400	0,38	1,8	2,6	13200
	720	280	6	6400	0,38	1,8	2,6	13200
	790	280	7,5	7100	0,35	1,9	2,9	13400
	790	280	7,5	7100	0,35	1,9	2,9	13400
460	620	118	4	2305	0,18	3,8	5,7	5036
	620	118	4	2305	0,18	3,8	5,7	5036
	680	163	6	3650	0,24	2,8	4,2	7650
	680	163	6	3650	0,24	2,8	4,2	7650
	680	218	6	4370	0,31	2,2	3,2	9570
	680	218	6	4370	0,31	2,2	3,2	9570
	760	240	7,5	5760	0,3	2,3	3,4	11025
	760	240	7,5	5760	0,3	2,3	3,4	11025
	760	300	7,5	7500	0,39	1,7	2,6	15600

## Spherical Roller Bearings

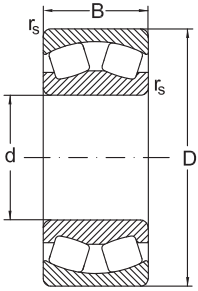

CA

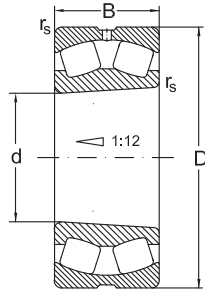

CAKW33

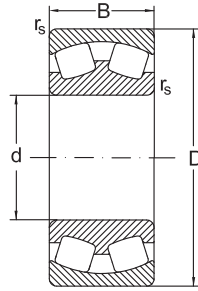

MA

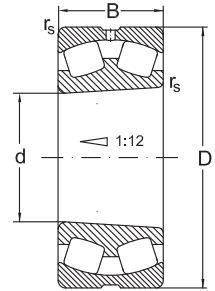

MAKW33

d	$y_0$	Speed limit		Designation	Mass
		grease	oil		
mm		min <sup>-1</sup>		Bearing	kg
420	2	400	500	<b>24184 CAW33</b>	442
	2	400	500	<b>24184 CAK30W33</b>	407
	1,8	360	480	<b>23284 CAW33</b>	558
	1,8	360	480	<b>23284 CAKW33</b>	537
440	3,6	560	750	<b>23988 CAKW33</b>	98,3
	3,6	560	750	<b>23988 CAW33</b>	101
	2,8	430	530	<b>23088 CAKW33</b>	177
	2,8	430	530	<b>23088 CAW33</b>	190
	2,1	360	450	<b>24088 CAK30W33</b>	247
	2,1	360	450	<b>24088 CAW33</b>	250
	2,2	500	670	<b>23188 CAW33</b>	381
	2,2	500	670	<b>23188 CAKW33</b>	378
	1,7	340	430	<b>24188 CAW33</b>	453
	1,7	340	430	<b>24188 CAK30W33</b>	451
	1,8	360	480	<b>23288 CAW33</b>	615
	1,8	360	480	<b>23288 CAKW33</b>	586
460	3,8	530	700	<b>23992 CAKW33</b>	103
	3,8	530	700	<b>23992 CAW33</b>	111
	2,8	400	500	<b>23092 CAKW33</b>	204
	2,8	400	500	<b>23092 CAW33</b>	208
	2,1	380	500	<b>24092 CAK30W33</b>	279
	2,1	380	500	<b>24092 CAW33</b>	282
	2,2	480	630	<b>23192 CAW33</b>	447
	2,2	480	630	<b>23192 CAKW33</b>	420
	1,7	320	400	<b>24192 CAW33</b>	582



### Spherical Roller Bearings

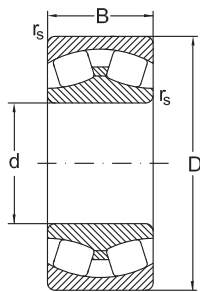

C

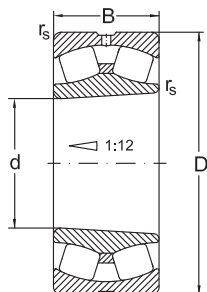

CKW33

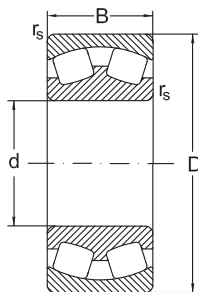

MB

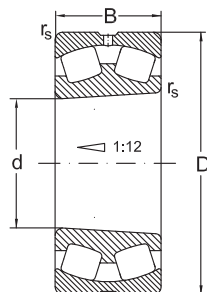

MBKW33

Dimensions				Basic radial load. Factors				
d	D	B	r <sub>s</sub> min.	dyn. C <sub>r</sub>	e	y <sub>1</sub>	y <sub>2</sub>	stat. C <sub>0r</sub>
mm				kN				kN
460	760	300	7,5	7500	0,39	1,7	2,6	15600
	830	296	7,5	7560	0,35	1,9	2,9	13970
	830	296	7,5	7560	0,35	1,9	2,9	13970
480	650	128	5	2525	0,18	3,8	5,6	5500
	650	128	5	2525	0,18	3,8	5,6	5500
	700	165	6	3800	0,23	2,9	4,3	8150
	700	165	6	3800	0,23	2,9	4,3	8150
	700	218	6	4900	0,3	2,3	3,3	11200
	700	218	6	4900	0,3	2,3	3,3	11200
	790	248	7,5	5800	0,3	2,3	3,4	11800
	790	248	7,5	5800	0,3	2,3	3,4	11800
	790	308	7,5	8000	0,39	1,8	2,6	16600
	790	308	7,5	8000	0,39	1,8	2,6	16600
	870	310	7,5	8800	0,37	1,8	2,7	17000
	870	310	7,5	8800	0,37	1,8	2,7	17000
	500	670	128	5	2500	0,17	3,9	5,8
670		128	5	2500	0,17	3,9	5,8	6090
720		167	6	3900	0,22	3	4,5	8500
720		167	6	3900	0,22	3	4,5	8500
720		218	6	4900	0,29	2,3	3,5	11200
720		218	6	4900	0,29	2,3	3,5	11200
830		264	7,5	6550	0,3	2,3	3,4	13200
830		264	7,5	6550	0,3	2,3	3,4	13200
830		325	7,5	8650	0,39	1,7	2,6	18300
830		325	7,5	8650	0,39	1,7	2,6	18300

## Spherical Roller Bearings

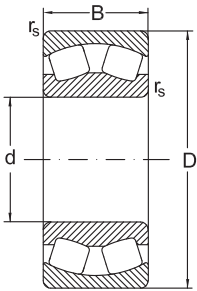

CA

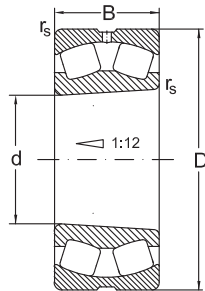

CAKW33

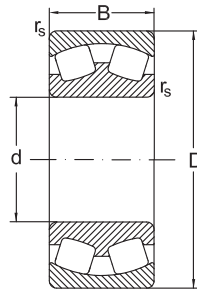

MA

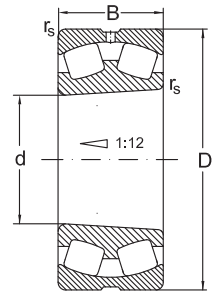

MAKW33

d	$y_0$	Speed limit		Designation	Mass
		grease	oil		
mm		min <sup>-1</sup>		Bearing	kg
460	1,7	320	400	<b>24192 CAK30W33</b>	578
	1,9	340	450	<b>23292 CAW33</b>	700
	1,9	340	450	<b>23292 CAKW33</b>	685
480	3,7	450	600	<b>23996 CAW33</b>	126
	3,7	450	600	<b>23996 CAKW33</b>	121
	2,8	380	480	<b>23096 CAKW33</b>	208
	2,8	380	480	<b>23096 CAW33</b>	222
	2,2	340	430	<b>24096 CAK30W33</b>	289
	2,2	340	430	<b>24096 CAW33</b>	291
	2,2	450	600	<b>23196 CAW33</b>	508
	2,2	450	600	<b>23196 CAKW33</b>	470
	1,7	320	400	<b>24196 CAW33</b>	705
	1,7	320	400	<b>24196 CAK30W33</b>	700
	1,8	340	430	<b>23296 CAW33</b>	830
	1,8	340	430	<b>23296 CAKW33</b>	806
500	3,8	480	630	<b>239/500 CAKW33</b>	124
	3,8	480	630	<b>239/500 CAW33</b>	132
	2,9	380	480	<b>230/500 CAKW33</b>	219
	2,9	380	480	<b>230/500 CAW33</b>	233
	2,3	320	400	<b>240/500 CAK30W33</b>	293
	2,3	320	400	<b>240/500 CAW33</b>	297
	2,2	430	560	<b>231/500 CAKW33</b>	556
	2,2	430	560	<b>231/500 CAW33</b>	588
	1,7	300	380	<b>241/500 CAW33</b>	725
	1,7	300	380	<b>241/500 CAK30W33</b>	717



### Spherical Roller Bearings

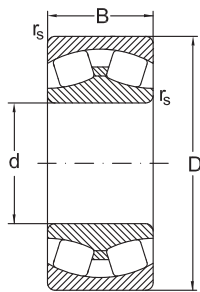

C

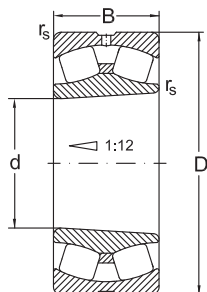

CKW33

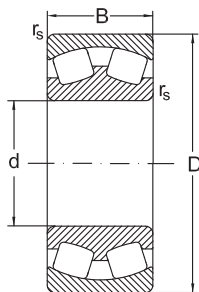

MB

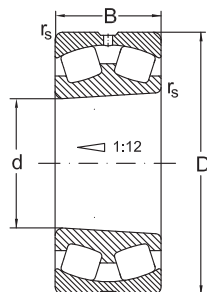

MBKW33

Dimensions				Basic radial load. Factors				
d	D	B	r <sub>s</sub> min.	dyn. C <sub>r</sub>	e	y <sub>1</sub>	y <sub>2</sub>	stat. C <sub>0r</sub>
mm				kN				kN
500	920	336	7,5	9650	0,38	1,8	2,7	18300
	920	336	7,5	9650	0,38	1,8	2,7	18300
530	710	136	5	2980	0,18	3,8	5,7	6755
	710	136	5	2980	0,18	3,8	5,7	6755
	780	185	6	4400	0,22	3	4,5	9500
	780	185	6	4400	0,22	3	4,5	9500
	780	250	6	5640	0,31	2,2	3,2	12800
	780	250	6	5640	0,31	2,2	3,2	12800
	870	335	7,5	9500	0,38	1,8	2,6	20000
	870	335	7,5	9500	0,38	1,8	2,6	20000
	870	272	7,5	7625	0,3	2,3	3,4	15000
	870	272	7,5	7625	0,3	2,3	3,4	15000
560	750	140	5	3100	0,17	4	5,9	7650
	750	140	5	3100	0,17	4	5,9	7650
	820	195	6	5100	0,23	2,9	4,4	11000
	820	195	6	5100	0,23	2,9	4,4	11000
	820	258	6	6400	0,31	2,2	3,3	14600
	820	258	6	6400	0,31	2,2	3,3	14600
	920	280	7,5	8294	0,3	2,3	3,4	16295
	920	280	7,5	8294	0,3	2,3	3,4	16295
	920	355	7,5	10600	0,38	1,8	2,6	22400
	920	355	7,5	10600	0,38	1,8	2,6	22400
600	800	150	5	3450	0,17	4	5,9	8650
	800	150	5	3450	0,17	4	5,9	8650
	870	200	6	5700	0,22	3,1	4,6	12500

## Spherical Roller Bearings

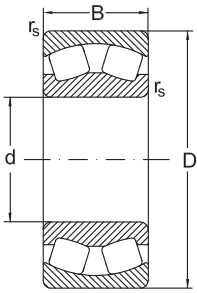

CA

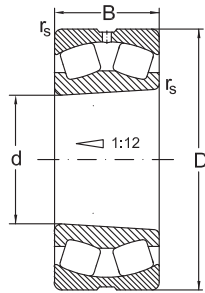

CAKW33

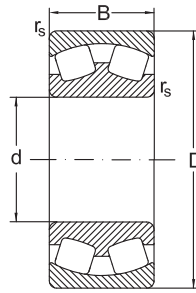

MA

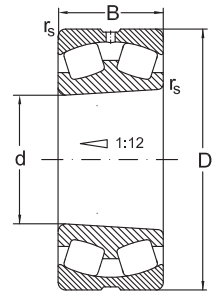

MAKW33

d	y <sub>0</sub>	Speed limit		Designation	Mass
		grease	oil		
mm		min <sup>-1</sup>		Bearing	kg
500	1,7	320	400	<b>232/500 CAW33</b>	1010
	1,7	320	400	<b>232/500 CAKW33</b>	985
530	3,8	450	600	<b>239/530 CAW33</b>	160
	3,8	450	600	<b>239/530 CAKW33</b>	146
	3	340	430	<b>230/530 CAW33</b>	321
	3	340	430	<b>230/530 CAKW33</b>	291
	2,1	340	450	<b>240/530 CAW33</b>	415
	2,1	340	450	<b>240/530 CAK30W33</b>	410
	1,7	280	360	<b>241/530 CAW33</b>	838
	1,7	280	360	<b>241/530 CAK30W33</b>	830
	2,2	400	530	<b>231/530 CAKW33</b>	643
	2,2	400	530	<b>231/530 CAW33</b>	665
560	3,9	340	430	<b>239/560 CAKW33</b>	169
	3,9	340	430	<b>239/560 CAW33</b>	181
	2,9	320	400	<b>230/560 CAKW33</b>	339
	2,9	320	400	<b>230/560 CAW33</b>	358
	2,2	280	360	<b>240/560 CAK30W33</b>	469
	2,2	280	360	<b>240/560 CAW33</b>	463
	2,2	380	500	<b>231/560 CAKW33</b>	737
	2,2	380	500	<b>231/560 CAW33</b>	760
	1,7	260	340	<b>241/560 CAW33</b>	982
	1,7	260	340	<b>241/560 CAK30W33</b>	974
600	3,9	320	400	<b>239/600 CAKW33</b>	210
	3,9	320	400	<b>239/600 CAW33</b>	224
	3	300	380	<b>230/600 CAKW33</b>	388



### Spherical Roller Bearings

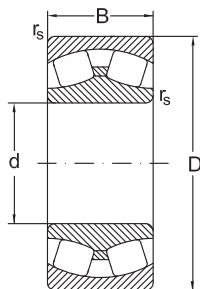

C

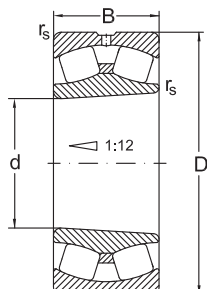

CKW33

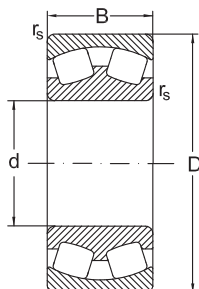

MB

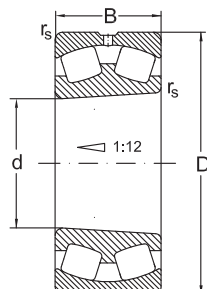

MBKW33

Dimensions				Basic radial load. Factors				
d	D	B	rs min.	dyn. Cr	e	y1	y2	stat. Cor
mm				kN				kN
<b>600</b>	870	200	6	5700	0,22	3,1	4,6	12500
	870	272	6	7100	0,31	2,2	3,3	16600
	870	272	6	7100	0,31	2,2	3,3	16600
	980	300	7,5	9000	0,31	1,8	2,7	19300
	980	300	7,5	9000	0,31	1,8	2,7	19300
	980	375	7,5	11600	0,38	1,8	2,7	26000
	980	375	7,5	11600	0,38	1,8	2,7	26000
<b>630</b>	850	165	6	4290	0,18	3,8	5,7	9910
	850	165	6	4290	0,18	3,8	5,7	9910
	920	212	7,5	6300	0,31	2,2	3,3	14000
	920	212	7,5	6300	0,31	2,2	3,3	14000
	920	290	7,5	8000	0,31	2,2	3,3	19000
	920	290	7,5	8000	0,31	2,2	3,3	19000
<b>670</b>	900	170	6	4300	0,17	4	5,9	10600
	900	170	6	4300	0,17	4	5,9	10600
	980	230	7,5	7200	0,22	3	4,5	16000
	980	230	7,5	7200	0,22	3	4,5	16000
	980	308	7,5	9000	0,31	2,2	3,3	21600
	980	308	7,5	9000	0,31	2,2	3,3	21600
<b>710</b>	950	180	6	4800	0,18	3,8	5,7	12000
	950	180	6	4800	0,18	3,8	5,7	12000
<b>750</b>	1000	185	6	5200	0,17	4	5,9	12900
	1000	185	6	5200	0,17	4	5,9	12900



## Spherical Roller Bearings

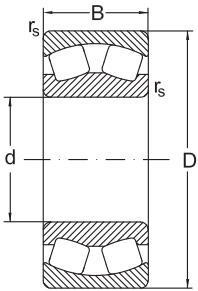

CA

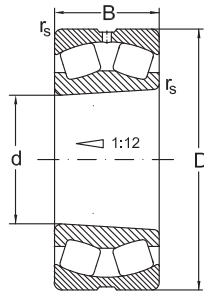

CAKW33

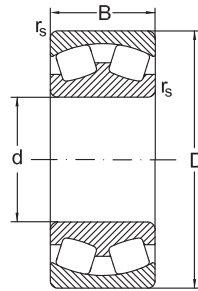

MA

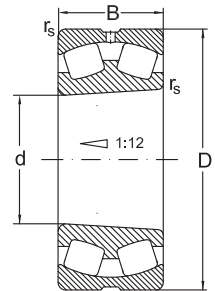

MAKW33

d	$y_0$	Speed limit		Designation	Mass
		grease	oil		
mm		min <sup>-1</sup>		Bearing	kg
600	3	300	380	<b>230/600 CAW33</b>	409
	2,2	260	340	<b>240/600 CAK30W33</b>	534
	2,2	260	340	<b>240/600 CAW33</b>	540
	2,2	280	360	<b>231/600 CAW33</b>	929
	2,2	280	360	<b>231/600 CAKW33</b>	901
	1,8	240	320	<b>241/600 CAW33</b>	1180
	1,8	240	320	<b>241/600 CAK30W33</b>	1170
630	3,7	380	500	<b>239/630 CAKW33</b>	283
	3,7	380	500	<b>239/630 CAW33</b>	292
	2,2	260	340	<b>230/630 CAKW33</b>	496
	2,2	260	340	<b>230/630 CAW33</b>	502
	2,2	260	340	<b>240/630 CAK30W33</b>	649
	2,2	260	340	<b>240/630 CAW33</b>	660
670	3,9	280	360	<b>239/670 CAKW33</b>	310
	3,9	280	360	<b>239/670 CAW33</b>	320
	2,9	260	340	<b>230/670 CAKW33</b>	590
	2,9	260	340	<b>230/670 CAW33</b>	600
	2,2	240	320	<b>240/670 CAK30W33</b>	795
	2,2	240	320	<b>240/670 CAW33</b>	802
710	3,8	260	340	<b>239/710 CAKW33</b>	336
	3,8	260	340	<b>239/710 CAW33</b>	355
750	3,9	260	340	<b>239/750 CAKW33</b>	394
	3,9	260	340	<b>239/750 CAW33</b>	426



### Spherical Roller Bearings with Adapter Sleeve

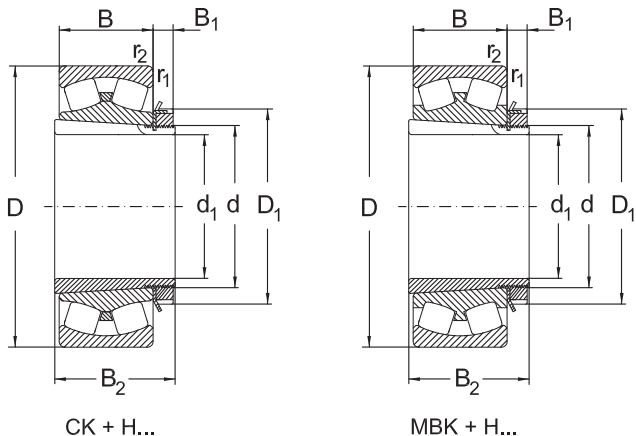

Dimensions					Designation		Basical radial load		Speed limit	
d <sub>1</sub>	d	D	B	r <sub>1</sub> , r <sub>2</sub> min.	Bearing	Adapter Sleeve	dyn. C <sub>r</sub>	stat. C <sub>0r</sub>	grease	oil
mm							kN		min <sup>-1</sup>	
20	25	52	18	1	22205 CKW33	H305	43	46	7500	10000
25	30	62	20	1	22206 CKW33	H306	59	62	6300	8500
30	35	72	23	1,1	22207 CKW33	H307	81	88	5300	7000
	35	80	21	1,5	21307 CKW33	H307	66	65	5000	6400
35	40	80	23	1,1	22208 CKW33	H308	88	98	4800	6300
	40	90	23	1,5	21308 CKW33	H308	99	120	4500	6000
	40	90	33	1,5	22308 CKW33	H2308	140	145	4300	5600
40	45	85	23	1,1	22209 CKW33	H309	93	105	4500	6000
	45	100	25	1,5	21309 CKW33	H309	120	135	4000	5300
	45	100	36	1,5	22309 CKW33	H2309	165	190	3800	5000
45	50	90	23	1,1	22210 CKW33	H310	100	120	4000	5300
	50	110	27	2	21310 CKW33	H310	120	130	3600	4800
	50	110	40	2	22310 CKW33	H2310	190	220	3400	4500
50	55	100	25	1,5	22211 CKW33	H311	120	140	3800	5000
	55	120	29	2	21311 CKW33	H311	135	155	3200	4300
	55	120	43	2	22311 CKW33	H2311	230	265	3000	4000
55	60	110	28	1,5	22212 CKW33	H312	145	175	3400	4500
	60	130	31	2,1	21312 CKW33	H312	150	180	3000	4000
	60	130	46	2,1	22312 CKW33	H2312	270	320	2800	3800

## Spherical Roller Bearings with Adapter Sleeve

Abutment and fillet dimensions  
see on page 318

Dimensions				Calculation factors				Mass	
$d_1$	$B_1$	$B_2$	$D_1$	$e$	$y_1$	$y_2$	$y_0$	Bearing	Adapter Sleeve
mm								kg	
<b>20</b>	9	29	38	0,35	1,8	2,9	1,9	0,177	0,071
<b>25</b>	9	31	45	0,33	2	3,1	2	0,281	0,095
<b>30</b>	10	35	52	0,32	2,1	3,1	2	0,428	0,14
	10	35	52	0,28	2,4	3,6	2,4	0,5	0,14
<b>35</b>	11	36	58	0,31	2,2	3,2	2,1	0,52	0,17
	11	36	58	0,26	2,6	3,9	2,6	0,7	0,17
	11	46	58	0,4	2,6	2,5	1,6	1,1	0,22
<b>40</b>	12	39	65	0,26	2,6	3,4	2,5	0,54	0,23
	12	39	65	0,26	2,6	3,9	2,6	0,93	0,23
	12	50	65	0,35	1,9	2,9	1,9	1,3	0,27
<b>45</b>	13	42	70	0,24	2,9	4,2	2,7	0,69	0,27
	13	42	70	0,24	2,8	4,1	2,7	1,2	0,27
	13	55	70	0,38	1,8	2,7	1,7	1,76	0,34
<b>50</b>	14	45	75	0,27	2,7	4,1	2,7	0,87	0,32
	14	45	75	0,24	2,8	4,1	2,7	1,65	0,32
	14	59	75	0,4	1,7	2,5	1,6	2,25	0,39
<b>55</b>	14	47	80	0,27	2,7	4	2,7	1,25	0,36
	14	47	80	0,24	2,9	4,3	2,8	1,9	0,36
	14	62	80	0,4	1,7	2,5	1,7	2,8	0,45



### Spherical Roller Bearings with Adapter Sleeve

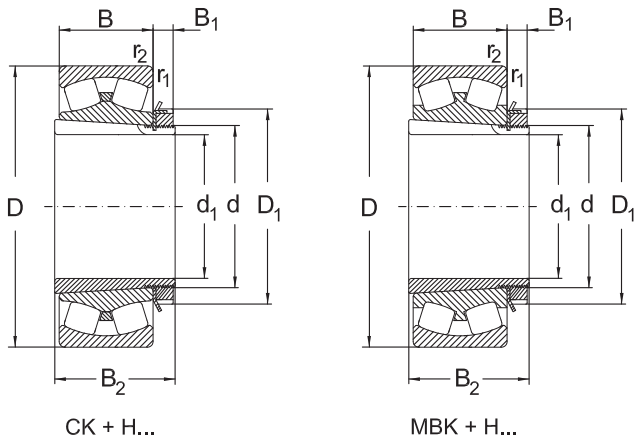

Dimensions					Designation		Basical radial load		Speed limit	
d <sub>i</sub>	d	D	B	r <sub>1</sub> , r <sub>2</sub> min.	Bearing	Adapter Sleeve	dyn, C <sub>r</sub>	stat, C <sub>0r</sub>	grease	oil
mm							kN		min <sup>-1</sup>	
60	65	120	31	1,5	22213 CKW33	H313	180	220	3000	4000
	65	140	33	2,1	21313 CKW33	H313	220	290	2800	3800
	65	140	48	2,1	22313 CKW33	H2313	305	360	2800	3600
	70	125	31	1,5	22214 CKW33	H314	180	225	2800	3800
	70	150	35	2,1	21314 CKW33	H314	250	310	2600	3400
	70	150	51	2,1	22314 CKW33	H2314	375	455	2400	3200
65	75	130	31	1,5	22215 CKW33	H315	190	250	2800	3800
	75	160	37	2,1	21315 CKW33	H315	280	360	2400	3200
	75	160	55	2,1	22315 CKW33	H2315	415	520	2200	3000
70	80	140	33	2	22216 CKW33	H316	210	275	2600	3400
	80	170	39	2,1	21316 CKW33	H316	310	400	2200	3000
	80	170	58	2,1	22316 CKW33	H2316	450	550	2000	2600
75	85	150	36	2	22217 CKW33	H317	250	325	2400	3200
	85	180	41	3	21317 CKW33	H317	350	450	2200	2800
	85	180	60	3	22317 CKW33	H2317	500	620	1800	2400
80	90	160	40	2	22218 CKW33	H318	305	410	2200	3000
	90	160	52,4	2	23218 CKW33	H2318	340	485	1500	2000
	90	190	43	3	21318 CKW33	H318	385	510	2200	2800
	90	190	64	3	22318 CKW33	H2318	570	730	1800	2400

## Spherical Roller Bearings with Adapter Sleeve

Abutment and fillet dimensions  
see on page 318

Dimensions				Calculation factors				Mass	
$d_1$	$B_1$	$B_2$	$D_1$	$e$	$y_1$	$y_2$	$y_0$	Bearing	Adapter Sleeve
mm								kg	
<b>60</b>	15	50	85	0,28	2,4	3,7	2,4	1,65	0,42
	15	50	85	0,24	2,8	4,2	2,8	2,45	0,42
	15	65	85	0,39	1,7	2,6	1,7	3,44	0,52
	15	52	92	0,26	2,6	3,9	2,6	1,8	0,67
	15	52	92	0,23	2,9	4,4	2,9	3,1	0,67
	15	68	92	0,38	1,9	2,9	1,9	4,21	0,88
<b>65</b>	16	55	98	0,24	2,9	4,4	2,9	1,86	0,78
	16	55	98	0,23	2,9	4,4	2,9	3,73	0,78
	16	73	98	0,38	1,9	2,6	1,7	5,14	1,1
<b>70</b>	18	59	105	0,25	2,6	4	2,6	2,05	0,95
	18	59	105	0,23	2,9	4,2	2,8	4,2	0,95
	18	78	105	0,35	1,9	2,9	1,8	6,12	1,2
<b>75</b>	19	63	110	0,26	2,6	3,9	2,6	2,55	1,1
	19	63	110	0,22	3	4,5	2,9	5	1,1
	19	82	110	0,33	2	3	2	7,47	1,35
<b>80</b>	19	65	120	0,27	2,5	3,8	2,5	3,31	1,3
	19	86	120	0,34	2	3	2	4,25	1,6
	19	65	120	0,22	3	4,5	2,9	5,7	1,3
	19	86	120	0,36	1,9	2,8	1,8	8,54	1,6



### Spherical Roller Bearings with Adapter Sleeve

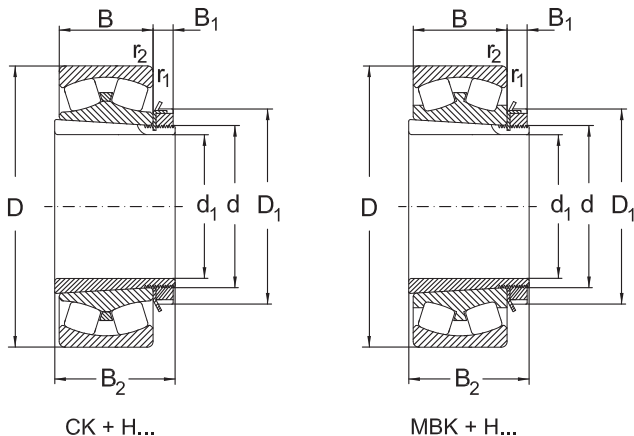

Dimensions					Designation		Basical radial load		Speed limit	
d <sub>1</sub>	d	D	B	r <sub>1</sub> , r <sub>2</sub> min.	Bearing	Adapter Sleeve	dyn.	stat.	grease	oil
mm							kN		min <sup>-1</sup>	
85	95	170	43	2,1	22219 CKW33	H319	340	450	2200	2800
	95	200	45	3	21319 CKW33	H319	385	530	2000	2600
	95	200	67	3	22319 CKW33	H2319	620	800	1700	2200
90	100	165	52	2	23120 MBKW33	H3120	355	540	2000	2600
	100	180	46	2,1	22220 CKW33	H320	375	500	2200	2800
	100	180	60,3	2,1	23220 CKW33	H2320	495	720	1700	2200
	100	215	73	3	22320 CKW33	H2320	730	960	1500	2000
100	110	170	45	2	23022 CKW33	H322	335	510	2200	3000
	110	180	56	2	23122 MBKW33	H3122	410	640	1800	2400
	110	200	53	2,1	22222 CKW33	H322	515	650	1800	2400
	110	200	69,8	2,1	23222 CKW33	H2322	620	850	1400	1800
	110	240	80	3	22322 MBKW33	H2322	800	1060	1300	1700
110	120	180	46	2	23024 CKW33	H3024	365	610	2000	2600
	120	200	62	2	23124 MBKW33	H3124	495	770	1700	2200
	120	215	58	2,1	22224 CKW33	H 3124	590	800	1700	2200
	120	215	76	2,1	23224 CKW33	H 2324	730	1120	1300	1700
	120	260	86	3	22324 CKW33	H 2324	1010	1340	1300	1700
115	130	200	52	2,1	23026 CKW33	H 3026	450	730	1800	2400
	130	210	64	2	23126 MBKW33	H3126	540	860	1500	2000

## Spherical Roller Bearings with Adapter Sleeve

Abutment and fillet dimensions  
see on page 318

Dimensions				Calculation factors				Mass	
$d_1$	$B_1$	$B_2$	$D_1$	$e$	$y_1$	$y_2$	$y_0$	Bearing	Adapter Sleeve
mm								kg	
85	20	68	125	0,24	2,8	3,8	2,8	4,15	1,4
	20	68	125	0,22	3,1	4,6	3	7,28	1,4
	20	90	125	0,35	1,9	2,9	1,8	8,5	1,8
90	21	76	130	0,31	2,2	3,2	2,1	4,5	1,8
	21	71	130	0,24	2,8	4,2	2,8	5,09	1,6
	21	97	130	0,33	2	3	2	7,13	2
	21	97	130	0,35	1,9	2,9	1,9	12,55	2
100	21	77	145	0,23	2,9	4,3	2,8	3,54	2,05
	21	81	145	0,3	2,3	3,3	2,2	5,07	2,1
	21	77	145	0,25	2,7	4	2,5	7,39	2,05
	21	105	145	0,33	2	3	2	10,8	2,75
	21	105	145	0,37	1,8	2,7	1,8	17,9	2,75
110	22	72	145	0,22	3	4,6	2,8	4,02	1,8
	22	88	155	0,31	2,2	3,3	2,2	7,84	2,5
	22	88	155	0,27	2,6	3,8	2,5	8,6	2,5
	22	112	155	0,35	1,9	2,9	1,8	13,1	3
	22	112	155	0,35	1,9	2,9	1,8	23,05	3
115	23	80	155	0,27	3	4,6	2,9	5,4	2,8
	23	92	165	0,3	2,3	3,3	2,2	8,16	3,45



### Spherical Roller Bearings with Adapter Sleeve

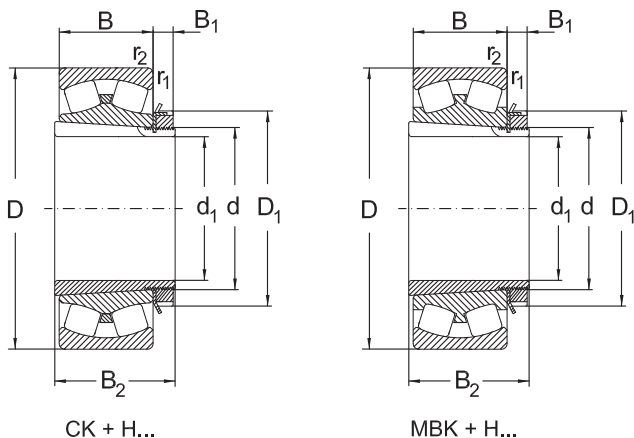

Dimensions					Designation		Basical radial load		Speed limit	
d <sub>i</sub>	d	D	B	r <sub>1</sub> , r <sub>2</sub> min.	Bearing	Adapter Sleeve	dyn, C <sub>r</sub>	stat, C <sub>0r</sub>	grease	oil
mm							kN		min <sup>-1</sup>	
115	130	230	64	3	22226CKW33	H3126	660	960	1700	2200
	130	230	80	3	23226 CKW33	H2326	830	1270	1300	1700
	130	280	93	4	22326 MBKW33	H2326	1080	1450	1100	1400
125	140	210	53	2	23028 CKW33	H3028	475	820	1700	2200
	140	225	68	2,1	23128 MBKW33	H3128	600	990	1400	1800
	140	250	68	3	22228 CKW33	H3128	730	1080	1400	1900
	140	250	88	3	23228 CKW33	H2328	960	1500	1100	1400
	140	300	102	4	22328 MBKW33	H2328	1240	1720	1000	1300
135	150	225	56	2,1	23030 CKW33	H3030	520	900	1500	2000
	150	250	80	2,1	23130 MBKW33	H3130	800	1320	1300	1700
	150	270	73	3	22230 CKW33	H3130	880	1300	1400	1800
	150	270	96	3	23230 CKW33	H2330	1090	1750	1100	1400
	150	320	108	4	22330 MBKW33	H2330	1400	1940	1000	1300
140	160	240	60	2,1	23032 CKW33	H3032	610	1060	1400	1900
	160	270	86	2,1	23132 MBKW33	H3132	930	1510	1200	1600
	160	290	80	3	22232 CKW33	H3132	1040	1550	1300	1700
	160	290	104	3	23232 CKW33	H2332	1210	1900	1000	1400
	160	340	114	4	22332 MBKW33	H2332	1520	2160	900	1200
150	170	260	67	2,1	23034 CKW33	H3034	750	1270	1400	1800



## Spherical Roller Bearings with Adapter Sleeve

Abutment and fillet dimensions  
see on page 318

Dimensions				Calculation factors				Mass	
$d_1$	$B_1$	$B_2$	$D_1$	$e$	$y_1$	$y_2$	$y_0$	Bearing	Adapter Sleeve
mm								kg	
<b>115</b>	23	92	165	0,29	2,3	3,5	2,3	10,6	3,45
	23	121	165	0,33	2	3	2	15,80	4,45
	23	121	165	0,37	1,8	2,7	1,8	28,4	4,45
<b>125</b>	24	82	165	0,22	3	4,6	2,8	6,96	3,05
	24	97	180	0,3	2,3	3,3	2,2	10,36	4,1
	24	97	180	0,26	2,6	3,5	2,5	13,97	4,1
	24	131	180	0,33	2	3	2	20,8	5,4
	24	131	180	0,38	1,7	2,6	1,7	34,37	5,4
<b>135</b>	26	87	180	0,22	3	4,6	2,8	8,32	3,75
	26	111	195	0,32	2,1	3,2	2,1	16	5,25
	26	111	195	0,26	2,6	3,9	2,5	16,99	5,25
	26	139	195	0,4	2,1	2,5	1,8	24,7	6,4
	26	139	195	0,38	1,7	2,6	1,7	40,95	6,4
<b>140</b>	28	93	190	0,22	3	4,6	2,8	9,56	5,1
	28	119	210	0,32	2,1	3,2	2,1	20,1	7,25
	28	119	210	0,26	2,6	3,9	2,5	24,6	7,25
	28	147	210	0,3	2,3	3,4	2,2	32,7	8,8
	28	147	210	0,37	1,8	2,7	1,8	48,74	8,8
<b>150</b>	29	101	200	0,23	2,9	4,4	2,8	13,78	5,8



### Spherical Roller Bearings with Adapter Sleeve

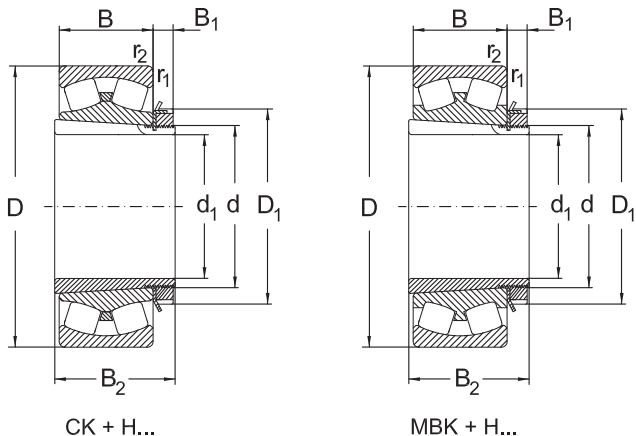

Dimensions					Designation		Basical radial load		Speed limit	
d <sub>1</sub>	d	D	B	r <sub>1</sub> , r <sub>2</sub> min.	Bearing	Adapter Sleeve	dyn. C <sub>r</sub>	stat. C <sub>0r</sub>	grease	oil
mm							kN		min <sup>-1</sup>	
150	170	280	88	2,1	<b>23134 MBKW33</b>	<b>H3134</b>	990	1650	1100	1500
	170	310	86	4	<b>22234 CKW33</b>	<b>H3134</b>	1170	1750	1200	1600
	170	310	110	4	<b>23234 CKW33</b>	<b>H2334</b>	1500	2350	950	1250
	170	360	120	4	<b>22334 MBKW33</b>	<b>H2334</b>	1690	2380	850	1100
160	180	280	74	2,1	<b>23036 CKW33</b>	<b>H3036</b>	870	1500	1300	1700
	180	300	96	3	<b>23136 CKW33</b>	<b>H3136</b>	1260	2110	1200	1600
	180	320	86	4	<b>22236 CKW33</b>	<b>H3136</b>	1210	1870	1100	1500
	180	320	112	4	<b>23236 MBKW33</b>	<b>H2336</b>	1420	2330	750	1000
	180	380	126	4	<b>22336 MBKW33</b>	<b>H2336</b>	1860	2500	850	1100
170	190	290	75	2,1	<b>23038 CKW33</b>	<b>H3038</b>	915	1530	1300	1700
	190	320	104	3	<b>23138 MBKW33</b>	<b>H3138</b>	1320	2290	1100	1400
	190	340	92	4	<b>22238 CKW33</b>	<b>H3138</b>	1330	2040	1100	1400
	190	340	120	4	<b>23238 CKW33</b>	<b>H2338</b>	1750	2880	850	1100
	190	400	132	5	<b>22338 MBKW33</b>	<b>H2338</b>	1900	2700	750	1000
180	200	310	82	2,1	<b>23040 CKW33</b>	<b>H3040</b>	1060	1760	1300	1700
	200	340	112	3	<b>23140 MBKW33</b>	<b>H3140</b>	1370	2460	1100	1400
	200	360	98	4	<b>22240 CKW33</b>	<b>H3140</b>	1250	2020	1100	1400
	200	360	128	4	<b>23240 CKW33</b>	<b>H2340</b>	1620	2590	750	1000
	200	420	138	5	<b>22340 MBKW33</b>	<b>H2340</b>	1910	2750	670	900

## Spherical Roller Bearings with Adapter Sleeve

Abutment and fillet dimensions  
see on page 318

Dimensions				Calculation factors				Mass	
d <sub>1</sub>	B <sub>1</sub>	B <sub>2</sub>	D <sub>1</sub>	e	y <sub>1</sub>	y <sub>2</sub>	y <sub>0</sub>	Bearing	Adapter Sleeve
mm								kg	
<b>150</b>	29	122	220	0,31	2,2	3,2	2,1	21,2	8,1
	29	122	220	0,27	2,5	3,7	2,5	31,66	8,1
	29	154	220	0,35	1,9	2,9	1,8	34,55	9,9
	29	154	220	0,37	1,8	2,7	1,8	56,7	9,9
<b>160</b>	30	109	210	0,24	2,8	4,2	2,8	18,13	6,7
	30	131	230	0,3	2,3	3,4	2,2	29,38	9,15
	30	131	230	0,26	2,6	3,9	2,5	32,11	9,15
	30	161	230	0,36	1,9	2,8	1,8	38,36	11
	30	161	230	0,37	1,8	2,7	1,8	66,451	11
<b>170</b>	31	112	220	0,23	3	4,4	2,9	15,8	7,25
	31	141	240	0,33	2	3	2	36,09	10,5
	31	141	240	0,26	2,6	3,9	2,5	36,8	10,5
	31	169	240	0,35	1,9	2,9	1,8	52,4	12
	31	169	240	0,37	1,8	2,7	1,8	80,5	12
<b>180</b>	32	120	240	0,23	2,9	4,3	2,8	21,8	8,9
	32	150	250	0,35	1,9	2,9	1,9	43,5	12
	32	150	250	0,29	2,3	3,9	2,3	44,4	12
	32	176	250	0,35	1,9	2,9	1,8	58,4	13,5
	32	176	250	0,36	1,8	2,8	1,8	91,8	13,5



### Spherical Roller Bearings with Adapter Sleeve

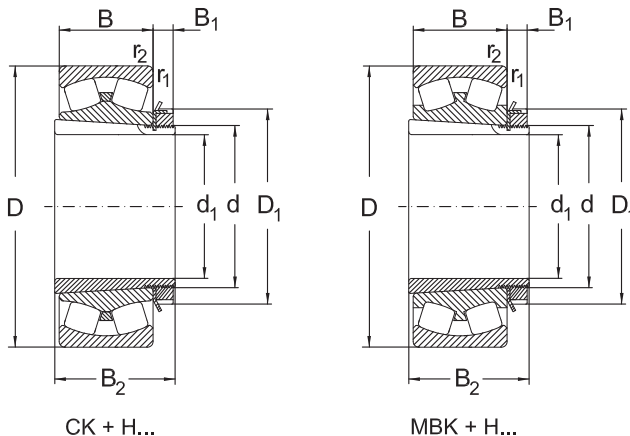

Dimensions					Designation		Basical radial load		Speed limit	
d <sub>1</sub>	d	D	B	r <sub>1</sub> , r <sub>2</sub> min.	Bearing	Adapter Sleeve	dyn, C <sub>r</sub>	stat, C <sub>0r</sub>	grease	oil
mm							kN		min <sup>-1</sup>	
200	220	340	90	3	23044 MBKW33	OH3044 H	1025	1730	900	1200
	220	370	120	4	23144 MBKW33	OH3144 H	1515	2509	1000	1300
	220	400	108	4	22244 CKW33	OH3144H	1545	2300	900	1200
	220	400	144	4	23244 CKW33	OH2344 H	2065	3380	670	900
	220	460	145	5	22344 CKW33	OH2344 H	2380	3407	700	950
220	240	360	92	3	23048 MBKW33	OH3048 H	1090	1960	800	1000
	240	400	128	4	23148 MBKW33	OH3148 H	1705	2863	900	1200
	240	440	120	4	22248 CKW33	OH3148 H	1845	2763	850	1100
	240	440	160	4	23248 CKW33	OH2348 H	2530	4600	630	850
	240	500	155	5	22348 MBKW33	OH2348 H	2650	4000	560	750
240	260	400	104	4	23052 MBKW33	OH3052 H	1500	2800	750	950
	260	440	144	4	23152 MBKW33	OH3152	2153	3673	850	1100
	260	480	130	5	22252 MBKW33	OH3152 H	2190	3300	750	1000
	260	540	165	6	22352 CKW33	OH2352 H	3125	4560	600	800
260	280	420	106	4	23056 MBKW33	OH3056 H	1560	3000	700	900
	280	460	146	5	23156 MBKW33	OH3156 H	2295	4050	750	1000
	280	500	130	5	22256 MBKW33	OH3156 H	2330	3600	700	950
	280	500	176	5	23256 MBKW33	OH2356 H	2806	4645	480	630
	280	580	175	6	22356 CKW33	OH2356 H	3530	5208	560	750

## Spherical Roller Bearings with Adapter Sleeve

Abutment and fillet dimensions  
see on page 318

Dimensions				Calculation factors				Mass	
$d_1$	$B_1$	$B_2$	$D_1$	$e$	$y_1$	$y_2$	$y_0$	Bearing	Adapter Sleeve
mm								kg	
<b>200</b>	30	126	260	0,26	2,6	3,8	2,5	31	9,9
	35	161	280	0,3	2,3	3,4	2,2	52	15
	35	161	280	0,29	2,3	3,4	2,3	61,4	15
	35	186	280	0,35	1,9	2,9	1,8	79,5	17
	35	186	280	0,36	1,8	2,8	1,8	120	17
<b>220</b>	34	133	290	0,25	2,7	4,1	2,7	33,9	12
	37	172	300	0,3	2,3	3,4	2,2	66	16
	37	172	300	0,29	2,3	3,4	2,3	83,2	16
	37	199	300	0,35	1,9	2,9	1,8	109	19
	37	199	300	0,31	2,2	3,3	2,2	151	19
<b>240</b>	34	145	310	0,26	2,6	3,9	2,6	49	13,5
	38	190	330	0,31	2,2	3,3	2,2	92,5	21
	38	190	330	0,29	2,3	3,4	2,3	107	21
	38	211	330	0,36	1,8	2,8	1,8	187	21
<b>260</b>	38	152	330	0,25	2,7	4,1	2,7	52,5	16
	39	195	350	0,3	2,3	3,4	2,2	98,5	23
	39	195	350	0,29	2,3	3,4	2,3	113	23
	39	224	350	0,35	1,9	2,9	1,8	153	27
	39	224	350	0,36	1,8	2,8	1,8	235	27



### Spherical Roller Bearings with Adapter Sleeve

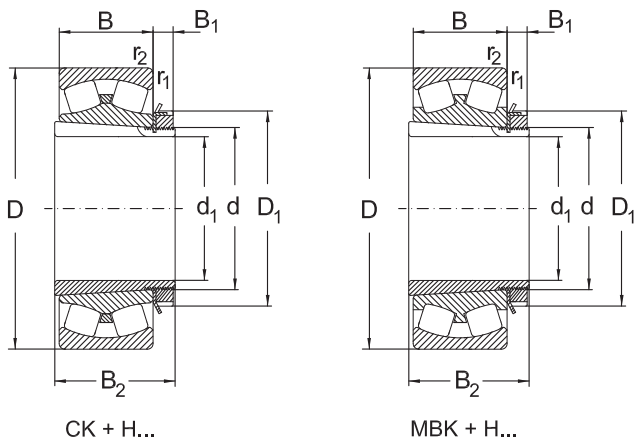

Dimensions					Designation		Basical radial load		Speed limit	
d <sub>i</sub>	d	D	B	r <sub>1</sub> , r <sub>2</sub> min.	Bearing	Adapter Sleeve	dyn, C <sub>r</sub>	stat, C <sub>0r</sub>	grease	oil
mm							kN		min <sup>-1</sup>	
280	300	460	118	4	23060 MBKW33	OH3060 H	1960	3650	630	800
	300	500	160	5	23160 MBKW33	OH3160 H	2385	4485	700	950
	300	540	140	5	22260 CAKW33	OH3160 H	2655	4230	670	900
300	320	480	121	4	23064 MBKW33	OH3064 H	2040	4000	600	750
	320	540	176	5	23164 MBKW33	OH3164 H	3115	6000	530	670
	320	580	150	5	22264 CAKW33	OH3164 H	2997	4740	630	580
	320	580	208	5	23264 MBKW33	OH3264 H	4130	7026	430	560
320	340	520	133	5	23068 CAKW33	OH3068 H	2360	4500	560	700
	340	580	190	5	23168 CAKW33	OH3168 H	3740	6640	630	850
340	360	540	134	5	23072 CAKW33	OH3072 H	2450	4800	530	670
	360	600	192	5	23172 CAKW33	OH3172 H	3810	7010	600	800
	360	650	232	6	23272 CAKW33	OH3272 H	4880	8490	430	560
360	380	560	135	5	23076 CAKW33	OH3076 H	2550	5300	500	630
	380	640	194	5	23176 CAKW33	OH3176 H	3890	7540	560	750
	380	680	240	6	23276 CAKW33	OH3276 H	5050	9660	400	530
380	400	600	148	5	23080 CAKW33	OH3080 H	3050	6200	450	560
	400	650	200	6	23180 CAKW33	OH3180 H	4500	7900	530	700
	400	720	256	6	23280 CAKW33	OH3280 H	5950	10807	380	500
400	420	620	150	5	23084 CAKW33	OH3084 H	3150	6550	450	560

## Spherical Roller Bearings with Adapter Sleeve

Abutment and fillet dimensions  
see on page 318

Dimensions				Calculation factors				Mass	
$d_1$	$B_1$	$B_2$	$D_1$	$e$	$y_1$	$y_2$	$y_0$	Bearing	Adapter Sleeve
mm								kg	
<b>280</b>	42	168	360	0,25	2,7	4	2,6	73,6	20,5
	40	208	380	0,3	2,3	3,4	2,2	129	29
	40	208	380	0,29	2,3	3,4	2,3	142	29
<b>300</b>	42	171	380	0,25	2,7	4,1	2,7	79,5	22
	42	226	400	0,34	2	3	1,9	165	32
	42	226	400	0,29	2,5	3,7	2,5	180	32
	42	258	400	0,35	1,9	2,9	1,8	247	35
<b>320</b>	45	187	400	0,25	2,7	4	2,6	101	27
	55	254	440	0,31	2,2	3,2	2,2	212	50
<b>340</b>	45	188	420	0,25	2,7	4,1	2,7	107	29
	58	259	460	0,33	2,3	3,4	2,2	217	56
	58	299	460	0,35	1,9	2,9	1,8	328	60,5
<b>360</b>	48	193	450	0,25	2,8	4,2	2,8	113	35,5
	60	264	490	0,3	2,3	3,4	2,2	240	61,5
	60	310	490	0,35	1,9	2,9	1,8	367	69,5
<b>380</b>	52	210	470	0,24	2,8	4,1	2,7	143	40
	62	272	520	0,28	2,4	3,6	2,5	261	73
	62	328	520	0,35	1,9	2,9	1,8	442	87
<b>400</b>	52	212	490	0,24	2,8	4,2	2,8	155	47



### Spherical Roller Bearings with Adapter Sleeve

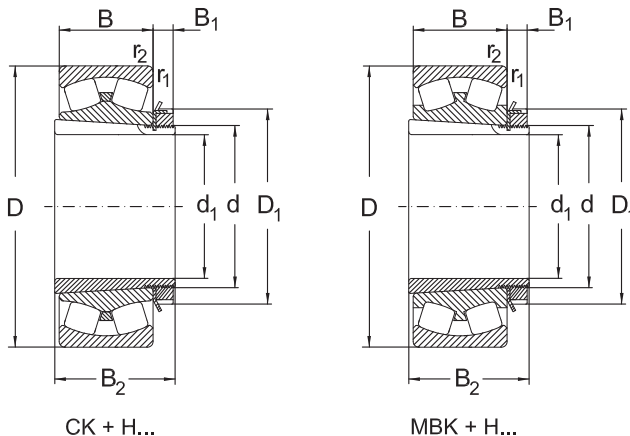

Dimensions					Designation		Basical radial load		Speed limit	
d <sub>i</sub>	d	D	B	r <sub>1</sub> , r <sub>2</sub> min.	Bearing	Adapter Sleeve	dyn, C <sub>r</sub>	stat. C <sub>0r</sub>	grease	oil
mm							kN		min <sup>-1</sup>	
400	420	700	224	6	23184 CAKW33	OH3184 H	4600	9000	500	670
	420	760	272	7,5	23284 CAKW33	OH3284 H	6575	11717	360	480
410	440	650	157	6	23088 CAKW33	OH3088 H	3400	7100	430	530
	440	720	226	6	23188 CAKW33	OH3188 H	5250	10000	500	670
	440	790	280	7,5	23288 CAKW33	OH3288 H	7100	13400	360	480
430	460	680	163	6	23092 CAKW33	OH3092 H	3650	7650	400	500
	460	760	240	7,5	23192 CAKW33	OH3192 H	5760	11025	480	630
	460	830	296	7,5	23292 CAKW33	OH3292 H	7560	13970	340	450
450	480	700	165	6	23096 CAKW33	OH3096 H	3800	8150	380	480
	480	790	248	7,5	23196 CAKW33	OH3196 H	5800	11800	450	600
	480	870	310	7,5	23296 CAKW33	OH3296 H	8800	17000	340	430
470	500	670	128	5	239/500 CAKW33	H39/500	2500	6090	480	630
	500	720	167	6	230/500 CAKW33	OH30/500 H	3900	8500	380	480
	500	830	264	7,5	231/500 CAKW33	OH31/500 H	6550	13200	430	560
	500	920	336	7,5	232/500 CAKW33	OH32/500 H	9650	18300	320	400
500	530	710	136	5	239/530 CAKW33	H39/530	2980	6755	450	600
	530	780	185	6	230/530 CAKW33	OH30/530 H	4400	9500	340	430
530	560	750	140	5	239/560 CAKW33	OH39/560 H	3100	7650	340	430
	560	820	195	6	230/560 CAKW33	OH30/560 H	5100	11000	320	400



## Spherical Roller Bearings with Adapter Sleeve

Abutment and fillet dimensions  
see on page 318

Dimensions				Calculation factors				Mass	
$d_1$	$B_1$	$B_2$	$D_1$	$e$	$y_1$	$y_2$	$y_0$	Bearing	Adapter Sleeve
mm								kg	
<b>400</b>	70	304	540	0,33	2	3	2	339	80
	70	352	540	0,35	1,9	2,9	1,8	537	96
<b>410</b>	60	228	520	0,24	2,8	4,2	2,8	177	65
	70	307	560	0,3	2,3	3,4	2,2	378	95
	70	361	560	0,35	1,9	2,9	1,8	586	117
<b>430</b>	60	234	540	0,24	2,8	4,2	2,8	204	71
	75	326	580	0,3	2,3	3,4	2,2	420	119
	75	382	580	0,35	1,9	2,9	1,9	685	134
<b>450</b>	60	237	560	0,23	2,9	4,3	2,8	208	75
	75	335	620	0,3	2,3	3,4	2,2	470	135
	75	397	620	0,37	1,8	2,7	1,8	806	153
<b>470</b>	68	208	580	0,17	3,9	5,8	3,8	124	74,3
	68	247	580	0,22	3	4,5	2,9	219	82
	80	356	630	0,3	2,3	3,4	2,2	556	145
	80	428	630	0,38	1,8	2,7	1,7	985	170
<b>500</b>	68	216	630	0,18	3,8	5,7	3,8	146	87,9
	68	265	630	0,22	3	4,5	3	291	105
<b>530</b>	75	227	650	0,17	4	5,9	3,9	169	95
	75	282	650	0,23	2,9	4,4	2,9	339	112



### Spherical Roller Bearings with Adapter Sleeve

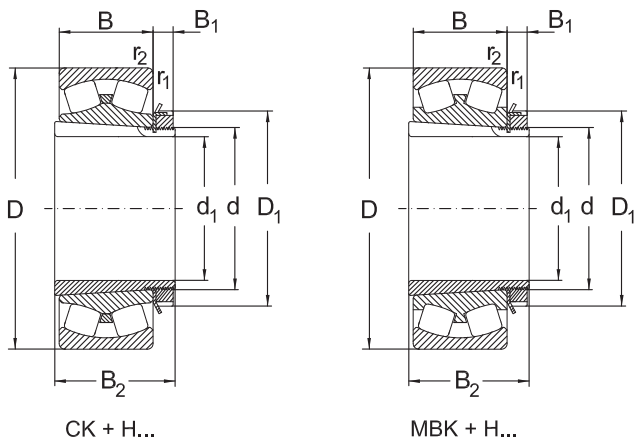

Dimensions					Designation		Basical radial load		Speed limit	
d <sub>1</sub>	d	D	B	r <sub>1</sub> , r <sub>2</sub> min.	Bearing	Adapter Sleeve	dyn, C <sub>r</sub>	stat, C <sub>0r</sub>	grease	oil
mm							kN		min <sup>-1</sup>	
<b>560</b>	600	800	150	5	<b>239/600 CAKW33</b>	<b>OH39/600 H</b>	3450	8650	320	400
	600	870	200	6	<b>230/600 CAKW33</b>	<b>OH30/600 H</b>	5700	12500	300	380
<b>600</b>	630	850	165	6	<b>239/630 CAKW33</b>	<b>OH39/630 H</b>	4290	9910	380	500
	630	920	212	7,5	<b>230/630 CAKW33</b>	<b>OH30/630 H</b>	6300	14000	260	340
<b>630</b>	670	900	170	6	<b>239/670 CAKW33</b>	<b>OH39/670 H</b>	4300	10600	280	360
	670	980	230	7,5	<b>230/670 CAKW33</b>	<b>OH30/670 H</b>	7200	16000	260	340
<b>670</b>	710	950	180	6	<b>239/710 CAKW33</b>	<b>OH39/710 H</b>	4800	12000	260	340
<b>710</b>	750	1000	185	6	<b>239/750 CAKW33</b>	<b>OH39/750 H</b>	5200	12900	260	340

## Spherical Roller Bearings with Adapter Sleeve

Abutment and fillet dimensions  
see on page 318

Dimensions				Calculation factors				Mass	
$d_1$	$B_1$	$B_2$	$D_1$	$e$	$y_1$	$y_2$	$y_0$	Bearing	Adapter Sleeve
mm								kg	
<b>560</b>	75	239	700	0,17	4	5,9	3,9	210	127
	75	289	700	0,22	3,1	4,6	3	388	147
<b>600</b>	75	254	730	0,18	3,8	5,7	3,7	283	124
	75	301	730	0,31	2,2	3,3	2,2	496	138
<b>630</b>	80	264	780	0,17	4	5,9	3,9	310	162
	80	324	780	0,22	3	4,5	2,9	590	190
<b>670</b>	90	286	830	0,18	3,8	5,7	3,8	336	183
<b>710</b>	90	291	870	0,17	4	5,9	3,9	394	211



### Spherical Roller Bearings with Withdrawal Sleeve

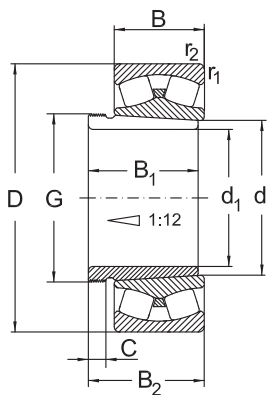

CK + AH...

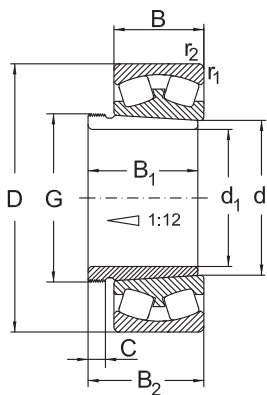

MBK + AH...

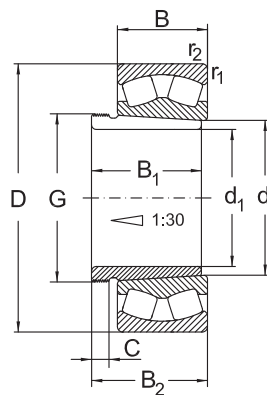

CAK30 + AH...

Dimensions					Designation		Basical radial load		Speed limit	
d <sub>1</sub>	d	D	B	r <sub>1</sub> , r <sub>2</sub> min.	Bearing	Withdrawal Sleeve	dyn. C <sub>r</sub>	stat. C <sub>0r</sub>	grease	oil
mm							kN		min <sup>-1</sup>	
35	40	80	23	1,1	22208 CKW33	AH308	88	98	4800	6300
	40	90	23	1,5	21308 CKW33	AH308	99	120	4500	6000
	40	90	33	1,5	22308 CKW33	AH2308	140	145	4300	5600
40	45	85	23	1,1	22209 CKW33	AH309	93	105	4500	6000
	45	100	25	1,5	21309 CKW33	AH309	120	135	4000	5300
	45	100	36	1,5	22309 CKW33	AH2309	165	190	3800	5000
45	50	90	23	1,1	22210 CKW33	AHX310	100	120	4000	5300
	50	110	27	2	21310 CKW33	AHX310	120	130	3600	4800
	50	110	40	2	22310 CKW33	AHX2310	190	220	3400	4500
50	55	100	25	1,5	22211 CKW33	AHX311	120	140	3800	5000
	55	120	29	2	21311 CKW33	AHX311	135	155	3200	4300
	55	120	43	2	22311 CKW33	AHX2311	230	265	3000	4000
55	60	110	28	1,5	22212 CKW33	AHX312	145	175	3400	4500
	60	130	31	2,1	21312 CKW33	AHX312	150	180	3000	4000
	60	130	46	2,1	22312 CKW33	AHX2312	270	320	2800	3800
60	65	120	31	1,5	22213 CKW33	AH313	180	220	3000	4000
	65	140	33	2,1	21313 CKW33	AH313	220	290	2800	3800
	65	140	48	2,1	22313 CKW33	AH2313	305	360	2800	3600
65	70	125	31	1,5	22214 CKW33	AH314	180	225	2800	3800

## Spherical Roller Bearings with Withdrawal Sleeve

Abutment and fillet dimensions  
see on page 318

Dimensions									Mass	
$d_1$	$B_1$	$B_2$	C	G	e	$y_1$	$y_2$	$y_0$	Bearing	Withdrawal Sleeve
mm									kg	
35	29	32	6	M 45x1,5	0,31	2,2	3,2	2,1	0,54	0,09
	29	32	6	M 45x1,5	0,26	2,6	3,9	2,6	0,7	0,09
	40	43	7	M 45x1,5	0,4	1,6	2,5	1,6	0,95	0,13
40	31	34	6	M 50x1,5	0,26	2,6	3,4	2,5	0,7	0,12
	31	34	6	M 50x1,5	0,26	2,6	3,9	2,6	0,93	0,12
	44	47	7	M 50x1,5	0,35	1,9	2,9	1,9	1,3	0,13
45	35	38	7	M 55x2	0,24	2,9	4,2	2,7	0,7	0,13
	35	38	7	M 55x2	0,24	2,8	4,1	2,7	1,2	0,13
	50	53	9	M 55x2	0,38	1,8	2,7	1,7	1,77	0,19
50	37	40	7	M 60x2	0,27	2,7	4,1	2,7	0,9	0,16
	37	40	7	M 60x2	0,24	2,8	4,1	2,7	1,6	0,16
	54	57	10	M 60x2	0,4	1,7	2,5	1,6	2,27	0,26
55	40	43	8	M 65x2	0,27	2,7	4	2,7	1,29	0,19
	40	43	8	M 65x2	0,24	2,9	4,3	2,8	1,9	0,19
	58	61	11	M 65x2	0,4	1,7	2,5	1,7	2,84	0,3
60	42	45	8	M 75x2	0,28	2,4	3,6	2,4	1,71	0,25
	42	45	8	M 75x2	0,24	2,8	4,2	2,8	2,43	0,25
	61	64	12	M 75x2	0,39	1,7	2,6	1,7	3,49	0,25
65	43	47	8	M 80x2	0,26	2,6	3,9	2,6	1,82	0,28



### Spherical Roller Bearings with Withdrawal Sleeve

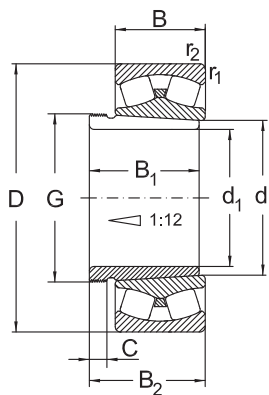

CK + AH...

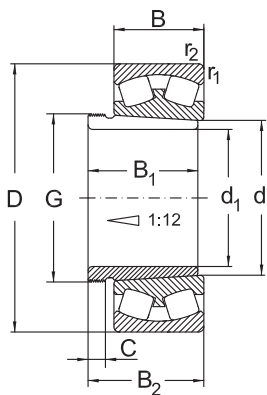

MBK + AH...

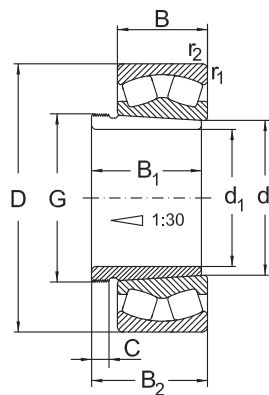

CAK30 + AH...

Dimensions					Designation		Basical radial load		Speed limit	
d <sub>1</sub>	d	D	B	r <sub>1</sub> , r <sub>2</sub> min.	Bearing	Withdrawal Sleeve	dyn. C <sub>r</sub>	stat. C <sub>0r</sub>	grease	oil
mm							kN		min <sup>-1</sup>	
65	70	150	35	2,1	21314 CKW33	AH314	250	310	2600	3400
	70	150	51	2,1	22314 CKW33	AHX2314	375	455	2400	3200
70	75	130	31	1,5	22215 CKW33	AH315	190	250	2800	3800
	75	160	37	2,1	21315 CKW33	AH315	280	360	2400	3200
	75	160	55	2,1	22315 CKW33	AHX2315	415	520	2200	3000
75	80	140	33	2	22216 CKW33	AH316	210	275	2600	3400
	80	170	39	2,1	21316 CKW33	AH316	310	400	2200	3000
	80	170	58	2,1	22316 CKW33	AHX2316	450	550	2000	2600
80	85	150	36	2	22217 CKW33	AHX317	250	325	2400	3200
	85	180	41	3	21317 CKW33	AHX317	350	450	2200	2800
	85	180	60	3	22317 CKW33	AHX2317	500	620	1800	2400
85	90	160	40	2	22218 CKW33	AHX318	305	410	2200	3000
	90	160	52,4	2	23218 CKW33	AHX2318	340	485	2200	3000
	90	190	43	3	21318 CKW33	AHX318	385	510	2200	2800
	90	190	64	3	22318 CKW33	AH2318	570	730	1800	2400
90	95	170	43	2,1	22219 CKW33	AHX319	340	450	2200	2800
	95	200	45	3	21319 CKW33	AHX319	385	530	2000	2600
	95	200	67	3	22319 CKW33	AHX2319	620	800	1700	2200
95	100	165	52	2	23120 MBKW33	AHX3120	355	540	2000	2600

## Spherical Roller Bearings with Withdrawal Sleeve

Abutment and fillet dimensions  
see on page 318

Dimensions									Mass	
d <sub>1</sub>	B <sub>1</sub>	B <sub>2</sub>	C	G	e	y <sub>1</sub>	y <sub>2</sub>	y <sub>0</sub>	Bearing	Withdrawal Sleeve
mm									kg	
65	43	47	8	M 80x2	0,23	2,9	4,4	2,9	3,1	0,28
	64	68	12	M 80x2	0,38	1,9	2,9	1,9	4,32	0,46
70	45	49	8	M 85x2	0,23	2,9	4,4	2,9	1,88	0,31
	45	49	8	M 85x2	0,23	2,9	4,4	2,9	3,73	0,31
	68	72	12	M 85x2	0,38	1,8	2,6	1,7	5,16	0,53
75	48	52	8	M 90x2	0,25	2,6	4	2,6	2,07	0,37
	48	52	8	M 90x2	0,23	2,9	4,2	2,8	4,2	0,37
	71	75	12	M 90x2	0,35	1,9	2,9	1,8	6,14	0,6
80	52	56	9	M 95x2	0,26	2,6	3,9	2,6	2,52	0,43
	52	56	9	M 95x2	0,22	3	4,5	2,9	5	0,43
	74	78	13	M 95x2	0,33	2	3	2	7,52	0,65
85	53	57	9	M100x2	0,27	2,5	3,8	2,5	3,33	0,46
	63	67	10	M100x2	0,34	2	3	2	4,25	0,57
	53	57	9	M100x2	0,22	3	4,5	2,9	5,7	0,46
	79	83	14	M100x2	0,36	1,9	2,8	1,8	8,5	0,76
90	57	61	10	M105x2	0,24	2,8	4,2	2,8	4,17	0,54
	57	61	10	M105x2	0,22	3,1	4,6	3	7,28	0,54
	85	89	16	M105x2	0,35	1,9	2,9	1,8	8,61	0,9
95	64	68	11	M110x2	0,31	2,2	3,2	2,1	4,53	0,66



### Spherical Roller Bearings with Withdrawal Sleeve

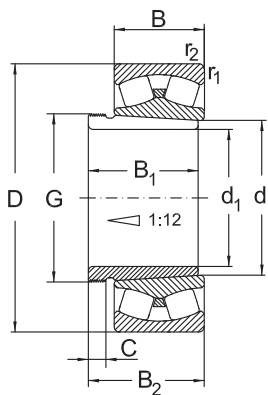

CK + AH...

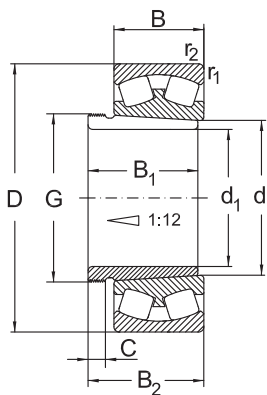

MBK + AH...

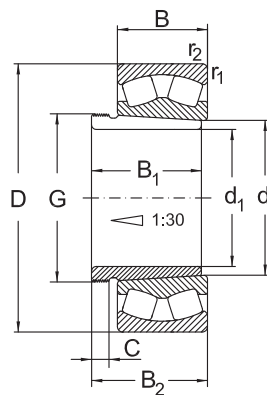

CAK30 + AH...

Dimensions					Designation		Basical radial load		Speed limit	
d <sub>1</sub>	d	D	B	r <sub>1</sub> , r <sub>2</sub> min.	Bearing	Withdrawal Sleeve	dyn. C <sub>r</sub>	stat. C <sub>0r</sub>	grease	oil
mm							kN		min <sup>-1</sup>	
95	100	180	46	2,1	22220 CKW33	AHX320	375	500	2200	2800
	100	180	60,3	2,1	23220 CKW33	AHX2320	495	720	1700	2200
	100	215	73	3	22320 CKW33	AHX2320	730	960	1500	2000
105	110	180	56	2	23122 MBKW33	AHX3122	410	640	1800	2400
	110	180	69	2	24122 CK30W33	AH24122	520	880	1200	1600
	110	200	53	2,1	22222 CKW33	AHX3122	515	650	1800	2400
	110	200	69,8	2,1	23222 CKW33	AHX3222	620	850	1400	1800
	110	240	80	3	22322 MBKW33	AHX2322	800	1060	1300	1700
115	120	180	46	2	23024 CKW33	AHX3024	365	610	2000	2600
	120	180	60	2	24024 CK30W33	AH24024	455	800	1500	2000
	120	200	62	2	23124 MBKW33	AHX3124	495	770	1700	2200
	120	200	80	2	24124 CK30W33	AH24124	630	1050	1000	1300
	120	215	58	2,1	22224 CKW33	AHX3124	590	800	1700	2200
	120	215	76	2,1	23224 CKW33	AHX3224	730	1120	1300	1700
	120	260	86	3	22324 MBKW33	AHX2324	930	1230	1100	1500
125	130	200	52	2	23026 CKW33	AHX3026	450	730	1800	2400
	130	200	69	2	24026 CK30W33	AH24026	530	900	1200	1600
	130	210	64	2	23126 MBKW33	AHX3126	540	860	1500	2000
	130	210	80	2	24126 CK30W33	AH24126	650	1100	900	1200



## Spherical Roller Bearings with Withdrawal Sleeve

Abutment and fillet dimensions  
see on page 318

Dimensions									Mass	
$d_1$	$B_1$	$B_2$	C	G	e	$y_1$	$y_2$	$y_0$	Bearing	Withdrawal Sleeve
mm									kg	
95	59	63	10	M110x2	0,24	2,8	4,2	2,8	5,13	0,58
	73	77	11	M110x2	0,33	2	3	2	7,19	0,76
	90	94	16	M110x2	0,35	1,9	2,9	1,9	12,67	1
105	68	72	11	M120x2	0,3	2,3	3,3	2,2	5,18	0,76
	82	91	13	M115x2	0,35	1,9	2,9	1,9	7,65	0,73
	68	72	11	M120x2	0,25	2,7	4	2,5	7,45	0,76
	82	86	11	M120x2	0,33	2	3	2	10,8	0,88
	98	102	16	M125x2	0,37	1,8	2,7	1,8	17,2	1,35
115	60	64	13	M130x2	0,22	3	4,6	2,8	4,11	0,75
	73	82	13	M125x2	0,29	2,3	3,4	2,3	5,85	0,65
	75	79	12	M130x2	0,31	2,2	3,3	2,2	7,9	0,94
	93	102	13	M130x2	0,37	1,8	2,7	1,8	11	1
	75	79	12	M125x2	0,27	2,6	3,8	2,5	8,7	0,94
	90	94	13	M135x2	0,35	1,9	2,9	1,8	13,1	1,11
	105	109	17	M135x2	0,36	1,8	2,7	1,8	22,93	1,65
125	67	71	14	M140x2	0,27	3	4,6	2,9	5,7	0,93
	83	93	14	M135x2	0,31	2,2	3,3	2,2	8,56	0,84
	78	82	12	M140X2	0,3	2,3	3,3	2,2	8,36	1,1
	94	104	14	M140X2	0,34	2	2,9	1,9	11,7	1,11



### Spherical Roller Bearings with Withdrawal Sleeve

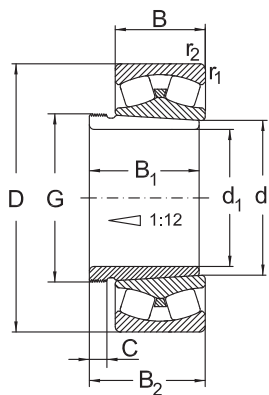

CK + AH...

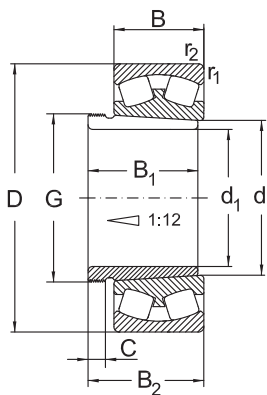

MBK + AH...

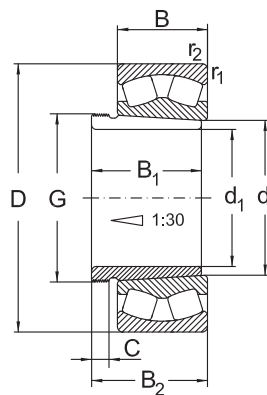

CAK30 + AH...

Dimensions					Designation		Basical radial load		Speed limit	
d <sub>1</sub>	d	D	B	r <sub>1</sub> , r <sub>2</sub> min.	Bearing	Withdrawal Sleeve	dyn. C <sub>r</sub>	stat. C <sub>0r</sub>	grease	oil
mm							kN		min <sup>-1</sup>	
125	130	230	64	3	22226 CKW33	AHX3126	660	960	1700	2200
	130	230	80	3	23226 CKW33	AHX3226	830	1270	1300	1700
	130	280	93	4	22326 MBKW33	AHX2326	1080	1450	1100	1400
135	140	210	53	2	23028 CKW33	AHX3028	475	820	1700	2200
	140	210	69	2	24028 CK30W33	AH24028	550	990	1100	1500
	140	225	68	2,1	23128 MBKW33	AHX3128	600	990	1400	1800
	140	225	85	2,1	24128 CK30W33	AH24128	740	1380	1100	1500
	140	250	68	3	22228 CKW33	AHX3128	730	1080	1400	1900
	140	250	88	3	23228 CKW33	AHX3228	960	1500	1100	1400
	140	300	102	4	22328 MBKW33	AHX2328	1240	1720	1000	1300
145	150	225	56	2,1	23030 CKW33	AHX3030	520	900	1500	2000
	150	225	75	2,1	24030 CK30W33	AH24030	620	1140	1300	1700
	150	250	80	2,1	23130 MBKW33	AHX3130	800	1320	1300	1700
	150	250	100	2,1	24130 CK30W33	AH24130	915	1560	1100	1500
	150	270	73	3	22230 CKW33	AHX3130	880	1300	1400	1800
	150	270	96	3	23230 CKW33	AHX3230	1090	1750	1100	1400
	150	320	108	4	22330 MBKW33	AHX2330	1400	1940	1000	1300
150	160	240	60	2,1	23032 CKW33	AH3032	610	1060	1400	1900
	160	240	80	2,1	24032 CK30W33	AH24032	720	1320	1000	1300

## Spherical Roller Bearings with Withdrawal Sleeve

Abutment and fillet dimensions  
see on page 318

Dimensions									Mass	
d <sub>1</sub>	B <sub>1</sub>	B <sub>2</sub>	C	G	e	y <sub>1</sub>	y <sub>2</sub>	y <sub>0</sub>	Bearing	Withdrawal Sleeve
mm									kg	
125	78	82	12	M140X2	0,29	2,3	3,5	2,3	10,87	1,1
	98	102	15	M145X2	0,33	2	3	2	15,80	1,55
	115	119	19	M145X2	0,37	1,8	2,7	1,8	28,77	2
135	68	73	14	M150X2	0,22	3	4,6	2,8	7,03	1
	83	93	14	M145X2	0,29	2,3	3,5	2,3	9,06	0,95
	83	88	14	M150X2	0,3	2,3	3,3	2,2	10,38	1,3
	99	109	14	M150X2	0,34	2	2,9	1,9	14,1	1,3
	83	88	14	M150X2	0,26	2,6	3,9	2,5	14,09	1,3
	104	109	15	M155X3	0,33	2	3	2	20,8	1,85
	125	130	20	M155X2	0,38	1,7	2,6	1,7	34,57	2,35
145	72	77	15	M160X3	0,22	3	4,6	2,8	8,4	1,15
	90	101	15	M155X3	0,29	2,3	3,5	2,3	11,2	1,05
	96	101	15	M165X3	0,32	2,1	3,2	2,1	16	1,8
	115	126	15	M160X3	0,4	1,7	2,5	1,6	21,5	1,55
	96	101	15	M165X3	0,26	2,6	3,9	2,5	18,23	1,8
	114	119	17	M165X3	0,4	2,1	2,5	1,8	24,7	2,2
	135	140	24	M165X3	0,38	1,7	2,6	1,7	41,35	2,8
150	77	82	16	M170X3	0,22	3	4,6	2,8	9,71	2,05
	95	106	15	M170X3	0,29	2,3	3,4	2,3	14,6	2,3



### Spherical Roller Bearings with Withdrawal Sleeve

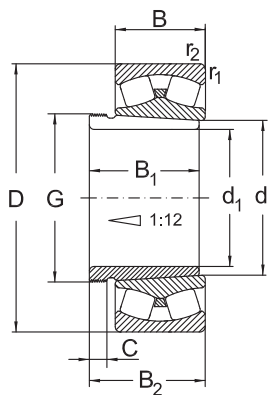

CK + AH...

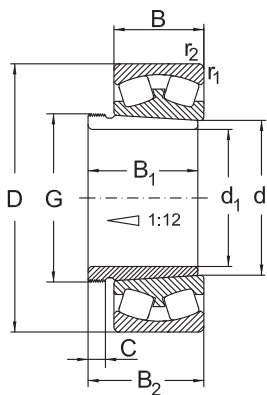

MBK + AH...

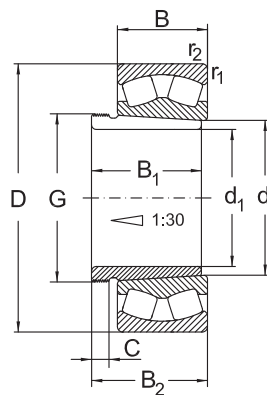

CAK30 + AH...

Dimensions					Designation		Basical radial load		Speed limit	
d <sub>1</sub>	d	D	B	r <sub>1</sub> , r <sub>2</sub> min.	Bearing	Withdrawal Sleeve	dyn. C <sub>r</sub>	stat. C <sub>0r</sub>	grease	oil
mm							kN		min <sup>-1</sup>	
150	160	270	86	2,1	23132 MBKW33	AH3132	930	1510	1200	1600
	160	270	109	2,1	24132 CK30W33	AH24132	1250	2110	850	1100
	160	290	80	3	22232 CKW33	AH3132	1040	1550	1300	1700
	160	290	104	3	23232 CKW33	AH3232	1210	1900	1000	1400
	160	340	114	4	22332 MBKW33	AH2332	1520	2160	900	1200
160	170	260	67	2,1	23034 CKW33	AH3034	750	1270	1400	1800
	170	260	90	2,1	24034 MBK30W33	AH24034	880	1610	1000	1300
	170	280	88	2,1	23134 MBKW33	AH3134	990	1650	1100	1500
	170	280	109	2,1	24134 CK30W33	AH24134	1060	1830	850	1100
	170	310	86	4	22234 CKW33	AH334	1170	1750	1200	1600
	170	310	110	4	23234 CKW33	AH2334	1500	2350	950	1250
	170	360	120	4	22334 MBKW33	AH2334	1690	2380	850	1100
170	180	280	74	2,1	23036 CKW33	AH3036	870	1500	1300	1700
	180	280	100	2,1	24036 MBK30W33	AH24036	900	1750	900	1200
	180	300	96	3	23136 CKW33	AH3136	1260	2110	1200	1600
	180	300	118	3	24136 CK30W33	AH24136	1320	2360	700	950
	180	320	86	4	22236 CKW33	AH2236	1210	1870	1100	1500
	180	320	112	4	23236 CKW33	AH3236	1420	2320	750	1000
	180	380	126	4	22336 MBKW33	AH2336	1860	2500	850	1100

## Spherical Roller Bearings with Withdrawal Sleeve

Abutment and fillet dimensions  
see on page 318

Dimensions									Mass	
d <sub>1</sub>	B <sub>1</sub>	B <sub>2</sub>	C	G	e	y <sub>1</sub>	y <sub>2</sub>	y <sub>0</sub>	Bearing	Withdrawal Sleeve
mm									kg	
<b>150</b>	103	108	16	M180X3	0,32	2,1	3,2	2,1	20,7	2,87
	124	135	15	M170X3	0,39	1,7	2,5	1,6	24,8	3,05
	103	108	16	M180X3	0,26	2,6	3,9	2,5	24,7	2,87
	124	130	20	M180X3	0,3	2,3	3,4	2,2	32,7	4
	140	146	24	M180X3	0,37	1,8	2,7	1,8	49,16	4,72
<b>160</b>	85	90	17	M180X3	0,23	2,9	4,4	2,8	13,95	2,4
	106	117	16	M180X3	0,34	2	3	2	17,3	2,7
	104	109	16	M190X3	0,31	2,2	3,2	2,1	21,46	3,04
	125	136	16	M180X3	0,39	1,7	2,6	1,7	29,6	3,25
	104	109	16	M190X3	0,27	2,5	3,7	2,5	32	3,04
	134	140	24	M190X3	0,35	1,9	2,9	1,8	34,75	4,8
	146	152	24	M190X3	0,37	1,8	2,7	1,8	57,53	5,25
<b>170</b>	92	98	17	M190X3	0,24	2,8	4,2	2,8	18,36	2,8
	116	127	16	M190X3	0,36	1,9	2,8	1,9	22,42	3,2
	116	122	19	M 200X3	0,3	2,3	3,4	2,2	29,38	3,76
	134	145	16	M190X3	0,4	1,7	2,5	1,6	33,32	3,68
	105	110	17	M 200X3	0,26	2,6	3,9	2,5	32,58	5,25
	140	146	25	M 200x3	0,36	1,9	2,8	1,8	38,36	5,32
	154	160	26	M 200x3	0,37	1,8	2,7	1,8	66,451	5,83



### Spherical Roller Bearings with Withdrawal Sleeve

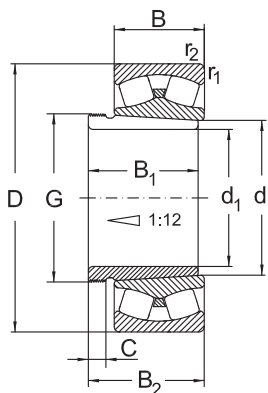

CK + AH...

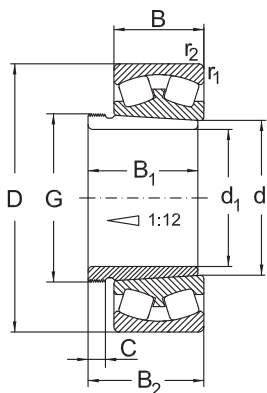

MBK + AH...

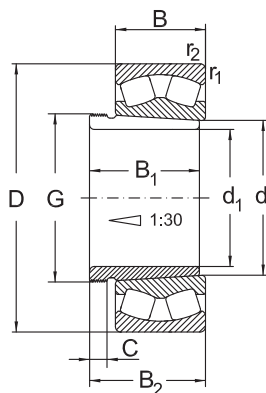

CAK30 + AH...

Dimensions					Designation		Basic radial load		Speed limit	
d <sub>1</sub>	d	D	B	r <sub>1</sub> , r <sub>2</sub> min.	Bearing	Withdrawal Sleeve	dyn. C <sub>r</sub>	stat. C <sub>0r</sub>	grease	oil
mm							kN		min <sup>-1</sup>	
180	190	290	75	2,1	23038 CKW33	AH3038	915	1530	1300	1700
	190	290	100	2,1	24038 MBK30W33	AH24038	980	1810	850	1100
	190	320	104	3	23138 MBKW33	AH3138	1320	2290	1100	1400
	190	320	128	3	24138 CK30W33	AH24138	1400	2500	670	900
	190	340	92	4	22238 CKW33	AH2238	1330	2040	1100	1400
	190	340	120	4	23238 CKW33	AH3238	1750	2880	850	1100
	190	400	132	5	22338 MBKW33	AH2338	1900	2700	750	1000
190	200	310	82	2,1	23040 CKW33	AH3040	1060	1760	1300	1700
	200	310	109	2,1	24040 MBK30W33	AH24040	1100	2200	750	1000
	200	340	112	3	23140 MBKW33	AH3140	1370	2460	1100	1400
	200	340	140	3	24140 CK30W33	AH24140	1700	3000	800	1000
	200	360	98	4	22240 CKW33	AH2240	1250	2020	1100	1400
	200	360	128	4	23240 CKW33	AH3240	1620	2590	750	1000
	200	420	138	5	22340 MBKW33	AH2340	1910	2750	670	900
200	220	340	90	3	23044 MBKW33	AH3044	1025	1730	900	1200
	220	340	118	3	24044 K30W33	AH24044	1370	2600	750	950
	220	370	150	4	24144 K30W33	AH24144	1800	3300	700	900
	220	370	120	4	23144 MBKW33	AH3144	1515	2509	1000	1300
	220	400	108	4	22244 CKW33	AH3144	1545	2300	900	1200

## Spherical Roller Bearings with Withdrawal Sleeve

Abutment and fillet dimensions  
see on page 318

Dimensions									Mass	
d <sub>1</sub>	B <sub>1</sub>	B <sub>2</sub>	C	G	e	y <sub>1</sub>	y <sub>2</sub>	y <sub>0</sub>	Bearing	Withdrawal Sleeve
mm									kg	
<b>180</b>	96	102	18	Tr 205x4	0,23	3	4,4	2,9	15,8	3,32
	118	131	18	M 200x3	0,34	2	3	2	24	3,55
	125	131	20	Tr 210x4	0,33	2	3	2	36,09	4,9
	146	159	18	M 200x3	0,41	1,7	2,5	1,6	46,2	4,28
	112	117	18	Tr 210x4	0,26	2,6	3,9	2,5	36,8	4,25
	145	152	25	Tr 210x4	0,35	1,9	2,9	1,8	52,4	5,9
	160	167	26	Tr 210x4	0,37	1,8	2,7	1,8	80,5	6,63
<b>190</b>	102	108	19	Tr 215x4	0,23	2,9	4,3	2,8	21,8	3,85
	127	140	18	Tr 210x4	0,35	1,9	2,9	1,9	29,7	4
	134	140	21	Tr 220x4	0,35	1,9	2,9	1,9	43,5	5,49
	158	171	18	Tr 210x4	0,14	1,6	2,4	1,6	52,5	5,05
	118	223	19	Tr 220x4	0,29	2,3	3,9	2,3	44,4	4,7
	153	160	24	Tr 220x4	0,35	1,9	2,9	1,8	58,4	6,6
	170	177	30	Tr 220x4	0,36	1,8	2,8	1,8	91,8	7,6
<b>200</b>	111	117	20	Tr 235x4	0,26	2,6	3,8	2,5	31	7,4
	138	152	20	Tr 230x4	0,34	2	2,9	1,9	49	8,2
	170	164	20	Tr 230x4	0,41	1,6	2,4	1,6	75,5	10
	145	151	23	Tr 240x4	0,3	2,3	3,4	2,2	52	10,4
	145	151	23	Tr 240x4	0,29	2,3	3,4	2,3	61,4	9,3



### Spherical Roller Bearings with Withdrawal Sleeve

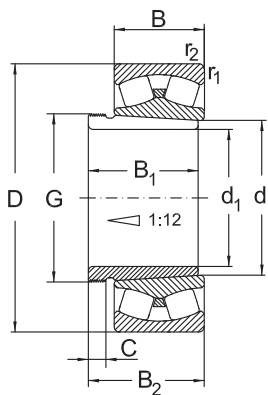

CK + AH...

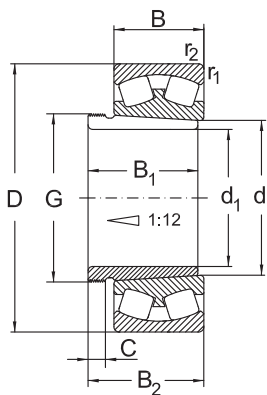

MBK + AH...

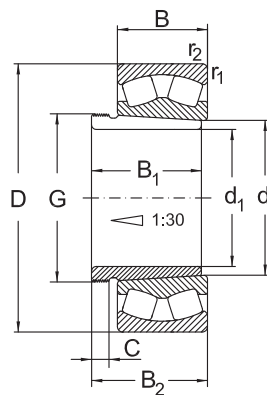

CAK30 + AH...

Dimensions					Designation		Basical radial load		Speed limit	
d <sub>1</sub>	d	D	B	r <sub>1</sub> , r <sub>2</sub> min.	Bearing	Withdrawal Sleeve	dyn. C <sub>r</sub>	stat. C <sub>0r</sub>	grease	oil
mm							kN		min <sup>-1</sup>	
200	220	400	144	4	<b>23244 CKW33</b>	<b>AH2344</b>	2065	3380	670	900
	220	460	145	5	<b>22344 CKW33</b>	<b>AH2344</b>	2380	3407	700	950
220	240	360	92	3	<b>23048 MBKW33</b>	<b>AH3048</b>	1090	1960	800	1000
	240	360	118	3	<b>24048 K30W33</b>	<b>AH24048</b>	1460	2841	700	900
	240	400	160	4	<b>24148 K30W33</b>	<b>AH24148</b>	2120	3780	670	850
	240	400	128	4	<b>23148 MBKW33</b>	<b>AH3148</b>	1705	2863	900	1200
	240	440	120	4	<b>22248 CKW33</b>	<b>AH3148</b>	1845	2763	850	1100
	240	440	160	4	<b>23248 CKW33</b>	<b>AH2348</b>	2530	4600	630	850
	240	500	155	5	<b>22348 MBKW33</b>	<b>AH2348</b>	2650	4000	560	750
240	260	400	104	4	<b>23052 MBKW33</b>	<b>AH3052</b>	1500	2800	750	950
	260	400	140	4	<b>24052 K30W33</b>	<b>AH24052</b>	1875	3794	630	800
	260	440	180	4	<b>24152 K30W33</b>	<b>AH24152</b>	2652	5080	600	750
	260	440	144	4	<b>23152 MBKW33</b>	<b>AH3152</b>	2153	3673	850	1100
	260	480	130	5	<b>22252 MBKW33</b>	<b>AH2252</b>	2190	3300	750	1000
	260	540	165	6	<b>22352 CKW33</b>	<b>AH2352</b>	3125	4560	600	800
260	280	420	106	4	<b>23056 MBKW33</b>	<b>AH3056</b>	1560	3000	700	900
	280	420	140	4	<b>24056 K30W33</b>	<b>AH24056</b>	2000	4000	560	750
	280	460	146	5	<b>23156 MBKW33</b>	<b>AH3156</b>	2295	4050	750	1000
	280	460	180	5	<b>24156 K30W33</b>	<b>AH24156</b>	2685	5148	400	530



## Spherical Roller Bearings with Withdrawal Sleeve

Abutment and fillet dimensions  
see on page 318

Dimensions									Mass	
d <sub>1</sub>	B <sub>1</sub>	B <sub>2</sub>	C	G	e	y <sub>1</sub>	y <sub>2</sub>	y <sub>0</sub>	Bearing	Withdrawal Sleeve
mm									kg	
200	181	189	30	Tr 240x4	0,35	1,9	2,9	1,8	79,5	13,5
	181	189	30	Tr 240x4	0,36	1,8	2,8	1,8	120	13,5
220	116	123	21	Tr 260x4	0,25	2,7	4,1	2,7	33,9	8,75
	138	153	20	Tr 250x4	0,32	2,1	3,1	2,1	52,6	9
	180	195	20	Tr 260x4	0,41	1,7	2,5	1,6	93,1	12,5
	154	161	25	Tr 260x4	0,3	2,3	3,4	2,2	66	12
	154	161	25	Tr 260x4	0,29	2,3	3,4	2,3	83,2	12
	189	197	30	Tr 260x4	0,35	1,9	2,9	1,8	109	15,5
240	189	197	30	Tr 260x4	0,31	2,2	3,3	2,2	151	15,5
	128	135	23	Tr 280x4	0,26	2,6	3,9	2,6	49	10,7
	162	178	22	Tr 270x4	0,35	1,9	2,9	1,9	77,8	11,8
	202	218	22	Tr 280x4	0,42	1,6	2,4	1,6	129	15,4
	172	179	26	Tr 290x4	0,31	2,2	3,3	2,2	92,5	16
	155	179	26	Tr 290x4	0,29	2,3	3,4	2,3	107	12,5
260	205	213	30	Tr 290x4	0,36	1,8	2,8	1,8	187	19,6
	131	139	24	Tr 300x4	0,25	2,7	4,1	2,7	52,5	12
	162	179	22	Tr 290x4	0,33	2	3	2	83,1	12,8
	175	183	28	Tr 310x5	0,3	2,3	3,4	2,2	98,5	17,5
	202	219	22	Tr 300x4	0,39	1,7	2,5	1,7	134	16,3



### Spherical Roller Bearings with Withdrawal Sleeve

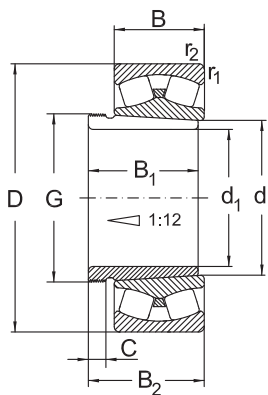

CK + AH...

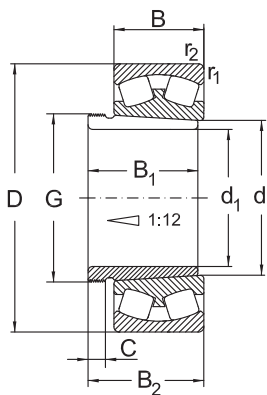

MBK + AH...

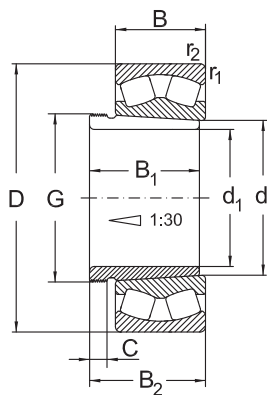

CAK30 + AH...

Dimensions					Designation		Basic radial load		Speed limit	
d <sub>1</sub>	d	D	B	r <sub>1</sub> , r <sub>2</sub> min.	Bearing	Withdrawal Sleeve	dyn. C <sub>r</sub>	stat. C <sub>0r</sub>	grease	oil
mm							kN		min <sup>-1</sup>	
260	280	500	176	5	<b>23256 MBKW33</b>	<b>AH2356</b>	2806	4645	480	630
	280	580	175	6	<b>22356 CKW33</b>	<b>AH2356</b>	3530	5208	560	750
280	300	460	118	4	<b>23060 MBKW33</b>	<b>AH3060</b>	1960	3650	630	800
	300	460	160	4	<b>24060 K30W33</b>	<b>AH24060</b>	2385	4702	560	700
	300	500	160	5	<b>23160 MBKW33</b>	<b>AH3160</b>	2385	4485	700	950
	300	500	200	5	<b>24160 K30W33</b>	<b>AH24160</b>	3213	6011	430	560
300	320	480	121	4	<b>23064 MBKW33</b>	<b>AH3064</b>	2040	4000	600	750
	320	480	160	4	<b>24064 K30W33</b>	<b>AH24064</b>	2500	5240	530	670
	320	540	176	5	<b>23164 MBKW33</b>	<b>AH3164</b>	3115	6000	530	670
	320	540	218	5	<b>24164 K30W33</b>	<b>AH24164</b>	3750	7300	400	530
	320	580	208	5	<b>23264 MBKW33</b>	<b>AH3264</b>	4130	7026	430	560
320	340	520	133	5	<b>23068 CAKW33</b>	<b>AH3068</b>	2360	4500	560	700
	340	520	180	5	<b>24068 CAK30W33</b>	<b>AH24068</b>	2912	5961	480	600
	340	580	190	5	<b>23168 CAKW33</b>	<b>AH3168</b>	3740	6640	630	850
	340	580	243	5	<b>24168 CAK30W33</b>	<b>AH24168</b>	4400	8500	450	560
340	360	540	134	5	<b>23072 CAKW33</b>	<b>AH3072</b>	2450	4800	530	670
	360	540	180	5	<b>24072 CAK30W33</b>	<b>AH24072</b>	3150	6530	480	630
	360	600	192	5	<b>23172 CAKW33</b>	<b>AH3172</b>	3810	7010	600	800
	360	600	243	5	<b>24172 CAK30W33</b>	<b>AH24172</b>	4500	9000	430	530

## Spherical Roller Bearings with Withdrawal Sleeve

Abutment and fillet dimensions  
see on page 318

Dimensions									Mass	
d <sub>1</sub>	B <sub>1</sub>	B <sub>2</sub>	C	G	e	y <sub>1</sub>	y <sub>2</sub>	y <sub>0</sub>	Bearing	Withdrawal Sleeve
mm									kg	
260	212	220	30	Tr 310x5	0,35	1,9	2,9	1,8	153	21,6
	212	220	30	Tr 310x5	0,36	1,8	2,8	1,8	235	21,6
280	145	153	26	Tr 320x5	0,25	2,7	4	2,6	73,6	14,4
	184	202	24	Tr 310x5	0,35	2	2,9	1,9	116	15,5
	192	200	30	Tr 330x5	0,3	2,3	3,4	2,2	129	20,8
	224	242	24	Tr 320x5	0,4	1,7	2,5	1,6	179	19,5
300	149	157	27	Tr 345x5	0,25	2,7	4,1	2,7	79,5	16
	184	202	24	Tr 330x5	0,33	2,1	3,1	2	123	16,6
	209	217	31	Tr 350x5	0,34	2	3	1,9	165	24,5
	242	260	24	Tr 340x5	0,41	1,7	2,5	1,6	225	21,4
	246	254	36	Tr 350x5	0,35	1,9	2,9	1,8	247	30,6
320	162	171	28	Tr 365x5	0,25	2,7	4	2,6	101	19,5
	206	225	26	Tr 360x5	0,34	2	2,9	1,9	143	21,7
	225	234	33	Tr 370x5	0,31	2,2	3,2	2,2	212	29
	269	288	26	Tr 360x5	0,43	1,6	2,3	1,5	260	27,1
340	167	176	30	Tr 385x5	0,25	2,7	4,1	2,7	107	21
	206	226	26	Tr 380x5	0,33	2,1	3,1	2	136	20
	229	238	35	Tr 400x5	0,33	2,3	3,4	2,2	217	33
	269	289	26	Tr 380x5	0,41	1,6	2,4	1,6	275	29,6



### Spherical Roller Bearings with Withdrawal Sleeve

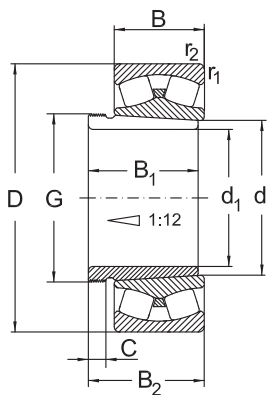

CK + AH...

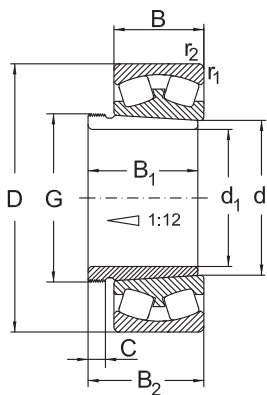

MBK + AH...

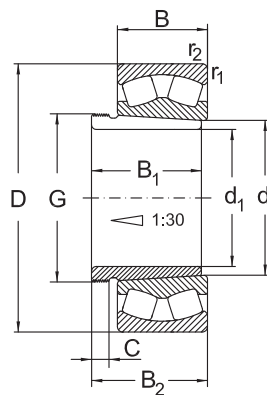

CAK30 + AH...

Dimensions					Designation		Basic radial load		Speed limit	
d <sub>1</sub>	d	D	B	r <sub>1</sub> , r <sub>2</sub> min.	Bearing	Withdrawal Sleeve	dyn. C <sub>r</sub>	stat. C <sub>0r</sub>	grease	oil
mm							kN		min <sup>-1</sup>	
<b>340</b>	360	650	232	6	<b>23272 CAKW33</b>	<b>AH3272</b>	4880	8490	430	560
<b>360</b>	380	560	135	5	<b>23076 CAKW33</b>	<b>AH3076</b>	2550	5300	500	630
	380	560	180	5	<b>24076 CAK30W33</b>	<b>AH24076</b>	3150	6710	450	600
	380	620	194	5	<b>23176 CAKW33</b>	<b>AH3176</b>	3890	7540	560	750
	380	620	243	5	<b>24176 CAK30W33</b>	<b>AH24176</b>	4650	9500	400	500
	380	680	240	6	<b>23276 CAKW33</b>	<b>AH3276</b>	5050	9660	400	530
<b>380</b>	400	600	148	5	<b>23080 CAKW33</b>	<b>AH3080</b>	3050	6200	450	560
	400	600	200	5	<b>24080 CAK30W33</b>	<b>AH24080</b>	3610	7545	430	460
	400	650	200	6	<b>23180 CAKW33</b>	<b>AH3180</b>	4500	7900	530	700
	400	650	250	6	<b>24180 CAK30W33</b>	<b>AH24180</b>	5100	10400	380	480
	400	720	256	6	<b>23280 CAKW33</b>	<b>AH3280</b>	5950	10807	380	500
<b>400</b>	420	620	150	5	<b>23084 CAKW33</b>	<b>AH3084</b>	3150	6550	450	560
	420	620	200	5	<b>24084 CAK30W33</b>	<b>AH24084</b>	4000	8800	380	480
	420	700	224	6	<b>23184 CAKW33</b>	<b>AH3184</b>	4600	9000	500	670
	420	700	280	6	<b>24184 CAK30W33</b>	<b>AH24184</b>	6200	12700	400	500
	420	760	272	7,5	<b>23284 CAKW33</b>	<b>AH3284</b>	6575	11717	360	480
<b>420</b>	440	650	157	6	<b>23088 CAKW33</b>	<b>AHX3088</b>	3400	7100	430	530
	440	650	212	6	<b>24088 CAK30W33</b>	<b>AHX24088</b>	4300	9650	360	450
	440	720	226	6	<b>23188 CAKW33</b>	<b>AHX3188</b>	5250	10000	500	670

## Spherical Roller Bearings with Withdrawal Sleeve

Abutment and fillet dimensions  
see on page 318

Dimensions									Mass	
d <sub>1</sub>	B <sub>1</sub>	B <sub>2</sub>	C	G	e	y <sub>1</sub>	y <sub>2</sub>	y <sub>0</sub>	Bearing	Withdrawal Sleeve
mm									kg	
<b>340</b>	274	283	40	Tr 400x5	0,35	1,9	2,9	1,8	328	41,5
<b>360</b>	170	180	31	Tr 410x5	0,25	2,8	4,2	2,8	113	23,5
	208	228	28	Tr 400x5	0,31	2,2	3,2	2,1	155	23,5
	232	242	36	Tr 420x5	0,3	2,3	3,4	2,2	240	36
	271	291	28	Tr 400x5	0,39	1,7	2,5	1,7	277	31
	284	294	42	Tr 420x5	0,35	1,9	2,9	1,8	367	45,5
<b>380</b>	183	193	33	Tr 430x5	0,24	2,8	4,1	2,7	143	27
	228	248	28	Tr 420x5	0,33	2,1	3,1	2	196	27
	240	250	38	Tr 440x5	0,28	2,4	3,6	2,5	261	39
	278	298	28	Tr 420x5	0,39	1,7	2,6	1,7	312	35
	302	312	44	Tr 440x5	0,35	1,9	2,9	1,8	442	51,5
<b>400</b>	186	196	34	Tr 450x5	0,24	2,8	4,2	2,8	155	29
	230	252	30	Tr 440x5	0,32	2,1	3,2	2,1	214	29
	266	276	40	Tr 460x5	0,33	2	3	2	339	46
	310	332	30	Tr 440x5	0,33	2	3	2	407	40,3
	321	331	46	Tr 460x5	0,35	1,9	2,9	1,8	537	58,9
<b>420</b>	194	205	35	Tr 470x5	0,24	2,8	4,2	2,8	177	32
	242	264	30	Tr 460x5	0,32	2,1	3,2	2,1	247	32
	270	281	42	Tr 480x5	0,3	2,3	3,4	2,2	378	49,8



### Spherical Roller Bearings with Withdrawal Sleeve

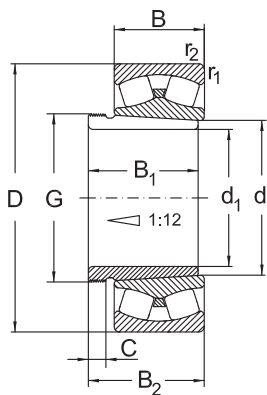

CK + AH...

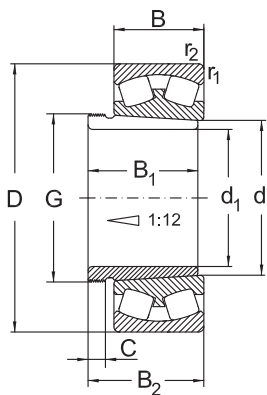

MBK + AH...

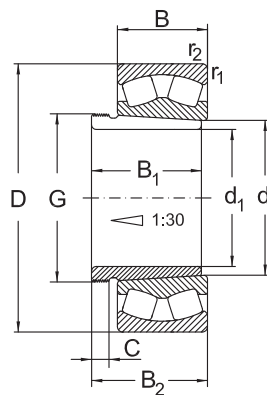

CAK30 + AH...

Dimensions					Designation		Basic radial load		Speed limit	
d <sub>1</sub>	d	D	B	r <sub>1</sub> , r <sub>2</sub> min.	Bearing	Withdrawal Sleeve	dyn. C <sub>r</sub>	stat. C <sub>0r</sub>	grease	oil
mm							kN		min <sup>-1</sup>	
420	440	720	280	6	<b>24188 CAK30W33</b>	<b>AHX24188</b>	6400	13200	340	430
	440	790	280	7,5	<b>23288 CAKW33</b>	<b>AHX3288</b>	7100	13400	360	480
440	460	680	163	6	<b>23092 CAKW33</b>	<b>AHX3092</b>	3650	7650	400	500
	460	760	240	7,5	<b>23192 CAKW33</b>	<b>AHX3192</b>	5760	11025	480	630
	460	760	300	7,5	<b>24192 CAK30W33</b>	<b>AH24192</b>	7500	15600	320	400
	460	830	296	7,5	<b>23292 CAKW33</b>	<b>AHX3292</b>	7560	13970	340	450
460	480	700	165	6	<b>23096 CAKW33</b>	<b>AHX3096</b>	3800	8150	380	480
	480	790	248	7,5	<b>23196 CAKW33</b>	<b>AHX3196</b>	5800	11800	450	600
	480	790	308	7,5	<b>24196 CAK30W33</b>	<b>AH24196</b>	8000	16600	320	400
	480	870	310	7,5	<b>23296 CAKW33</b>	<b>AHX3296</b>	8800	17000	340	430
480	500	670	128	5	<b>239/500 CAKW33</b>	<b>AH39/500</b>	2500	6090	480	630
	500	720	167	6	<b>230/500 CAKW33</b>	<b>AHX30/500</b>	3900	8500	380	480
	500	830	264	7,5	<b>231/500 CAKW33</b>	<b>AHX31/500</b>	6550	13200	430	560
	500	830	325	7,5	<b>241/500 CAK30W33</b>	<b>AH241/500</b>	8650	18300	300	380
	500	920	336	7,5	<b>232/500 CAKW33</b>	<b>AHX32/500</b>	9650	18300	320	400
500	530	710	136	5	<b>239/530 CAKW33</b>	<b>AH39/530</b>	2980	6755	450	600
	530	780	185	6	<b>230/530 CAKW33</b>	<b>AH30/530</b>	4400	9500	340	430
	530	870	335	7,5	<b>241/530 CAK30W33</b>	<b>AH241/530</b>	9500	20000	280	360
530	560	750	140	5	<b>239/560 CAKW33</b>	<b>AH39/560</b>	3100	7650	340	430

## Spherical Roller Bearings with Withdrawal Sleeve

Abutment and fillet dimensions  
see on page 318

Dimensions									Mass	
d <sub>1</sub>	B <sub>1</sub>	B <sub>2</sub>	C	G	e	y <sub>1</sub>	y <sub>2</sub>	y <sub>0</sub>	Bearing	Withdrawal Sleeve
mm									kg	
420	310	332	30	Tr 460x5	0,38	1,8	2,6	1,7	451	42,5
	330	341	48	Tr 480x5	0,35	1,9	2,9	1,8	586	63,8
440	202	213	37	Tr 490x5	0,24	2,8	4,2	2,8	204	35,2
	285	296	43	Tr 510x6	0,3	2,3	3,4	2,2	420	57,9
	332	355	32	Tr 480x6	0,39	1,7	2,6	1,7	578	50
	349	360	50	Tr 510x6	0,35	1,9	2,9	1,9	685	74,5
460	205	217	38	Tr 520x6	0,23	2,9	4,3	2,8	208	39,2
	295	307	45	Tr 530x6	0,3	2,3	3,4	2,2	470	63,1
	340	363	32	Tr 500x6	0,39	1,8	2,6	1,7	700	51,5
	364	376	52	Tr 530x6	0,37	1,8	2,7	1,8	806	82,1
480	162	172	32	Tr 520x6	0,17	3,9	5,8	3,8	124	28
	209	221	40	Tr 540x6	0,22	3	4,5	2,9	219	42,5
	313	325	47	Tr 550x6	0,3	2,3	3,4	2,2	556	70,9
	360	383	35	Tr 530x6	0,39	1,7	2,6	1,7	717	57
	393	405	54	Tr 550x6	0,38	1,8	2,7	1,7	985	94,6
500	175	185	37	Tr 550x6	0,18	3,8	5,7	3,8	146	43,4
	230	242	45	Tr 560x6	0,22	3	4,5	3	291	61,9
	370	394	35	Tr 550x6	0,38	1,8	2,6	1,7	830	86
530	180	190	37	Tr 580x6	0,17	4	5,9	3,9	169	47,4



### Spherical Roller Bearings with Withdrawal Sleeve

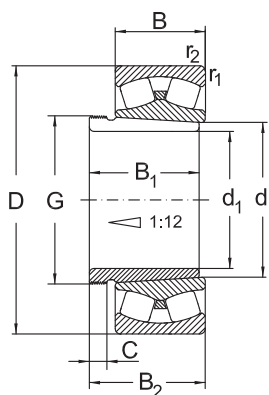

CK + AH...

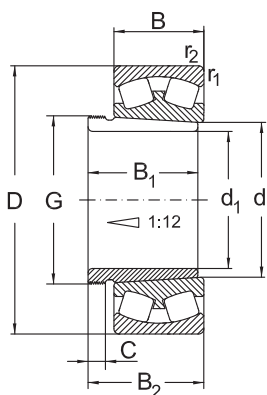

MBK + AH...

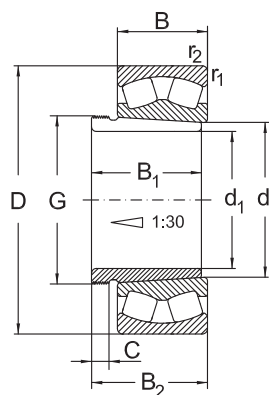

CAK30 + AH...

Dimensions					Designation		Basic radial load		Speed limit	
d <sub>1</sub>	d	D	B	r <sub>1</sub> , r <sub>2</sub> min.	Bearing	Withdrawal Sleeve	dyn. C <sub>r</sub>	stat. C <sub>0r</sub>	grease	oil
mm							kN		min <sup>-1</sup>	
530	560	820	195	6	<b>230/560 CAKW33</b>	<b>AH30/560</b>	5100	11000	320	400
	560	920	355	7,5	<b>241/560 CAK30W33</b>	<b>AH241/560</b>	10600	22400	260	340
570	600	800	150	5	<b>239/600 CAKW33</b>	<b>AH39/600</b>	3450	8650	320	400
	600	870	200	6	<b>230/600 CAKW33</b>	<b>AH30/600</b>	5700	12500	300	380
	600	980	375	7,5	<b>241/600 CAK30W33</b>	<b>AH241/600</b>	11600	26000	240	320
600	630	850	165	6	<b>239/630 CAKW33</b>	<b>AH39/630</b>	4290	9910	380	500
	630	920	212	7,5	<b>230/630 CAKW33</b>	<b>AH30/630</b>	6300	14000	260	340
630	670	900	170	6	<b>239/670 CAKW33</b>	<b>AH39/670</b>	4300	10600	280	360
	670	980	230	7,5	<b>230/670 CAKW33</b>	<b>AH30/670</b>	7200	16000	260	340
670	710	950	180	6	<b>239/710 CAKW33</b>	<b>AH39/710</b>	4800	12000	260	340
710	750	950	185	6	<b>239/750 CAKW33</b>	<b>AH39/750</b>	5200	12900	260	340



## Spherical Roller Bearings with Withdrawal Sleeve

Abutment and fillet dimensions  
see on page 318

Dimensions									Mass	
$d_1$	$B_1$	$B_2$	C	G	e	$y_1$	$y_2$	$y_0$	Bearing	Withdrawal Sleeve
mm									kg	
<b>530</b>	240	252	45	Tr 590x6	0,23	2,9	4,4	2,9	339	68,6
	393	417	38	Tr 580x6	0,38	1,8	2,6	1,7	974	97
<b>560</b>	192	202	38	Tr 625x6	0,17	4	5,9	3,9	210	56,1
	245	259	45	Tr 630x6	0,22	3,1	4,6	3	388	75,4
	413	439	38	Tr 630x6	0,38	1,8	2,7	1,8	1170	120
<b>600</b>	210	232	40	Tr 655x6	0,18	3,8	5,7	3,7	283	62,8
	258	272	46	Tr 670x6	0,31	2,2	3,3	2,2	496	87,7
<b>630</b>	216	228	41	Tr 695x6	0,17	4	5,9	3,9	310	85,5
	280	294	50	Tr 710x7	0,22	3	4,5	2,9	590	124
<b>670</b>	228	240	43	Tr 740x7	0,18	3,8	5,7	3,8	336	102
<b>710</b>	234	246	44	Tr 780x7	0,17	4	5,9	3,9	394	111



## Spherical Roller Bearings Non standardized

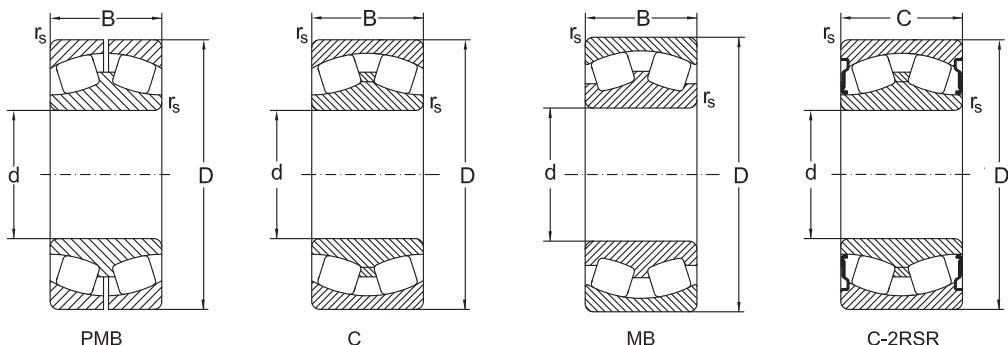

Dimensions					Basical radial load						Speed limit		Designation	Mass	
d	D	B	C	$r_s$ min.	dyn. $C_r$	e	$y_1$	$y_2$	stat. $C_{or}$	$y_0$	grease	oil	Bearing		kg
mm					kN						min <sup>-1</sup>				
50	90	23	28	1,1	100				120					22210/B28 C-2RSR	0,783
55	100	25	31	1,5	120				140					22211/B31 C-2RSR	1,045
80	140	33	40	2	210				275					22216/B40 C-2RSR	2,364
90	160	40	48	2	305				410					22218/B48 C-2RSR	3,98
100	180	46	55	2,1	375				500					22220/B55 C-2RSR	5,967
100	162	62	62	3	312				479		1400	1700		25120 MB	5,44
130	220	73	73	2	500	0,31	2,2	3,3	995	2,2	1100	1400		25326 C	11,4
	240	80	80	3	572	0,33	2	3	1104	2	1100	1400		25126 MBK	15,3
131,796	220	73	73	2	470	0,31	2,2	3,3	1020	2,2	1100	1400		25226 C	11,2
	220	73	73	2	470	0,31	2,2	3,3	1020	2,2	1100	1400		25226 CW33	11,2
	220	73	73	2	470				1020		1100	1400		25226 CY	11,2
140	240	80	80	3	482	0,26	2,6	3,9	1030	2,5	950	1300		28228 PMB	19,9
	260	86	86	3	663	0,26	2,6	3,9	1288	2,5	950	1300		25128 MBK	19,9
144,475	250	80	80	2	625	0,33	2	3	1310	2	900	1200		25129 C	16,5
169	310	110	110	3	1228				1970		1200	1400		25134 C	36,3

## Spherical Roller Bearings Non standardized

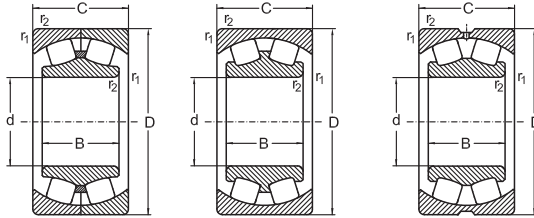

Fig. 4

Fig. 5

Fig. 6

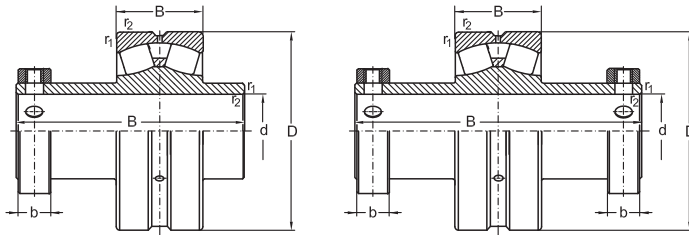

Fig. 7

Fig. 8

Dimensions						Fig.	Basical radial load		Designation	Mass
d	D	B	C	$r_{s1}, r_{1s}$ min.	b		dyn, $C_i$	stat, $C_{0r}$	Bearing	
mm							kN			kg
<b>38,1</b>	80	23	69,85	1,1	15,88	<b>7</b>	88	98	<b>SB1000 1-1/2</b>	0,93
<b>42,877</b>	85	23	73	1	15,9	<b>7</b>	131,5	188	<b>SB1000 1-11/16</b>	1,16
<b>49,21</b>	90	23	73	1,1	15,88	<b>7</b>	100	120	<b>SB1000 1-15/16</b>	1,23
<b>61,93</b>	120	31	85,75	1,5	22,3	<b>7</b>	158	195	<b>SB1000 2-7/16</b>	2,95
<b>74,61</b>	130	31	92,075	1,5	22,2	<b>7</b>	190	250	<b>SB1000 2-15/16</b>	3,22
<b>87,31</b>	160	40	102,4	2	22,23	<b>7</b>	305	410	<b>SB1000 3-7/16</b>	5,74
<b>100,035</b>	180	46	116	2,1	25,4	<b>7</b>	536	905	<b>SB1000 3-15/16</b>	8,31
<b>112,71</b>	200	53	155,58	2,1	25,4	<b>8</b>	590	770	<b>SB1000 4-7/16 VSB</b>	11,8
<b>125,41</b>	230	64	168,28	3	25,4	<b>8</b>	660	1700	<b>SB1000 4-15/16 VSB</b>	18
<b>100</b>	165	65	52	2		<b>5</b>	309	459	<b>26120 MB</b>	5,08
<b>100</b>	180	82	69	2,1		<b>4</b>	436	627	<b>26220 CP</b>	9,36
<b>110</b>	180	82	69	2		<b>6</b>	449	741	<b>26122 CAW33</b>	7,53



# Thrust Ball Bearings

## Standards, Boundary dimensions

Standard plans	DIN 616
Thrust ball bearings single direction	DIN 711
Thrust ball bearings double direction	DIN 715
Seating washers	DIN 711

## General

Thrust Ball Bearings are separable axial bearings that are produced in both single and double direction acting design. To assist in simple effective mounting or dismounting the bearing washers, seating's, and cage and ball assemblies, may be individually mounted in their arrangement location.

Thrust ball bearings may accommodate comparatively high axial loads but they must not be exposed to any radial forces.

Due to their specific kinematic behavior, thrust ball bearings are only suitable for low to medium operating speeds.

Furthermore, they require minimum axial loads for their optimum function. Since thrust ball bearings do not compensate any misalignment, they are also frequently used in conjunction with sphered housing washers and seating washers.

**Design variants** (see drawing on next page)

**Thrust ball bearings** are produced in both, single direction and double direction design. The most important design variants are shown on the next page.

**Single direction thrust ball bearings** consist of a **shaft washer**, a **housing washer** and a **ball and cage thrust assembly** (see figure a, b and c).

These bearings are able to accommodate axial loads in one direction only.

**Single direction thrust ball bearings** of series **511, 512, 513** and **514** have plain housing washers, (see figure a).

For applications where some misalignment may occur, single direction thrust ball bearings of the series **532, 533** and **534** are also available with sphered housing washers, figure b.

These bearings may be applied either direct to sphered shaped bearings seats or, they may be used together with **seating washers** of series **U2, U3** or **U4** (see figure c).

Unlike single direction thrust ball bearing types, **double direction thrust ball bearings** are suitable to guide the shaft in both directions (see figure d, e and f).

These bearings consist of two washers, **two balls and cage thrust assemblies** with one common **shaft washer** located centrally in between.

Double direction thrust ball bearings are also available in both designs, with **at housing washers** (series **522, 523** and **524** figure d) and with sphered housing washers (series **542, 543** and **544** figure e).

For compensation of possible aligning errors the double direction thrust ball bearings may be used in conjunction with **Seating Washers** (series **U2, U3** and **U4**, see figure f).

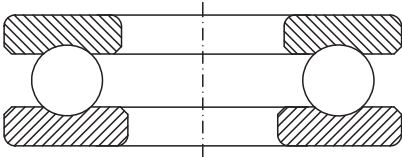

a

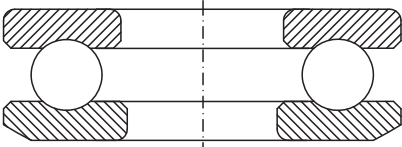

b

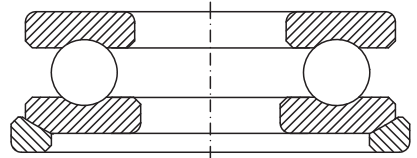

c

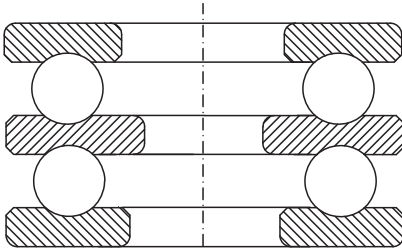

d

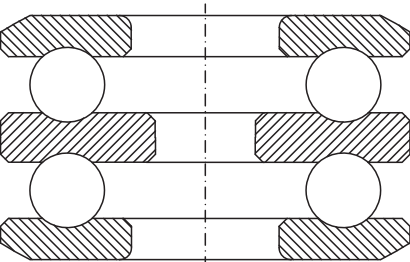

e

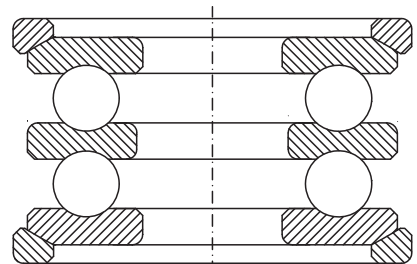

f

## Misalignment

**All thrust ball bearings with flat housing washers do not allow any misalignment.**

The contacting surfaces of both shaft and housing seats must be parallel. Misalignments can only be accommodated by using Thrust Ball bearings with **sphered housing washers**.

## Cages

**URB** thrust ball bearings are normally fitted with pressed steel cages as standard.

For larger thrust ball bearings solid brass cages (suffix **M**), or solid steel cages (suffix **F**), are fitted as standard.

## Tolerances

**URB** thrust ball bearings are produced to normal class tolerance class (**PN**) as standard.

For applications of higher dimensional and geometrical accuracy these bearings are produced to precision tolerance class (e.g. **P6**) on order request.

For detailed values of the tolerance classes see chapter **Bearing tolerances** (see page 39-40).

## Minimum load:

Thrust ball bearings require a certain minimum axial load to ensure a satisfactory operating function.

To prevent excessive sliding friction, the minimum axial load applied should be greater than **4%** of the axial bearing dynamic load rating **Ca**.

Where such a minimum axial load is not possible, the load must be increased by effective measures, (i.e. preloading the bearing) using pressure washers or springs.

## Equivalent dynamic bearing load

Thrust ball bearings are pure axial bearings, there are not able to accommodate any radial loads, therefore:

$$P = F_a$$

## Equivalent static bearing load

For thrust ball bearings:

$$P_0 = F_a$$

## Abutment and Fillet dimensions for thrust ball bearings

The bearing washer must contact adjacent parts with their face sides only. The radii of bearing shoulder fillet radii of the shaft or housing shoulders.

Therefore fillet radius ( $r_f$ ) must be smaller than the minimum fillet dimension of the bearing rings ( $r_g$ ) as listed in the bearing tables.



**Abutment and Fillet dimensions for Thrust Ball bearings of series 511, 512, 513 and 514 [mm]**

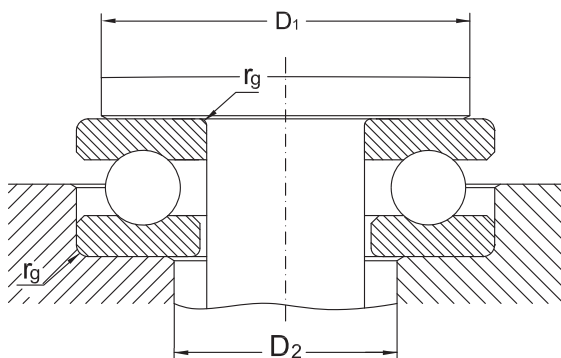

Shaft	Bore reference number	Bearing Series											
		511			512			513			514		
$\varnothing d_1$		$D_1$ min	$D_2$ min	$r_g$ max	$D_1$ min	$D_2$ min	$r_g$ max	$D_1$ min	$D_2$ min	$r_g$ max	$D_1$ min	$D_2$ min	$r_g$ max
mm													
10	0	18	16	0,3	20	16	0,6	-	-	-	-	-	-
12	1	20	18	0,3	22	18	0,6	-	-	-	-	-	-
15	2	23	20	0,3	25	22	0,6	-	-	-	-	-	-
17	3	25	22	0,3	28	24	0,6	-	-	-	-	-	-
20	4	29	26	0,3	32	28	0,6	-	-	-	-	-	-
25	5	35	32	0,6	38	34	0,6	41	36	1	46	39	1
30	6	40	37	0,6	43	39	0,6	48	42	1	54	46	1
35	7	45	42	0,6	51	46	1	55	48	1	62	53	1
40	8	52	48	0,6	57	51	1	63	55	1	70	60	1
45	9	57	53	0,6	62	56	1	69	61	1	78	67	1
50	10	62	58	0,6	67	61	1	77	68	1	86	74	1,5
55	11	69	64	0,6	76	69	1	85	75	1	94	81	1,5
60	12	75	70	1	81	74	1	90	80	1	102	88	1,5
65	13	80	75	1	86	79	1	95	85	1	110	95	2
70	14	85	80	1	91	84	1	103	92	1	118	102	2
75	15	90	85	1	96	89	1	111	99	1,5	126	109	2
80	16	95	90	1	101	94	1	116	104	1,5	134	116	2,1
85	17	100	95	1	109	101	1	124	111	1,5	142	123	2,1
90	18	108	102	1	117	108	1	129	116	1,5	150	130	2,1
100	20	121	114	1	130	120	1	142	128	1,5	166	144	2,5
110	22	131	124	1	140	130	1	158	142	2	182	158	2,5
120	24	141	134	1	150	140	1	174	156	2,1	198	172	3
130	26	154	146	1	166	154	1	187	168	2,1	214	186	3
140	28	164	156	1	176	164	1	200	180	2,1	224	196	3
150	30	174	166	1	189	176	1	210	190	2,1	240	210	3



## Abutment and Fillet dimensions for Thrust Ball bearings of series 511, 512 and 513 [mm]

Shaft	Bore reference number	Bearing Series								
		511			512			513		
$\varnothing d_1$		$D_1$ min	$D_2$ min	$r_g$ max	$D_1$ min	$D_2$ min	$r_g$ max	$D_1$ min	$D_2$ min	$r_g$ max
mm										
<b>160</b>	<b>32</b>	184	176	1	199	186	1,5	226	204	2,5
<b>170</b>	<b>34</b>	197	188	1	212	198	1,5	236	214	2,5
<b>180</b>	<b>36</b>	207	198	1	222	208	1,5	252	228	2,5
<b>190</b>	<b>38</b>	220	210	1	238	222	2	268	242	3
<b>200</b>	<b>40</b>	230	220	1	248	232	2	284	256	3
<b>220</b>	<b>44</b>	250	240	1	268	252	2	-	-	-
<b>240</b>	<b>48</b>	276	264	1,5	300	280	2,1	-	-	-
<b>260</b>	<b>52</b>	296	284	1,5	320	300	2,1	-	-	-
<b>280</b>	<b>56</b>	322	308	1,5	340	320	2,1	-	-	-
<b>300</b>	<b>60</b>	348	332	2	372	348	2,5	-	-	-
<b>320</b>	<b>64</b>	368	352	2	392	368	2,5	-	-	-
<b>340</b>	<b>68</b>	388	372	2	412	388	2,5	-	-	-
<b>360</b>	<b>72</b>	408	392	2	444	416	3	-	-	-
<b>380</b>	<b>76</b>	428	412	2	-	-	-	-	-	-
<b>400</b>	<b>80</b>	448	432	2	-	-	-	-	-	-
<b>420</b>	<b>84</b>	468	452	2	-	-	-	-	-	-
<b>440</b>	<b>88</b>	500	480	2,1	-	-	-	-	-	-
<b>460</b>	<b>92</b>	520	500	2,1	-	-	-	-	-	-
<b>480</b>	<b>96</b>	540	520	2,1	-	-	-	-	-	-
<b>500</b>	<b>/500</b>	560	540	2,1	-	-	-	-	-	-
<b>530</b>	<b>/530</b>	596	574	2,5	-	-	-	-	-	-
<b>560</b>	<b>/560</b>	626	604	2,5	-	-	-	-	-	-



**Abutment and Fillet dimensions for Thrust Ball bearings of series 532, 533, and 534 [mm]**

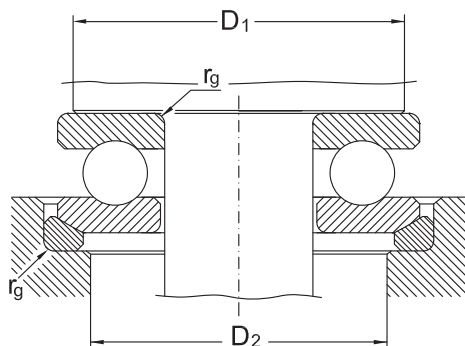
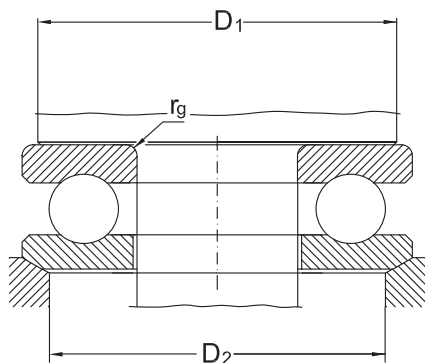

Shaft $\varnothing d_1$	Bore reference number	Bearing Series								
		532			533			534		
		$D_1$ min	$D_2$ min	$r_g$ max	$D_1$ min	$D_2$ min	$r_g$ max	$D_1$ min	$D_2$ min	$r_g$ max
mm										
10	0	20	18	0,6	-	-	-	-	-	-
12	1	22	20	0,6	-	-	-	-	-	-
15	2	25	24	0,6	-	-	-	-	-	-
17	3	28	26	0,6	-	-	-	-	-	-
20	4	32	30	0,6	-	-	-	-	-	-
25	5	38	36	0,6	41	38	1	46	42	1
30	6	43	42	0,6	48	45	1	54	50	1
35	7	51	48	1	55	52	1	62	58	1
40	8	57	55	1	63	60	1	70	65	1
45	9	62	60	1	69	65	1	78	72	1
50	10	67	62	1	77	72	1	86	80	1,5
55	11	76	72	1	85	80	1	94	88	1,5
60	12	81	78	1	90	85	1	102	95	1,5
65	13	86	82	1	95	90	1	110	100	2
70	14	91	88	1	103	98	1	118	110	2
75	15	96	92	1	111	105	1,5	126	115	2
80	16	101	98	1	116	110	1,5	134	125	2,1
85	17	109	105	1	124	115	1,5	142	130	2,1
90	18	117	110	1	129	120	1,5	150	140	2,1
100	20	130	125	1	142	135	1,5	166	155	2,5
110	22	140	135	1	158	150	2	182	170	2,5
120	24	150	145	1	174	165	2	195	185	3
130	26	166	160	1,5	187	177	2,1	214	200	3
140	28	176	170	1,5	200	190	2,1	-	-	-
150	30	189	180	1,5	210	200	2,1	-	-	-
160	32	199	190	1,5	-	-	-	-	-	-
170	34	212	200	1,5	-	-	-	-	-	-
180	36	222	210	1,5	-	-	-	-	-	-
190	38	238	230	1,5	-	-	-	-	-	-

### Abutment and Fillet dimensions for Thrust Ball bearings of series 522, 523 and 524 [mm]

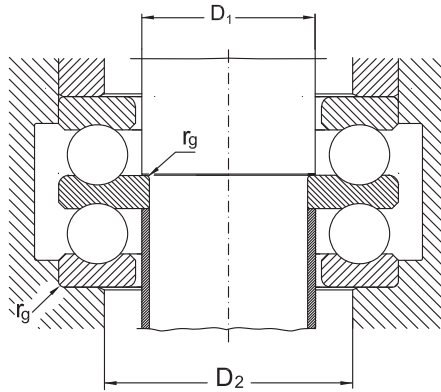

Shaft $\varnothing d_1$	Bore reference number	Bearing Series													
		522				523				524					
		$D_1$ min	$D_2$ min	$r_g$ max	$r_{g1}$ max	$D_1$ min	$D_2$ min	$r_g$ max	$r_{g1}$ max	Shaft	$D_1$ min	$D_2$ min	$r_g$ max	$r_{g1}$ max	
mm															
<b>10</b>	<b>2</b>	15	22	0,6	0,3	-	-	-	-	-	-	-	-	-	
<b>15</b>	<b>4</b>	20	28	0,6	0,3	-	-	-	-	-	-	-	-	-	
<b>20</b>	<b>5</b>	25	34	0,6	0,3	25	36	1	0,3	<b>15</b>	25	39	1	0,6	
<b>25</b>	<b>6</b>	30	39	0,6	0,3	30	42	1	0,3	<b>20</b>	30	46	1	0,6	
<b>30</b>	<b>7</b>	35	46	1	0,3	35	48	1	0,3	<b>25</b>	35	53	1	0,6	
<b>30</b>	<b>8</b>	40	51	1	0,6	40	55	1	0,6	<b>30</b>	40	60	1	0,6	
<b>35</b>	<b>9</b>	45	56	1	0,6	45	61	1	0,6	<b>35</b>	45	67	1	0,6	
<b>40</b>	<b>10</b>	50	61	1	0,6	50	68	1	0,6	<b>40</b>	50	74	1,5	0,6	
<b>45</b>	<b>11</b>	55	69	1	0,6	55	75	1	0,6	<b>45</b>	55	81	1,5	0,6	
<b>50</b>	<b>12</b>	60	74	1	0,6	60	80	1	0,6	<b>50</b>	60	88	1,5	0,6	
<b>55</b>	<b>13</b>	65	79	1	0,6	65	85	1	0,6	<b>50</b>	65	95	2	1	
<b>55</b>	<b>14</b>	70	84	1	1	70	92	1	1	<b>55</b>	70	102	2	1	
<b>60</b>	<b>15</b>	75	89	1	1	75	99	1,5	1	<b>60</b>	75	109	2	1	
<b>65</b>	<b>16</b>	80	94	1	1	80	104	1,5	1	<b>65</b>	80	116	2,1	1	
<b>70</b>	<b>17</b>	85	101	1	1	85	111	1,5	1	<b>65</b>	85	123	2,1	1	
<b>75</b>	<b>18</b>	90	108	1	1	90	116	1,5	1	<b>70</b>	90	130	2,1	1	
<b>85</b>	<b>20</b>	100	120	1	1	100	128	1,5	1	<b>80</b>	100	144	2,5	1	
<b>95</b>	<b>22</b>	110	130	1	1	110	142	2	1	-	-	-	-	-	
<b>100</b>	<b>24</b>	120	140	1	1	120	156	2,1	1	-	-	-	-	-	
<b>110</b>	<b>26</b>	130	154	1,5	1	130	168	2,1	1	-	-	-	-	-	
<b>120</b>	<b>28</b>	140	164	1,5	1	140	180	2,1	1	-	-	-	-	-	
<b>130</b>	<b>30</b>	150	176	1,5	1	150	190	2,1	1	-	-	-	-	-	
<b>140</b>	<b>32</b>	160	186	1,5	1	-	-	-	-	-	-	-	-	-	
<b>150</b>	<b>34</b>	170	198	1,5	1	-	-	-	-	-	-	-	-	-	



### Abutment and Fillet dimensions for Thrust Ball bearings of series 542, 543 and 544 [mm]

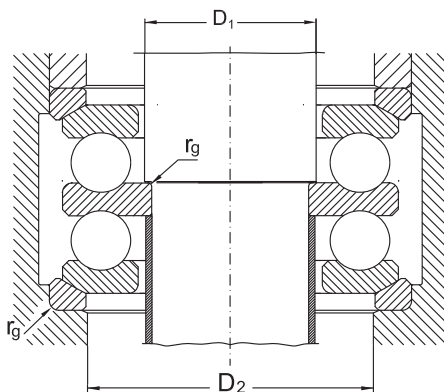

Shaft Ød1	Bore reference number	Bearing Series												
		542				543				544				
		D <sub>1</sub> min	D <sub>2</sub> min	r <sub>g</sub> max	r <sub>g1</sub> max	D <sub>1</sub> min	D <sub>2</sub> min	r <sub>g</sub> max	r <sub>g1</sub> max	Shaft	D <sub>1</sub> min	D <sub>2</sub> min	r <sub>g</sub> max	r <sub>g1</sub> max
		mm												
<b>10</b>	<b>2</b>	15	24	0,6	0,3	-	-	-	-	-	-	-	-	-
<b>15</b>	<b>4</b>	20	30	0,6	0,3	-	-	-	-	-	-	-	-	-
<b>20</b>	<b>5</b>	25	36	0,6	0,3	25	38	1	0,3	<b>15</b>	25	42	1	0,6
<b>25</b>	<b>6</b>	30	42	0,6	0,3	30	45	1	0,3	<b>20</b>	30	50	1	0,6
<b>30</b>	<b>7</b>	35	48	1	0,3	35	52	1	0,3	<b>25</b>	35	58	1	0,6
<b>30</b>	<b>8</b>	40	55	1	0,6	40	60	1	0,6	<b>30</b>	40	65	1	0,6
<b>35</b>	<b>9</b>	45	60	1	0,6	45	65	1	0,6	<b>35</b>	45	72	1	0,6
<b>40</b>	<b>10</b>	50	62	1	0,6	50	72	1	0,6	<b>40</b>	50	80	1,5	0,6
<b>45</b>	<b>11</b>	55	72	1	0,6	55	80	1	0,6	<b>45</b>	55	88	1,5	0,6
<b>50</b>	<b>12</b>	60	78	1	0,6	60	85	1	0,6	<b>50</b>	60	95	1,5	0,6
<b>55</b>	<b>13</b>	65	82	1	0,6	65	90	1	0,6	<b>50</b>	65	100	2	1
<b>55</b>	<b>14</b>	70	88	1	1	70	98	1	1	<b>55</b>	70	110	2	1
<b>60</b>	<b>15</b>	75	92	1	1	75	105	1,5	1	<b>60</b>	75	115	2	1
<b>65</b>	<b>16</b>	80	98	1	1	80	110	1,5	1	<b>65</b>	80	125	2,1	1
<b>70</b>	<b>17</b>	85	105	1	1	85	115	1,5	1	<b>65</b>	85	130	2,1	1
<b>75</b>	<b>18</b>	90	110	1	1	90	120	1,5	1	<b>70</b>	90	140	2,1	1
<b>85</b>	<b>20</b>	100	125	1	1	100	135	1,5	1	<b>80</b>	100	155	2,5	1
<b>95</b>	<b>22</b>	110	135	1	1	110	150	2	1	-	-	-	-	-
<b>100</b>	<b>24</b>	120	145	1	1	120	165	2,1	1	-	-	-	-	-
<b>110</b>	<b>26</b>	130	160	1,5	1	-	-	-	-	-	-	-	-	-

# URB





### Thrust Ball bearings, single direction

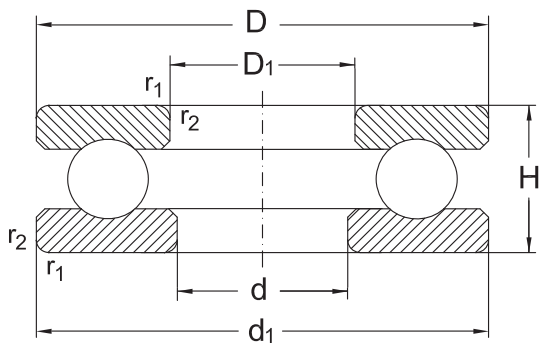

511/ 512/ 513/514

Shaft	Dimension			Designation	Basical axial load		Speed limit		
	d	D	H		r <sub>1</sub> , r <sub>2</sub> min.	dyn. C <sub>a</sub>	stat. C <sub>0a</sub>	grease	oil
	mm					kN		min <sup>-1</sup>	
10	24	9	0,3	51100	10	14	7000	9500	
	26	11	0,6	51200	12,7	17,1	6000	8000	
12	26	9	0,3	51101	10,4	15,4	6700	9000	
	28	11	0,6	51201	13,2	19	6000	8000	
15	28	9	0,3	51102	10,5	16,8	6300	8500	
	32	11	0,6	51202	16,6	25	5000	6700	
17	30	9	0,3	51103	10,8	18,2	6300	8500	
	35	12	0,6	51203	17,3	27,5	5000	6700	
20	35	10	0,3	51104	14,9	26,6	5300	7000	
	40	14	0,6	51204	22,4	37,7	4300	5600	
25	42	11	0,6	51105	15,6	30,4	4800	6300	
	47	15	0,6	51205	28	50,5	3800	5000	
	52	18	1	51305	35,4	61,5	3150	4200	
	60	24	1	51405	56	90	2600	3600	
30	47	11	0,6	51106	18,6	39,9	4300	5600	
	52	16	0,6	51206	28,1	54,3	3600	4800	
	60	21	1	51306	42,2	78,7	2900	3900	
	70	28	1	51406	72	125	2200	3200	
35	52	12	0,6	51107	19,1	44,4	4000	5300	

## Thrust Ball bearings, single direction

Shaft	Dimensions		Mass
	d <sub>1</sub>	D <sub>1</sub>	
d			Bearing
	mm		[kg]
10	24	11	0,02
	26	12	0,03
12	26	13	0,02
	28	14	0,03
15	28	16	0,02
	32	17	0,05
17	30	18	0,03
	35	19	0,05
20	35	21	0,04
	40	22	0,08
25	42	26	0,06
	47	27	0,12
	52	27	0,17
	60	27	0,36
30	47	32	0,07
	52	32	0,13
	60	32	0,26
	70	32	0,58
35	52	37	0,09



**Thrust Ball bearings, single direction**

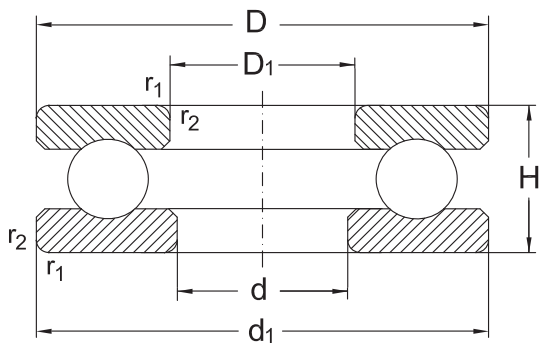

511/ 512/ 513/514

Shaft	Dimension			Designation	Basical axial load		Speed limit		
	d	D	H		$r_1, r_2$ min.	dyn. $C_a$	stat. $C_{0a}$	grease	oil
	mm					kN		min <sup>-1</sup>	
35	62	18	1	<b>51207</b>	38,8	78,2	3000	4000	
	68	24	1	<b>51307</b>	55,4	105	2600	3600	
	80	32	1,1	<b>51407</b>	86,5	156	2000	3000	
40	60	13	0,6	<b>51108</b>	26,8	62,9	3400	4500	
	68	19	1	<b>51208</b>	46,9	98,3	2800	3800	
	78	26	1	<b>51308</b>	68,4	135	2200	3200	
	90	36	1,1	<b>51408</b>	112	204	1700	2400	
45	65	14	0,6	<b>51109</b>	27,2	69,2	3400	4500	
	73	20	1	<b>51209</b>	49,3	112	2600	3600	
	85	28	1	<b>51309</b>	78,9	164	2000	3000	
	100	39	1,1	<b>51409</b>	140	262	1600	2200	
50	70	14	0,6	<b>51110</b>	28,1	75,5	3200	4300	
	78	22	1	<b>51210</b>	56,3	129	2400	3400	
	95	31	1,1	<b>51310</b>	95,3	202	1900	2800	
	110	43	1,5	<b>51410</b>	156	310	1500	2000	
55	78	16	0,6	<b>51111</b>	31,1	81,5	2800	3800	
	90	25	1	<b>51211</b>	68,8	159	2200	3200	
	105	35	1,1	<b>51311</b>	118	246	1700	2400	
	120	48	1,5	<b>51411</b>	180	360	1300	1800	



## Thrust Ball bearings, single direction

Shaft	Dimensions		Mass
	d <sub>1</sub>	D <sub>1</sub>	
d			Bearing
	mm		[kg]
35	62	37	0,22
	68	37	0,38
	80	37	0,96
40	60	42	0,13
	68	42	0,28
	78	42	0,53
	90	42	1,17
45	65	47	0,15
	73	47	0,30
	85	47	0,61
	100	47	1,60
50	70	52	0,17
	78	52	0,37
	95	52	0,94
	110	52	2,18
55	78	57	0,25
	90	57	0,59
	105	57	1,30
	120	57	2,91



**Thrust Ball bearings, single direction**

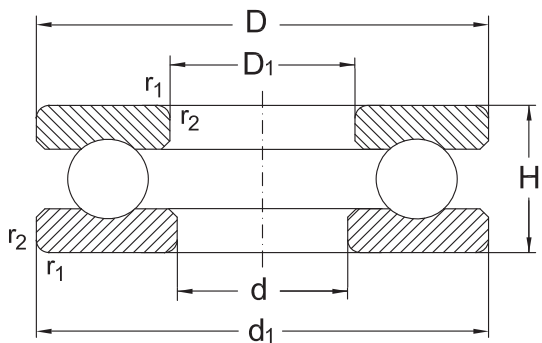

511/ 512/ 513/514

Shaft	Dimension			Designation	Basical axial load		Speed limit		
	d	D	H		$r_1, r_2$ min.	dyn. $C_a$	stat. $C_{0a}$	grease	oil
	mm					kN		min <sup>-1</sup>	
<b>60</b>	85	17	1	<b>51112</b>	37,9	98,6	2600	3600	
	95	26	1	<b>51212</b>	70,4	169	2000	3000	
	110	35	1,1	<b>51312</b>	123	267	1600	2200	
	130	51	1,5	<b>51412 M</b>	200	400	1200	1700	
<b>65</b>	90	18	1	<b>51113</b>	39,2	108	2400	3400	
	100	27	1	<b>51213</b>	78,5	191	2000	3000	
	115	36	1,1	<b>51313</b>	127	287	1600	2200	
	140	56	2	<b>51413 M</b>	216	450	1100	1600	
<b>70</b>	95	18	1	<b>51114</b>	39,3	113	2400	3400	
	105	27	1	<b>51214</b>	72,8	189	1900	2800	
	125	40	1,1	<b>51314</b>	153	341	1400	1900	
	150	60	2	<b>51414 M</b>	236	500	1100	1600	
<b>75</b>	100	19	1	<b>51115</b>	47,2	140	2200	3200	
	110	27	1	<b>51215</b>	73,7	199	1900	2800	
	135	44	1,5	<b>51315</b>	184	426	1300	1800	
	160	65	2	<b>51415 M</b>	250	560	1000	1500	
<b>80</b>	105	19	1	<b>51116</b>	48,5	145	2200	3200	
	115	28	1	<b>51216</b>	76,1	209	1800	2600	
	140	44	1,5	<b>51316</b>	181	426	1300	1800	
	170	68	2,1	<b>51416 M</b>	270	620	950	1400	

## Thrust Ball bearings, single direction

Shaft	Dimensions		Mass
	d	d <sub>1</sub>	
	mm		Bearing
			[kg]
<b>60</b>	85	62	0,33
	95	62	0,65
	110	62	1,37
	130	62	3,70
<b>65</b>	90	67	0,36
	100	67	0,74
	115	67	1,49
	140	68	4,67
<b>70</b>	95	72	0,39
	105	72	0,78
	125	72	1,91
	150	73	5,72
<b>75</b>	100	77	0,52
	110	77	0,83
	135	77	2,61
	160	78	7,06
<b>80</b>	105	82	0,56
	115	82	0,91
	140	82	2,71
	170	83	8,23



**Thrust Ball bearings, single direction**

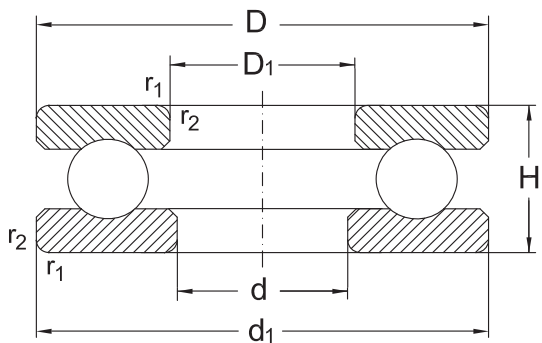

511/ 512/ 513/514

Shaft	Dimension			Designation	Basical axial load		Speed limit		
	d	D	H		$r_1, r_2$ min.	dyn. $C_a$	stat. $C_{0a}$	grease	oil
	mm					kN		min <sup>-1</sup>	
<b>85</b>	110	19	1	<b>51117</b>	48	151	2200	3200	
	125	31	1	<b>51217</b>	98	264	1600	2200	
	150	49	1,5	<b>51317</b>	290	716	1200	1700	
	180	72	2,1	<b>51417 M</b>	290	680	900	1300	
<b>90</b>	120	22	1	<b>51118</b>	62,3	190	1900	2800	
	135	35	1,1	<b>51218</b>	127	338	1500	2000	
	155	50	1,5	<b>51318</b>	196	465	1200	1700	
	190	77	2,1	<b>51418 M</b>	305	750	850	1200	
<b>100</b>	135	25	1	<b>51120</b>	85	270	1600	2200	
	150	38	1,1	<b>51220</b>	149	402	1400	1900	
	170	55	1,5	<b>51320</b>	247	628	1100	1600	
	210	85	3	<b>51420 M</b>	365	965	750	1000	
<b>110</b>	145	25	1	<b>51122</b>	86,5	290	1600	2200	
	160	38	1,1	<b>51222</b>	156	447	1300	1800	
	190	63	2	<b>51322</b>	319	869	950	1400	
	230	95	3	<b>51422 M</b>	415	1140	700	950	
<b>120</b>	155	25	1	<b>51124</b>	90	310	1500	2000	
	170	39	1,1	<b>51224</b>	170	509	1200	1700	
	210	70	2,1	<b>51324</b>	325	915	850	1200	
	250	102	4	<b>51424 M</b>	425	1220	670	900	

## Thrust Ball bearings, single direction

Shaft	Dimensions		Mass
	d	D <sub>1</sub>	
	mm		[kg]
<b>85</b>	110	87	0,60
	125	88	1,22
	150	88	3,53
	177	88	9,79
<b>90</b>	120	92	0,88
	135	93	1,68
	155	93	3,57
	187	93	11,60
<b>100</b>	135	102	1,30
	150	103	2,22
	170	103	4,95
	205	103	15,40
<b>110</b>	145	112	1,45
	160	113	2,41
	187	113	7,70
	225	113	20,80
<b>120</b>	155	122	1,59
	170	123	2,67
	205	123	10,70
	245	123	26,50



**Thrust Ball bearings, single direction**

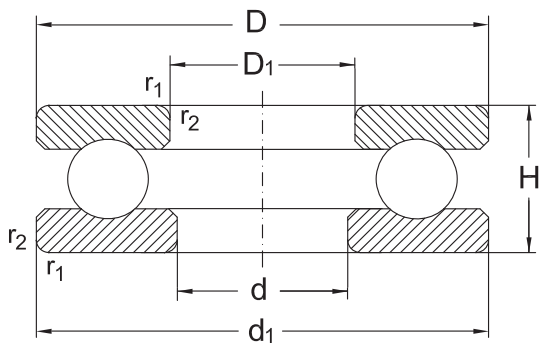

511/ 512/ 513/514

Shaft	Dimension			Designation	Basical axial load		Speed limit		
	d	D	H		r <sub>1</sub> , r <sub>2</sub> min.	dyn. C <sub>a</sub>	stat. C <sub>0a</sub>	grease	oil
	mm					kN		min <sup>-1</sup>	
<b>130</b>	170	30	1	<b>51126</b>	117	392	1300	1800	
	190	45	1,5	<b>51226</b>	183	540	1100	1600	
	225	75	2,1	<b>51326 M</b>	360	1060	800	1100	
	270	110	4	<b>51426 M</b>	520	1600	600	800	
<b>140</b>	180	31	1	<b>51128</b>	112	400	1300	1800	
	200	46	1,5	<b>51228</b>	190	570	1000	1500	
	240	80	2,1	<b>51328 M</b>	400	1220	750	1000	
<b>150</b>	190	31	1	<b>51130 M</b>	110	400	1200	1700	
	215	50	1,5	<b>51230 M</b>	236	735	950	1400	
	250	80	2,1	<b>51330 M</b>	405	1290	700	950	
	300	120	4	<b>51430 M</b>	560	1800	560	750	
<b>160</b>	200	31	1	<b>51132 M</b>	112	430	1200	1700	
	225	51	1,5	<b>51232 M</b>	245	780	950	1400	
	270	87	3	<b>51332M</b>	479	1582	670	900	
<b>170</b>	215	34	1,1	<b>51134 M</b>	132	500	1100	1600	
	240	55	1,5	<b>51234 M</b>	285	930	850	1200	
	280	87	3	<b>51334 M</b>	496	1704	670	900	
<b>180</b>	225	34	1,1	<b>51136 M</b>	134	530	1000	1500	
	250	56	1,5	<b>51236 M</b>	290	1000	850	1200	
	300	95	3	<b>51336 M</b>	546	1956	600	800	

## Thrust Ball bearings, single direction

Shaft	Dimensions		Mass
	d <sub>1</sub>	D <sub>1</sub>	
d			Bearing
	mm		[kg]
130	170	132	2,37
	187	133	3,99
	220	134	13,00
	265	134	32,80
140	178	142	2,59
	197	143	4,33
	235	144	15,70
150	188	152	2,26
	212	153	6,09
	245	154	16,40
	295	154	43,10
160	198	162	2,39
	222	163	6,56
	265	164	21,30
170	213	172	3,08
	237	173	8,12
	275	174	22,50
180	222	183	3,17
	245	183	8,70
	295	184	28,3



### Thrust Ball bearings, single direction

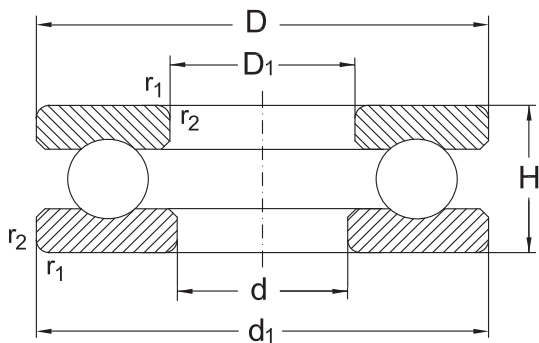

511/ 512/ 513/514

Shaft	Dimension			Designation	Basical axial load		Speed limit		
	d	D	H		$r_1, r_2$ min.	dyn. $C_a$	stat. $C_{0a}$	grease	oil
	mm					kN		min <sup>-1</sup>	
190	240	37	1,1	51138 M	170	655	950	1400	
	270	62	2	51238 M	335	1160	750	1000	
	320	105	4	51338 M	600	2200	560	750	
200	250	37	1,1	51140 M	170	655	950	1400	
	280	62	2	51240 M	340	1220	750	1000	
	340	110	4	51340 M	656	2414	530	700	
220	270	37	1,1	51144 M	176	735	850	1200	
	300	63	2	51244 M	355	1340	700	950	
240	300	45	1,5	51148 M	232	965	750	1000	
	340	78	2,1	51248 M	465	1860	600	800	
260	320	45	1,5	51152 M	236	1020	750	1000	
	360	79	2,1	51252 M	475	2000	560	750	
280	350	53	1,5	51156 M	315	1340	670	900	
	380	80	2,1	51256 M	490	2160	560	750	
300	380	62	2	51160 M	365	1600	600	800	
	420	95	3	51260 M	610	2750	480	630	
320	400	63	2	51164 M	375	1700	560	750	
	440	95	3	51264 M	620	2900	480	630	
340	420	64	2	51168 M	380	1800	560	750	
	460	96	3	51268 M	640	3150	450	600	



## Thrust Ball bearings, single direction

Shaft	Dimensions		Mass
	d <sub>1</sub>	D <sub>1</sub>	
d			Bearing
	mm		[kg]
<b>190</b>	237	193	4,08
	265	194	11,70
	315	195	35,70
<b>200</b>	245	203	4,26
	275	204	12,00
	335	205	44,30
<b>220</b>	265	223	4,64
	295	224	13,20
<b>240</b>	297	243	7,69
	335	244	23,00
<b>260</b>	317	263	8,25
	355	264	25,20
<b>280</b>	347	283	12,50
	375	284	26,70
<b>300</b>	376	304	17,70
	415	304	42,30
<b>320</b>	396	324	19,10
	435	325	44,20
<b>340</b>	416	344	20,50
	455	345	47,00



**Thrust Ball bearings, single direction**

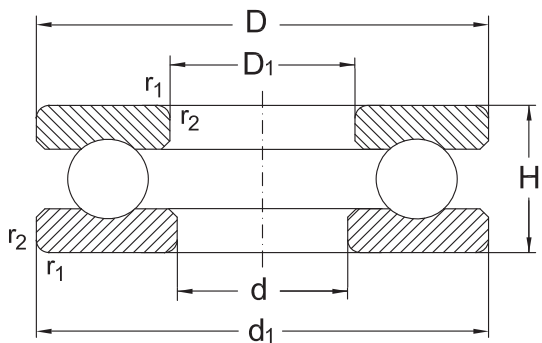

511/ 512/ 513/514

Shaft	Dimension			Designation	Basical axial load		Speed limit		
	d	D	H		$r_1, r_2$ min.	dyn. $C_a$	stat. $C_{0a}$	grease	oil
	mm					kN		min <sup>-1</sup>	
<b>360</b>	440	65	2	<b>51172 M</b>	405	2000	530	700	
	500	110	4	<b>51272 M</b>	765	3900	400	530	
<b>380</b>	460	65	2	<b>51176 M</b>	430	2240	500	670	
<b>400</b>	480	65	2	<b>51180 M</b>	440	2320	500	670	
<b>420</b>	500	65	2	<b>51184 M</b>	440	2450	480	630	
<b>460</b>	560	80	2,1	<b>51192 M</b>	530	3100	430	560	
<b>500</b>	600	80	2,1	<b>511/500 M</b>	550	3350	400	530	
<b>530</b>	640	85	3	<b>511/530 M</b>	620	3900	360	480	
<b>560</b>	670	85	3	<b>511/560 M</b>	630	4150	300	380	

## Thrust Ball bearings, single direction

Shaft	Dimensions		Mass
	$d_1$	$D_1$	
$d$			Bearing
	mm		[kg]
<b>360</b>	436	364	21,50
	495	365	69,50
<b>380</b>	456	384	22,40
<b>400</b>	476	404	23,50
<b>420</b>	495	424	24,40
<b>460</b>	555	464	42,00
<b>500</b>	595	505	44,90
<b>530</b>	635	535	54,80
<b>560</b>	665	565	58,00



**Thrust Ball bearings, double direction**

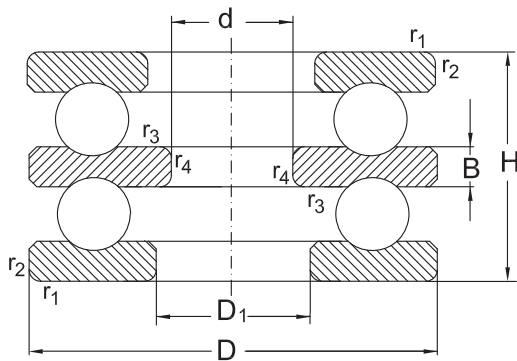

522/ 523/ 524

Shaft	Dimension				Designation	Basical axial load		Speed limit		
	d	D	H	$r_1, r_2$ min.		$r_3, r_4$ min.	dyn. $C_a$	stat. $C_{0a}$	grease	oil
	mm					kN		min <sup>-1</sup>		
<b>10</b>	32	22	22	0,6	0,3	<b>52202</b>	16,6	25	5000	6700
<b>15</b>	40	26	26	0,6	0,3	<b>52204</b>	22,4	37,7	4300	5600
	60	45	45	1	0,6	<b>52205</b>	56	90	2600	3600
<b>20</b>	47	28	28	0,6	0,3	<b>52205</b>	28	50,4	3800	5000
	52	34	34	1	0,3	<b>52305</b>	35,7	61,4	3200	4300
	70	52	52	1	0,6	<b>52406</b>	72	125	2200	3200
<b>25</b>	52	29	29	0,6	0,3	<b>52206</b>	28,1	54,3	3600	4800
	60	38	38	1	0,3	<b>52306</b>	42,8	78,7	3000	4000
	80	59	59	1,1	0,6	<b>52407</b>	86,5	156	2000	3000
<b>30</b>	62	34	34	1	0,3	<b>52207</b>	40,7	83,8	3000	4000
	68	36	36	1	0,6	<b>52208</b>	46,9	98,3	2800	3800
	68	44	44	1	0,3	<b>52307</b>	55,5	105	2600	3600
	78	49	49	1	0,6	<b>52308</b>	69,3	135	2200	3200
	90	65	65	1,1	0,6	<b>52408</b>	112	204	1700	2400
<b>35</b>	73	37	37	1	0,6	<b>52209</b>	47,7	105	2600	3600
	85	52	52	1	0,6	<b>52309</b>	80,8	163	2000	3000
	100	72	72	1,1	0,6	<b>52409</b>	129	245	1600	2200
<b>40</b>	78	39	39	1	0,6	<b>52210</b>	50	111	2400	3400
	95	58	58	1,1	0,6	<b>52310</b>	91,6	186	1900	2800
	110	78	78	1,5	0,6	<b>52410</b>	156	310	1500	2000

## Thrust Ball bearings, double direction

Shaft	Dimensions		Mass
	d	D1	
	mm		[kg]
<b>10</b>	17	5	0,08
<b>15</b>	22	6	0,15
	27	11	0,59
<b>20</b>	27	7	0,22
	27	8	0,32
	32	12	0,92
<b>25</b>	32	7	0,25
	32	9	0,47
	37	14	1,35
<b>30</b>	37	8	0,41
	42	9	55
	37	10	0,68
	42	12	1,01
	42	15	1,92
<b>35</b>	47	9	0,60
	47	12	1,25
	47	17	2,55
<b>40</b>	52	9	0,71
	52	14	1,77
	52	18	3,43



**Thrust Ball bearings, double direction**

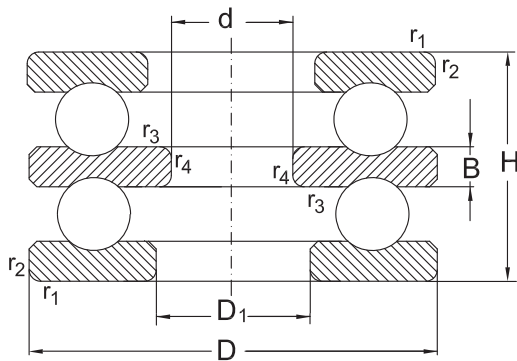

522/ 523/ 524

Shaft	Dimension				Designation	Basical axial load		Speed limit		
	d	D	H	r <sub>1</sub> , r <sub>2</sub> min.		r <sub>3</sub> , r <sub>4</sub> min.	dyn. C <sub>a</sub>	stat. C <sub>0a</sub>	grease	oil
	mm					kN		mn <sup>-1</sup>		
45	90	45	45	1	0,6	<b>52211</b>	69,4	159	2200	3200
	105	64	64	1,1	0,6	<b>52311</b>	119	246	1700	2400
	120	87	87	1,5	0,6	<b>52411</b>	180	360	1300	1800
50	95	46	46	1	0,6	<b>52212</b>	73,6	179	2000	3000
	110	64	64	1,1	0,6	<b>52312</b>	124	267	1600	2200
	130	93	93	1,5	0,6	<b>52412</b>	200	400	1200	1700
	140	101	101	2	1	<b>52413</b>	216	450	1100	1600
55	100	47	47	1	0,6	<b>52213</b>	74,8	189	2000	3000
	105	47	47	1	1	<b>52214</b>	73,6	189	1900	2800
	115	65	65	1,1	0,6	<b>52313</b>	106	220	1600	2200
	125	72	72	1,1	1	<b>52314</b>	148	339	1400	1900
	150	107	107	2	1	<b>52414</b>	236	500	1100	1600
60	110	47	47	1	1	<b>52215</b>	77,4	209	1900	2800
	135	79	79	1,5	1	<b>52315</b>	171	396	1300	1800
	160	115	115	2	1	<b>52415</b>	250	560	1000	1500
65	115	48	48	1	1	<b>52216</b>	78,5	218	1800	2600
	140	79	79	1,5	1	<b>52316</b>	176	424	1300	1800
	170	120	120	2	1	<b>52416</b>	270	620	950	1400
	180	128	128	2,1	1,1	<b>52417</b>	290	680	900	1300
70	125	55	55	1	1	<b>52217</b>	92,3	251	1600	2200

## Thrust Ball bearings, double direction

Shaft	Dimensions		Mass
	d	D <sub>1</sub>	
	mm		Bearing [kg]
45	57	10	1,10
	57	15	2,38
	57	20	4,52
50	62	10	1,21
	62	15	2,53
	62	21	5,72
	68	23	7,18
55	67	10	1,34
	72	10	1,47
	67	15	2,73
	72	16	3,66
	73	24	8,76
60	77	10	1,57
	77	18	4,80
	78	26	10,80
65	82	10	1,72
	82	18	4,94
	83	27	12,70
	88	29	15,10
70	88	12	2,39



**Thrust Ball bearings, double direction**

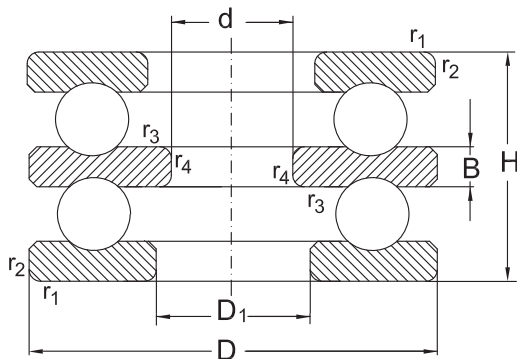

522/ 523/ 524

Shaft	Dimension				Designation	Basical axial load		Speed limit		
	d	D	H	r <sub>1</sub> , r <sub>2</sub> min.		r <sub>3</sub> , r <sub>4</sub> min.	dyn. C <sub>a</sub>	stat. C <sub>0a</sub>	grease	oil
	mm					kN		min <sup>-1</sup>		
<b>70</b>	150	87	1,5	1	<b>52317</b>	190	425	1200	1700	
	190	135	2,1	1,1	<b>52418</b>	305	750	850	1200	
<b>75</b>	135	62	1,1	1	<b>52218</b>	120	326	1500	2000	
	155	88	1,5	1	<b>52318</b>	196	465	1200	1700	
<b>80</b>	210	150	3	1,1	<b>52420</b>	365	965	750	1000	
<b>85</b>	150	67	1,1	1	<b>52220</b>	147	410	1400	1900	
	170	97	1,5	1	<b>52320</b>	236	596	1100	1600	
<b>95</b>	160	67	1,1	1	<b>52222</b>	148	431	1300	1800	
	190	110	2	1	<b>52322 M</b>	275	720	950	1400	
<b>100</b>	170	68	1,1	1,1	<b>52224</b>	154	472	1200	1700	
	210	123	2,1	1,1	<b>52324 M</b>	325	915	850	1200	
<b>110</b>	190	80	1,5	1,1	<b>52226</b>	203	622	1100	1600	
	225	130	2,1	1,1	<b>52326 M</b>	360	1060	800	1100	
<b>120</b>	200	81	1,5	1,1	<b>52228</b>	190	570	1000	1500	
	240	140	2,1	1,1	<b>52328 M</b>	400	1220	750	1000	
<b>130</b>	215	89	1,5	1,1	<b>52230 M</b>	236	735	950	1400	
<b>140</b>	225	90	1,5	1,1	<b>52232 M</b>	245	780	950	1400	
<b>150</b>	240	97	1,5	1,1	<b>52234 M</b>	285	930	850	1200	



## Thrust Ball bearings, double direction

Shaft	Dimensions		Mass
	d	D <sub>1</sub>	
	mm		Bearing [kg]
<b>70</b>	88	19	6,35
	88	30	17,80
<b>75</b>	93	14	3,22
	93	19	6,80
<b>80</b>	103	33	23,80
<b>85</b>	103	15	4,21
	103	21	8,94
<b>95</b>	113	15	4,63
	113	24	13,90
<b>100</b>	123	15	5,23
	123	27	19,40
<b>110</b>	133	18	7,99
	134	30	23,40
<b>120</b>	143	18	8,66
	144	31	28,20
<b>130</b>	153	20	11,40
<b>140</b>	163	20	12,10
<b>150</b>	173	21	14,90



### Thrust Ball bearings, single direction, with Sphered Housing Washer

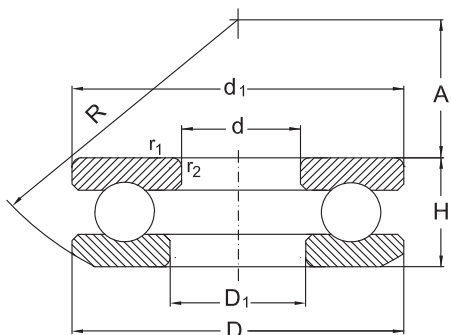

532/ 533/ 534

Dimension				Designation		Basical axial load		Speed limit	
d	D	H	r <sub>1</sub> , r <sub>2</sub> min.	Bearing	Seating Washer	dyn. C <sub>a</sub>	stat. C <sub>0a</sub>	grease	oil
mm						kN		min <sup>-1</sup>	
<b>10</b>	26	11,6	0,6	<b>53200</b>	<b>U200</b>	12,7	17	6000	8000
<b>12</b>	28	11,4	0,6	<b>53201</b>	<b>U201</b>	13,2	19	6000	8000
<b>15</b>	32	13,3	0,6	<b>53202</b>	<b>U202</b>	16,6	25	5000	6700
<b>17</b>	35	13,2	0,6	<b>53203</b>	<b>U203</b>	17,3	27,5	5000	6700
<b>20</b>	40	14,7	0,6	<b>53204</b>	<b>U204</b>	22,4	37,5	4300	5600
<b>25</b>	47	16,7	0,6	<b>53205</b>	<b>U205</b>	28	50	3800	5000
	52	19,8	1	<b>53305</b>	<b>U305</b>	34,5	55	3200	4300
	60	26,4	1	<b>53405</b>	<b>U405</b>	56	90	2600	3600
<b>30</b>	52	17,8	0,6	<b>53206</b>	<b>U206</b>	29,2	58,2	3600	4800
	60	22,6	1	<b>53306</b>	<b>U306</b>	38	65,5	3000	4000
	70	30,1	1	<b>53406</b>	<b>U406</b>	72	125	2200	3200
<b>35</b>	62	19,9	1	<b>53207</b>	<b>U207</b>	35,5	67	3000	4000
	68	25,6	1	<b>53307</b>	<b>U307</b>	50	88	2600	3600
	80	34	1,1	<b>53407</b>	<b>U407</b>	86,5	156	2000	3000
<b>40</b>	68	20,3	1	<b>53208</b>	<b>U208</b>	46,5	98	2800	3800
	78	28,5	1	<b>53308</b>	<b>U308</b>	68	135	2200	3200
	90	38,2	1,1	<b>53408</b>	<b>U408</b>	112	204	1700	2400

## Thrust Ball bearings, single direction, with Sphered Housing Washer

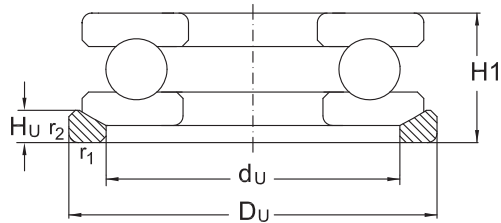

Dimensions									Mass	
d	D <sub>1</sub>	d <sub>1</sub>	R	A	d <sub>u</sub>	D <sub>u</sub>	H <sub>u</sub>	H <sub>1</sub>	Bearing	Seating Washer
mm									[kg]	
<b>10</b>	12	26	22	8,5	18	28	3,5	13	0,03	0,01
<b>12</b>	14	28	25	11,5	20	30	3,5	13	0,03	0,012
<b>15</b>	17	32	28	12	24	35	4	15	0,05	0,014
<b>17</b>	19	35	32	16	26	38	4	15	0,06	0,015
<b>20</b>	22	40	36	18	30	42	5	17	0,08	0,02
<b>25</b>	27	47	40	19	36	50	5,5	19	0,12	0,032
	27	52	45	21	38	55	6	22	0,18	0,044
	27	60	50	19	42	62	8	29	0,41	0,072
<b>30</b>	32	52	45	22	42	55	5,5	20	0,16	0,038
	32	60	50	22	45	62	7	25	0,27	0,056
	32	70	56	20	50	75	9	33	0,63	0,13
<b>35</b>	37	62	50	24	48	65	7	22	0,22	0,057
	37	68	56	24	52	72	7,5	28	0,38	0,084
	37	80	64	23	58	85	10	37	0,92	0,17
<b>40</b>	42	68	56	28,5	55	72	7	23	0,27	0,07
	42	78	64	28	60	82	8,5	31	0,55	0,12
	42	90	72	26	65	95	12	42	1,30	0,25



**Thrust Ball bearings, single direction, with Sphered Housing Washer**

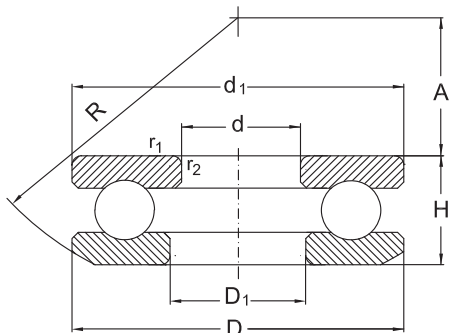

532/ 533/ 534

Dimension				Designation		Basical axial load		Speed limit	
d	D	H	r <sub>1</sub> , r <sub>2</sub> min.	Bearing	Seating Washer	dyn. C <sub>a</sub>	stat. C <sub>0a</sub>	grease	oil
mm						kN		min <sup>-1</sup>	
45	73	21,3	1	<b>53209</b>	<b>U209</b>	39	80	2600	3600
	85	30,1	1	<b>53309</b>	<b>U309</b>	75	140	2000	3000
	100	42,4	1,1	<b>53409</b>	<b>U409</b>	129	245	1600	2200
50	78	23,5	1	<b>53210</b>	<b>U210</b>	50	106	2400	3400
	95	34,3	1,1	<b>53310</b>	<b>U310</b>	88	173	1900	2800
	110	45,6	1,5	<b>53410</b>	<b>U410</b>	156	310	1500	2000
55	90	27,3	1	<b>53211</b>	<b>U211</b>	61	134	2200	3200
	105	39,3	1,1	<b>53311</b>	<b>U311</b>	102	208	1700	2400
	120	50,5	1,5	<b>53411</b>	<b>U411</b>	180	360	1300	1800
60	95	28	1	<b>53212</b>	<b>U212</b>	62	140	2000	3000
	110	38,3	1,1	<b>53312</b>	<b>U312</b>	102	208	1600	2200
	130	54	1,5	<b>53412 M</b>	<b>U412</b>	200	400	1200	1700
65	100	28,7	1	<b>53213</b>	<b>U213</b>	64	150	2000	3000
	115	39,4	1,1	<b>53313</b>	<b>U313</b>	106	220	1600	2200
	140	60,2	2	<b>53413 M</b>	<b>U413</b>	216	450	1100	1600
70	105	28,8	1	<b>53214</b>	<b>U214</b>	71	179	1900	2800
	125	44,2	1,1	<b>53314</b>	<b>U314</b>	137	300	1400	1900
	150	63,6	2	<b>53414 M</b>	<b>U414</b>	236	500	1100	1600

## Thrust Ball bearings, single direction, with Sphered Housing Washer

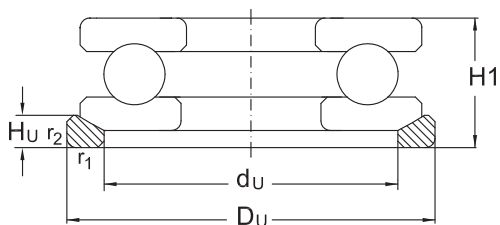

Dimensions									Mass	
d	D <sub>1</sub>	d <sub>1</sub>	R	A	d <sub>u</sub>	D <sub>u</sub>	H <sub>u</sub>	H <sub>1</sub>	Bearing	Seating Washer
mm									[kg]	
<b>45</b>	47	73	56	26	60	78	7,5	24	0,30	0,087
	47	85	64	25	65	90	10	33	0,66	0,17
	47	100	80	29	72	105	12,5	46	1,77	0,32
<b>50</b>	52	78	64	32,5	62	82	7,5	26	0,37	0,098
	52	95	72	28	72	100	11	37	0,97	0,23
	52	110	90	35	80	115	14	50	2,33	0,41
<b>55</b>	57	90	72	35	72	95	9	30	0,60	0,152
	57	105	80	30	80	110	11,5	42	1,38	0,28
	57	120	90	28	88	125	15,5	55	3,08	0,53
<b>60</b>	62	95	72	32,5	78	100	9	31	0,66	0,16
	62	110	90	41	85	115	11,5	42	1,41	0,31
	62	130	100	34	95	135	16	58	3,94	0,71
<b>65</b>	67	100	80	40	82	105	9	32	0,73	0,18
	67	115	90	38,5	90	120	12,5	43	1,53	0,34
	68	140	112	40	100	145	17,5	65	5,05	0,81
<b>70</b>	72	105	80	38	88	110	9	32	0,78	0,185
	72	125	100	43	98	130	13	48	2,10	0,41
	73	150	112	34	110	155	19,5	69	6,09	0,99



### Thrust Ball bearings, single direction, with Sphered Housing Washer

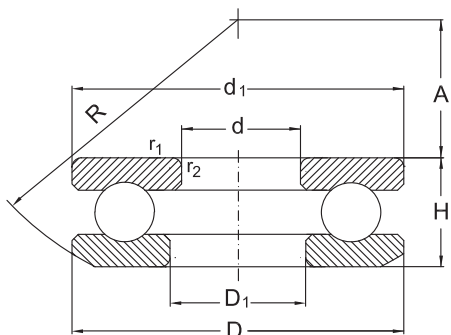

532/ 533/ 534

Dimension				Designation		Basical axial load		Speed limit	
d	D	H	r <sub>1</sub> , r <sub>2</sub> min.	Bearing	Seating Washer	dyn. C <sub>a</sub>	stat. C <sub>0a</sub>	grease	oil
mm						kN		min <sup>-1</sup>	
75	110	28,3	1	<b>53215</b>	<b>U215</b>	67	170	1900	2800
	135	48,1	1,5	<b>53315</b>	<b>U315</b>	163	360	1300	1800
	160	69	2	<b>53415 M</b>	<b>U415</b>	250	560	1000	1500
80	115	29,5	1	<b>53216</b>	<b>U216</b>	75	190	1800	2600
	140	47,6	1,5	<b>53316</b>	<b>U316</b>	160	360	1300	1800
	170	72,2	2,1	<b>53416 M</b>	<b>U416</b>	270	620	950	1400
85	125	33,1	1	<b>53217</b>	<b>U217</b>	98	250	1600	2200
	150	53,1	1,5	<b>53317</b>	<b>U317</b>	190	425	1200	1700
	180	77	2,1	<b>53417 M</b>	<b>U417</b>	290	680	900	1300
90	135	38,5	1,1	<b>53218</b>	<b>U218</b>	120	300	1500	2000
	155	54,6	1,5	<b>53318</b>	<b>U318</b>	196	465	1200	1700
	190	81,2	2,1	<b>53418 M</b>	<b>U418</b>	305	750	850	1300
100	150	40,9	1,1	<b>53220</b>	<b>U220</b>	122	320	1400	1900
	170	59,2	1,5	<b>53320</b>	<b>U320</b>	232	560	1100	1600
	210	90	3	<b>53420 M</b>	<b>U420</b>	565	965	750	1000
110	160	40,2	1,1	<b>53222</b>	<b>U222</b>	129	360	1300	1800
	190	67,2	2	<b>53322</b>	<b>U322</b>	275	720	950	1400
	230	99,7	3	<b>53422 M</b>	<b>U422</b>	415	1140	700	950

## Thrust Ball bearings, single direction, with Sphered Housing Washer

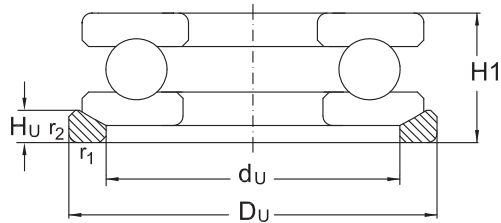

Dimensions									Mass	
d	D <sub>1</sub>	d <sub>1</sub>	R	A	d <sub>u</sub>	D <sub>u</sub>	H <sub>u</sub>	H <sub>1</sub>	Bearing	Seating Washer
mm									[kg]	
<b>75</b>	77	110	90	49	92	115	9,5	32	0,81	0,21
	77	135	100	37	105	140	15	52	2,67	0,55
	78	160	125	42	115	165	21	75	7,54	1,23
<b>80</b>	82	115	90	46	98	120	10	33	0,90	0,22
	82	140	112	50	110	145	15	52	2,77	0,57
	83	170	125	36	125	175	22	78	8,93	1,38
<b>85</b>	88	125	100	52	105	130	11	37	1,22	0,29
	88	150	112	43	115	155	17,5	58	3,53	0,81
	88	177	140	47	130	185	23	83	10,60	1,64
<b>90</b>	93	135	100	45	110	140	13,5	42	1,70	0,42
	93	155	112	40	120	160	18	59	3,83	0,84
	93	187	140	40	140	195	25,5	88	12,30	1,9
<b>100</b>	103	150	112	52	125	155	14	45	2,22	0,5
	103	170	125	46	135	175	18	64	4,98	0,95
	103	205	160	50	155	220	27	98	16,40	2,9
<b>110</b>	113	160	125	65	135	165	14	45	2,37	0,56
	113	187	140	51	150	195	20,5	72	7,83	1,28
	113	225	180	59	170	240	29	109	22,00	3,7



### Thrust Ball bearings, single direction, with Sphered Housing Washer

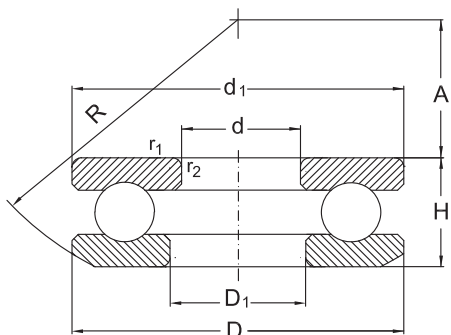

532/ 533/ 534

Dimension				Designation		Basical axial load		Speed limit	
d	D	H	r <sub>1</sub> , r <sub>2</sub> min.	Bearing	Seating Washer	dyn. C <sub>a</sub>	stat. C <sub>0a</sub>	grease	oil
mm						kN		min <sup>-1</sup>	
120	170	40,8	1,1	<b>53224</b>	<b>U224</b>	140	400	1200	1700
	210	74,1	2,1	<b>53324 M</b>	<b>U324</b>	325	915	850	1200
	250	107,3	4	<b>53424 M</b>	<b>U424</b>	425	1220	670	900
130	190	47,9	1,5	<b>53226</b>	<b>U226</b>	183	540	1100	1600
	225	80,3	2,1	<b>53326 M</b>	<b>U326</b>	360	1060	800	1100
	270	115,2	4	<b>53426 M</b>	<b>U426</b>	520	1600	600	800
140	200	48,6	1,5	<b>53228</b>	<b>U228</b>	190	570	1000	1500
	240	84,9	2,1	<b>53328 M</b>	<b>U328</b>	400	1220	750	1000
150	215	53,3	1,5	<b>53230 M</b>	<b>U230</b>	236	735	950	1400
	250	83,7	2,1	<b>53330 M</b>	<b>U330</b>	405	1290	700	950
160	225	54,7	1,5	<b>53232 M</b>	<b>U232</b>	245	780	950	1400
170	240	58,7	1,5	<b>53234 M</b>	<b>U234</b>	285	930	850	1200
180	250	58,2	1,5	<b>53236 M</b>	<b>U236</b>	290	1000	700	1100
190	270	65,7	2	<b>53238 M</b>	<b>U238</b>	335	1160	600	1000



## Thrust Ball bearings, single direction, with Sphered Housing Washer

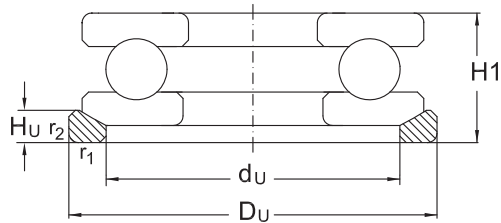

Dimensions									Mass	
d	D <sub>1</sub>	d <sub>1</sub>	R	A	d <sub>u</sub>	D <sub>u</sub>	H <sub>u</sub>	H <sub>1</sub>	Bearing	Seating Washer
mm									[kg]	
<b>120</b>	123	170	125	61	145	175	15	46	2,57	0,65
	123	205	160	63	165	220	22	80	10,60	2
	123	245	200	70	185	260	32	118	28,10	4,7
<b>130</b>	133	187	140	67	160	195	17	53	3,93	0,9
	134	220	160	53	177	235	26	86	12,90	2,5
	134	265	200	58	200	280	38	128	34,60	6,4
<b>140</b>	143	197	160	87	170	210	17	55	4,27	1,22
	144	235	180	68	190	250	26	92	15,60	2,9
<b>150</b>	153	212	160	79	180	225	20,5	60	5,81	1,69
	154	245	200	89,5	200	260	26	92	16,10	3,1
<b>160</b>	163	222	160	74	190	235	21	61	6,44	1,81
<b>170</b>	173	237	180	91	200	250	21,5	65	7,91	2,14
<b>180</b>	183	245	200	112	210	260	21,5	66	8,19	1,06
<b>190</b>	195	265	200	98	230	280	23	73	11,50	2,6



### Thrust Ball bearings, double direction, with Sphered Housing Washer

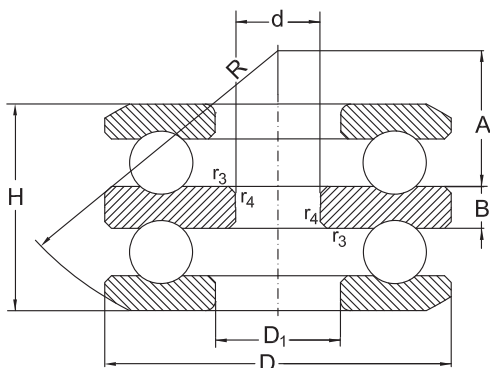

Shaft	Dimension				Designation		Basical axial load		Speed limit	
	d	D	H	r <sub>1</sub> , r <sub>2</sub> min.	r <sub>3</sub> , r <sub>4</sub> min.	Bearing	Seating Washer	dyn. C <sub>a</sub>	stat. C <sub>0a</sub>	grease
mm							kN		min <sup>-1</sup>	
<b>10</b>	32	24,6	0,6	0,3	<b>54202</b>	<b>U202</b>	16,6	25	5000	6700
<b>15</b>	40	27,4	0,6	0,3	<b>54204</b>	<b>U204</b>	22,4	37,5	4300	5600
	60	49,7	1	0,6	<b>54405</b>	<b>U405</b>	56	90	2600	3600
<b>20</b>	47	31,4	0,6	0,3	<b>54205</b>	<b>U205</b>	28	50	3800	5000
	52	37,6	1	0,3	<b>54305</b>	<b>U305</b>	34,5	55	3200	4300
	70	56,2	1	0,6	<b>54406</b>	<b>U406</b>	72	125	2200	3200
<b>25</b>	52	32,6	0,6	0,3	<b>54206</b>	<b>U206</b>	25,5	47,5	3600	4800
	60	41,3	1	0,3	<b>54306</b>	<b>U306</b>	38	65,5	3000	4000
	80	63,1	1,1	0,6	<b>54407</b>	<b>U407</b>	86,5	156	2000	3000
<b>30</b>	62	37,8	1	0,3	<b>54207</b>	<b>U207</b>	35,5	67	3000	4000
	68	38,6	1	0,6	<b>54208</b>	<b>U208</b>	46,5	98	2800	3800
	68	47,2	1	0,3	<b>54307</b>	<b>U307</b>	50	88	2600	3600
	78	54,1	1	0,6	<b>54308</b>	<b>U308</b>	61	112	2200	3200
	90	69,5	1,1	0,6	<b>54408</b>	<b>U408</b>	112	204	1700	2400
<b>35</b>	73	39,6	1	0,6	<b>54209</b>	<b>U209</b>	39	80	2600	3600
	85	56,3	1	0,6	<b>54309</b>	<b>U309</b>	75	140	2000	3000
	100	78,9	1,1	0,6	<b>54409</b>	<b>U409</b>	129	245	1600	2200
<b>40</b>	78	42	1	0,6	<b>54210</b>	<b>U210</b>	50	106	2400	3400

## Thrust Ball bearings, double direction, with Sphered Housing Washer

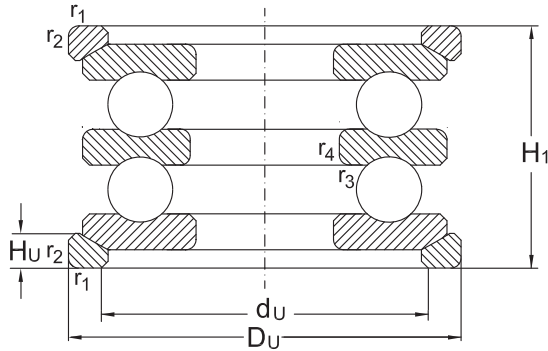

Dimensions									Mass	
d	D <sub>1</sub>	B	R	A	d <sub>u</sub>	D <sub>u</sub>	H <sub>u</sub>	H <sub>1</sub>	Bearing	Seating Washer
mm									[kg]	
<b>10</b>	17	5	28	10,5	24	35	4	28	0,09	0,01
<b>15</b>	22	6	36	16	30	42	5	32	0,15	0,02
	27	11	50	15	42	62	8	55	0,50	0,07
<b>20</b>	27	7	40	16,5	36	50	5,5	36	0,23	0,03
	27	8	45	18	38	55	6	42	0,32	0,04
	32	12	56	16	50	75	9	62	0,73	0,13
<b>25</b>	32	7	45	20	42	55	5,5	37	0,27	0,04
	32	9	50	19,5	45	62	7	46	0,47	0,06
	37	14	64	18,5	58	85	10	69	1,08	0,17
<b>30</b>	37	8	50	21	48	65	7	42	0,42	0,06
	42	9	56	25	55	72	7	44	0,56	0,07
	37	10	56	21	52	72	7,5	52	0,68	0,08
	42	12	64	23,5	60	82	8,5	59	1,06	0,12
	42	15	72	22	65	95	12	77	1,51	0,25
<b>35</b>	47	9	56	23	60	78	7,5	45	0,60	0,09
	47	12	64	21	65	90	10	62	1,24	0,17
	47	17	80	23,5	72	105	12,5	86	2,08	0,32
<b>40</b>	52	9	64	30,5	62	82	7,5	47	0,70	0,10



### Thrust Ball bearings, double direction, with Sphered Housing Washer

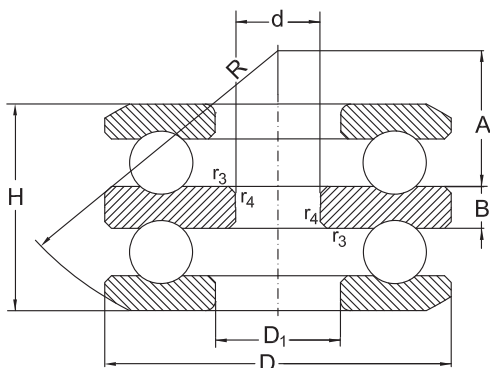

Shaft	Dimension				Designation		Basical axial load		Speed limit	
	d	D	H	r <sub>1</sub> , r <sub>2</sub> min.	r <sub>3</sub> , r <sub>4</sub> min.	Bearing	Seating Washer	dyn. C <sub>a</sub>	stat. C <sub>0a</sub>	grease
mm							kN		min <sup>-1</sup>	
40	95	64,7	1,1	0,6	<b>54310</b>	<b>U310</b>	88	173	1900	2800
	110	83,2	1,5	0,6	<b>54410</b>	<b>U410</b>	156	310	1500	2000
45	90	49,6	1	0,6	<b>54211</b>	<b>U211</b>	61	134	2200	3200
	105	72,6	1,1	0,6	<b>54311</b>	<b>U311</b>	102	208	1700	2400
	120	92	1,5	0,6	<b>54411</b>	<b>U411</b>	180	360	1300	1800
50	95	50	1	0,6	<b>54212</b>	<b>U212</b>	62	140	2000	3000
	110	70,7	1,1	0,6	<b>54312</b>	<b>U312</b>	102	208	1600	2200
	130	99	1,5	0,6	<b>54412</b>	<b>U412</b>	200	400	1200	1700
	140	109,4	2	1	<b>54413</b>	<b>U413</b>	216	450	1100	1600
55	100	50,4	1	0,6	<b>54213</b>	<b>U213</b>	64	150	2000	3000
	105	50,6	1	1	<b>54214</b>	<b>U214</b>	65,5	160	1900	2800
	115	71,9	1,1	0,6	<b>54313</b>	<b>U313</b>	106	220	1600	2200
	125	80,3	1,1	1	<b>54314</b>	<b>U314</b>	137	300	1400	1900
	150	114,1	2	1	<b>54414</b>	<b>U414</b>	236	500	1100	1600
60	110	49,6	1	1	<b>54215</b>	<b>U215</b>	67	170	1900	2800
	135	87,2	1,5	1	<b>54315</b>	<b>U315</b>	163	360	1300	1800
	160	123	2	1	<b>54415</b>	<b>U415</b>	250	560	1000	1500
65	115	51	1	1	<b>54216</b>	<b>U216</b>	75	190	1800	2600

## Thrust Ball bearings, double direction, with Sphered Housing Washer

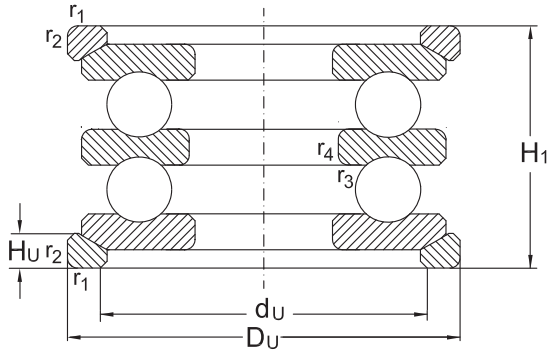

Dimensions									Mass	
d	D <sub>1</sub>	B	R	A	d <sub>u</sub>	D <sub>u</sub>	H <sub>u</sub>	H <sub>1</sub>	Bearing	Seating Washer
mm									[kg]	
40	52	14	72	23	72	100	11	70	1,83	0,23
	52	18	90	30	80	115	14	92	2,68	0,41
45	57	10	72	32,5	72	95	9	55	1,13	0,15
	57	15	80	25,5	80	110	11,5	78	2,54	0,28
	57	20	90	22,5	88	125	15,5	101	3,49	0,53
50	62	10	72	30,5	78	100	9	56	1,22	0,16
	62	15	90	36,5	85	115	11,5	78	2,62	0,31
	62	21	100	28	95	135	16	107	4,41	0,71
	68	23	112	34	100	145	17,5	119	5,67	0,81
55	67	10	80	38,5	82	105	9	57	1,33	0,18
	72	10	80	36,5	88	110	9	57	1,47	0,19
	67	15	90	34,5	90	120	12,5	79	2,82	0,34
	72	16	100	39	98	130	13	88	3,87	0,41
	73	24	112	28,5	110	155	19,5	125	6,77	0,99
60	77	10	90	47,5	92	115	9,5	57	1,54	0,21
	77	18	100	32,5	105	140	15	95	4,92	0,55
	78	26	125	36,5	115	165	21	135	8,33	1,23
65	82	10	90	45	98	120	10	58	1,70	0,22



### Thrust Ball bearings, double direction, with Sphered Housing Washer

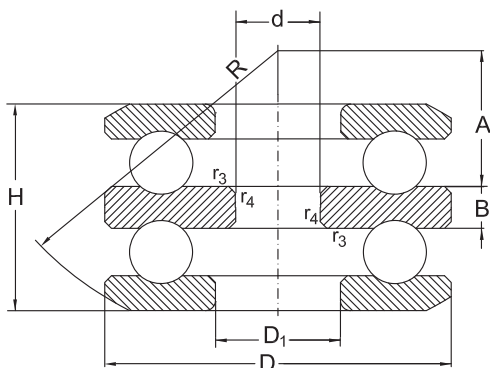

Shaft	Dimension				Designation		Basical axial load		Speed limit	
	d	D	H	r <sub>1</sub> , r <sub>2</sub> min.	r <sub>3</sub> , r <sub>4</sub> min.	Bearing	Seating Washer	dyn. C <sub>a</sub>	stat. C <sub>0a</sub>	grease
mm							kN		min <sup>-1</sup>	
65	140	86,1	1,5	1	<b>54316</b>	<b>U316</b>	160	360	1300	1800
	170	128,5	2,1	1	<b>54416</b>	<b>U416</b>	270	620	950	1400
	180	138	2,1	1,1	<b>54417</b>	<b>U417</b>	290	680	900	1300
70	125	59,2	1	1	<b>54217</b>	<b>U217</b>	98	250	1600	2200
	150	95,2	1,5	1	<b>54317</b>	<b>U317</b>	190	425	1200	1700
	190	143,5	2,1	1,1	<b>54418</b>	<b>U418</b>	305	750	850	1200
75	135	69	1,1	1	<b>54218</b>	<b>U218</b>	120	300	1500	2000
	155	97,1	1,5	1	<b>54318</b>	<b>U318</b>	196	465	1200	1700
80	210	159,9	3	1,1	<b>54420</b>	<b>U420</b>	365	965	750	1000
85	150	72,8	1,1	1	<b>54220</b>	<b>U220</b>	122	320	1400	1900
	170	105,4	1,5	1	<b>54320</b>	<b>U320</b>	132	560	1100	1600
95	160	71,4	1,1	1	<b>54222</b>	<b>U222</b>	129	360	1300	1800
	190	118,4	2	1	<b>54322 M</b>	<b>U322</b>	275	720	950	1400
100	170	71,6	1,1	1,1	<b>54224</b>	<b>U224</b>	140	400	1200	1700
	210	131,2	2,1	1,1	<b>54324 M</b>	<b>U324</b>	325	915	850	1200
110	190	85,8	1,5	1,1	<b>54226</b>	<b>U226</b>	183	540	1100	1600

## Thrust Ball bearings, double direction, with Sphered Housing Washer

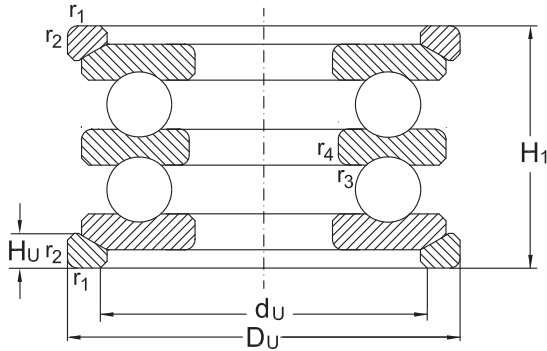

Dimensions									Mass	
d	D <sub>1</sub>	B	R	A	d <sub>u</sub>	D <sub>u</sub>	H <sub>u</sub>	H <sub>1</sub>	Bearing	Seating Washer
mm									[kg]	
<b>65</b>	82	18	112	45,5	110	145	15	95	5,05	0,57
	83	27	125	30,5	125	175	22	140	9,76	1,38
	88	29	140	40,5	130	185	23	150	8,64	1,64
<b>70</b>	88	12	100	49,5	105	130	11	67	2,39	0,29
	88	19	112	39	115	155	17,5	105	6,36	0,81
	93	30	140	34,5	140	195	25,2	157	13,60	1,90
<b>75</b>	93	14	100	42	110	140	13,5	76	3,27	0,42
	93	19	112	36,5	120	160	18	106	6,86	0,84
<b>80</b>	103	33	160	43,5	155	220	27	176	18,20	2,90
<b>85</b>	103	15	112	49	125	155	14	81	4,23	0,50
	103	21	125	42	135	175	18	115	8,99	0,95
<b>95</b>	113	15	125	62	135	165	14	81	4,57	0,56
	113	24	140	55	150	195	20,5	128	12,10	1,28
<b>100</b>	123	15	125	58,5	145	175	15	82	5,05	0,65
	123	27	160	58	165	220	22	143	19,10	2,00
<b>110</b>	133	18	140	63	160	195	17	96	7,78	0,90

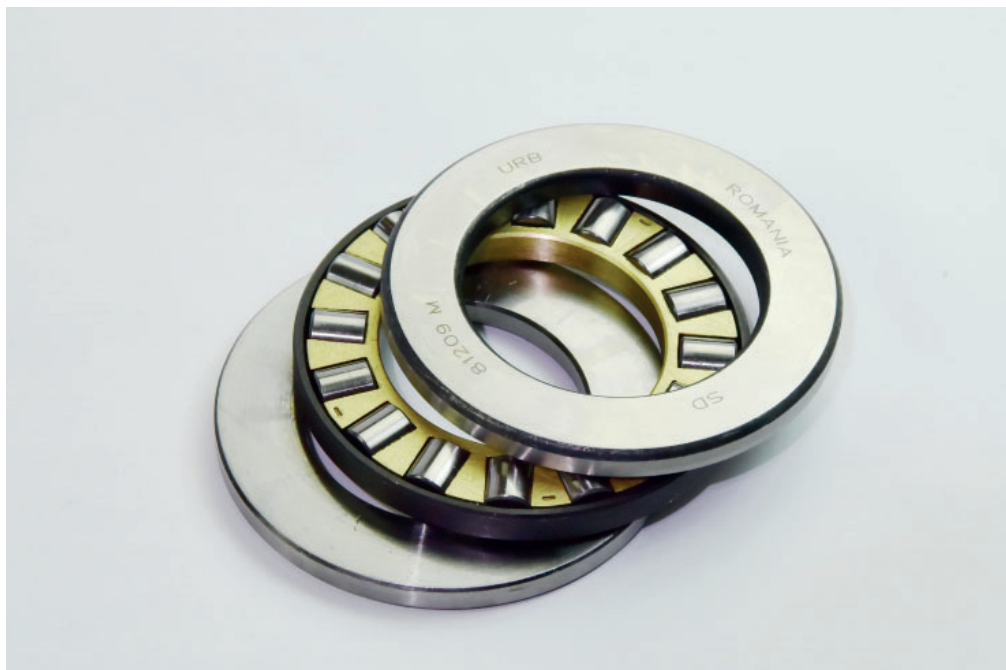



# Cylindrical Roller Thrust Bearings

## Standards, Boundary dimensions

Standard plans	DIN 616
Cylindrical roller thrust bearings	DIN 722

## General

Cylindrical Roller Thrust Bearings series 811 and 812 are single direction acting separable axial bearings.

Cylindrical roller thrust bearings are insensitive to shock loading and feature much higher load carrying capacity compared to thrust ball bearings. They accommodate very high axial loads but no radial forces. They provide a very rigid bearing assembly for high thrust loading with less space requirement.

Cylindrical roller thrust bearings are of simple design, they consist of a shaft washer (WS), a housing washer (GS), and a cylindrical roller and cage thrust assembly (K), see Abb. 1.

With all cylindrical roller thrust bearings, increased sliding friction can occur at the end of the cylindrical rollers.

In order to minimize this negative effect, URB cylindrical roller thrust bearings with wider sectional widths are produced using several short rollers in each cage pockets instead of using individual longer rollers.

Due to their specific kinematic behavior, cylindrical roller thrust bearings are only suitable for low speed applications only. Furthermore, they require minimal axial loads for their optimum function.

## Design variants

URB cylindrical roller thrust bearings are produced in single direction design only as standard (see Abb. 1a)

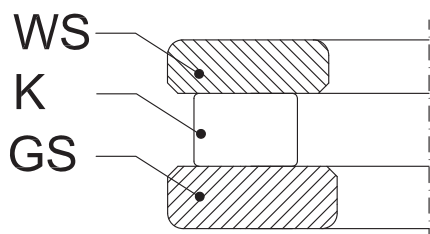

a

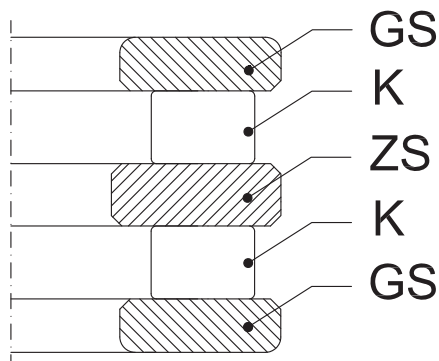

b



Double direction acting cylindrical roller thrust bearings are built using a combination of the components from single direction acting cylindrical roller thrust bearings together with intermediate washers ZS, (see Abb. 1 b).

Such intermediate washers are part of URB supplementary product range and are available on request. For application designs with space restrictions the cylindrical roller and cage thrust assemblies may be used without washers providing the contact faces of adjacent machine parts are machined as bearing raceways, (e.g. hardened and ground, etc.).

The components of cylindrical roller thrust bearing are frequently used either separately or in conjunction with other components in several applications (e.g. to build needle roller thrust assemblies) therefore, they are available as loose parts.

### Misalignment

All cylindrical roller thrust bearing type do not allow any misalignment.

The contacting surfaces of both shaft and housing seats must be parallel.

### Gages

Small URB cylindrical roller thrust bearings are fitted with shaft – centered polyamide cages as standard.

Polyamide cages are suitable for operating temperatures up to +120°C. Large cylindrical roller thrust bearings are produced with either solid brass cages (suffix MP), or with solid steel cages, (suffix FP).

### Tolerances

URB cylindrical roller thrust bearings are produced to normal class tolerance (PN) as standard.

For applications of higher accuracy these bearings are produced to precision tolerance class (e.g. P6) on order request. For detailed values of the tolerance

classes see chapter “Bearing tolerances” (see page 39-40).

### Minimum load:

All cylindrical roller thrust bearing require a certain minimum axial load to ensure a satisfactory operating function. To prevent excessive sliding friction, the minimum axial load applied should be greater than 5% of the axial bearing dynamic load rating  $C_a$ . Where such a minimum axial load is not possible the load must be increased by effective measures, (i.e. preloading the bearing) using pressure washers or springs.

### Equivalent dynamic bearing load

Cylindrical roller thrust bearings are pure axial bearings; they are not able to accommodate any radial loads, therefore:

$$P = F_a$$

### Equivalent static bearing load

For cylindrical roller thrust bearings:

$$P_0 = F_a$$

### Design of adjacent machine parts

When cylindrical roller and cage thrust assemblies are used without washers, adjacent machines parts must be designed and machined as bearing raceways (e.g. hardened and ground etc.). The maximum permissible axial runout of the adjacent surfaces acting as raceway must also meet the requirements of the respective washers. The bore diameters of URB cylindrical roller and cage thrust assemblies have tolerances according to ISO Tolerance field (E11), whilst the tolerance of their outer diameters lies in the tolerance field (a13).

Cylindrical roller and cage thrust assemblies require an effective guidance when operating at

higher speeds.

To avoid excessive wear, at higher speeds, the guiding surface must be ground.

### **Bearing seats for cylindrical roller thrust bearings**

For the design of cylindrical roller thrust bearing seats the following of tolerance fields have proven to be satisfactory in practice:

Centered at	Tolerance field	
	Shaft	Housing
Cylindrical roller and thrust assembly	h8	H9
Shaft washer	h6	-
Housing washer	-	H7

### **Abutment and Fillet dimensions for cylindrical roller thrust bearings**

In case of cylindrical roller thrust bearings, an effective support of the bearing washers over the total width of their raceways by adjacent machine parts is necessary.

The bearing washer must contact adjacent parts with their side face only. The fillet radii of bearing corners must not touch the shoulder fillet radii of the shaft or housing shoulders.

Therefore, the largest fillet radius ( $r_g$ ) must be smaller than the minimum fillet dimension of the bearing rings ( $r_f$ ) as listed in the following tables.



**Abutment and Fillet dimensions for cylindrical roller thrust bearings, series 811 and 812 [mm]**

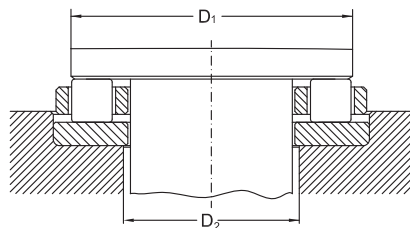
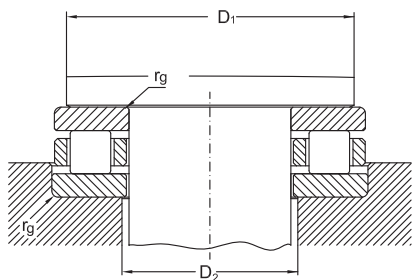

Shaft $\varnothing d$	Bore reference number	Bearing Series					
		811			812		
		$D_1$ min	$D_2$ min	$r_g$ max	$D_1$ min	$D_2$ min	$r_g$ max
mm							
15	2	25	18	0,3	-	-	-
17	3	27	20	0,3	-	-	-
20	4	32	23	0,3	-	-	-
25	5	39	28	0,6	-	-	-
30	6	44	33	0,6	49	33	0,6
35	7	49	38	0,6	56	41	1
40	8	56	44	0,6	63	45	1
45	9	61	49	0,6	68	50	1
50	10	66	54	0,6	73	55	1
55	11	73	60	0,6	84	61	1
60	12	80	65	1	89	66	1
65	13	85	70	1	94	71	1
70	14	90	75	1	99	76	1
75	15	95	80	1	104	81	1
80	16	100	85	1	109	86	1
85	17	105	90	1	117	93	1
90	18	114	96	1	127	98	1
100	20	129	106	1	140	110	1
110	22	139	116	1	150	120	1
120	24	149	126	1	160	130	1
130	26	162	138	1	179	141	1,5
140	28	172	148	1	189	151	1,5
150	30	182	158	1	204	161	1,5

## Abutment and Fillet dimensions for cylindrical roller thrust bearings, series 811 and 812 [mm]

Shaft $\emptyset d$	Bore reference number	Bearing Series					
		811			812		
		$D_1$ min	$D_2$ min	$r_g$ max	$D_1$ min	$D_2$ min	$r_g$ max
mm							
<b>160</b>	<b>32</b>	192	168	1	214	171	1,5
<b>170</b>	<b>34</b>	207	178	1	227	183	1,5
<b>180</b>	<b>36</b>	217	188	1	237	193	1,5
<b>190</b>	<b>38</b>	230	200	1	256	204	2
<b>200</b>	<b>40</b>	240	210	1	266	214	2
<b>220</b>	<b>44</b>	260	230	1	286	234	2
<b>240</b>	<b>48</b>	288	252	1,5	322	258	2,1
<b>260</b>	<b>52</b>	308	272	1,5	342	278	2,1
<b>280</b>	<b>56</b>	337	293	1,5	362	298	2,1
<b>300</b>	<b>60</b>	365	315	2	398	322	2,5
<b>320</b>	<b>64</b>	385	335	2	418	342	2,5
<b>340</b>	<b>68</b>	405	355	2	438	362	2,5
<b>360</b>	<b>72</b>	425	375	2	475	385	3
<b>380</b>	<b>76</b>	445	395	2	495	405	3
<b>400</b>	<b>80</b>	465	415	2	515	425	3
<b>420</b>	<b>84</b>	485	435	2	552	448	4
<b>440</b>	<b>88</b>	522	458	2,1	572	468	4
<b>460</b>	<b>92</b>	542	478	2,1	592	488	4
<b>480</b>	<b>96</b>	562	498	2,1	621	509	4
<b>500</b>	<b>/500</b>	582	518	2,1	641	529	4
<b>530</b>	<b>/530</b>	619	551	2,5	680	560	4
<b>560</b>	<b>/560</b>	649	581	2,5	715	595	4
<b>600</b>	<b>/600</b>	689	621	2,5	764	636	4



## Cylindrical Roller Thrust Bearings

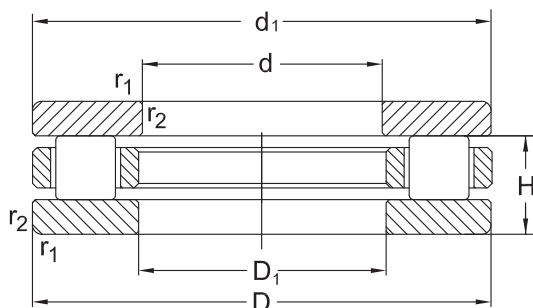

Dimension				Designation	Basical axial load		Speed limit	
d	D	H	$r_1, r_2$ min.		dyn. $C_a$	stat. $C_{0a}$	grease	oil
mm					kN		$\text{min}^{-1}$	
30	47	11	0,6	<b>81106</b>	28	83	2600	6700
	52	16	0,6	<b>81206</b>	50	132	2400	6300
35	52	12	0,6	<b>81107</b>	30	93	2200	6000
	62	18	1	<b>81207</b>	54	156	1900	5300
40	60	13	0,6	<b>81108</b>	42,5	137	1900	5300
	68	19	1	<b>81208</b>	76,5	220	1700	4800
45	65	14	0,6	<b>81109</b>	45	150	1700	4800
	73	20	1	<b>81209</b>	83	255	1600	4500
50	70	14	0,6	<b>81110</b>	42,5	143	1500	4300
	78	22	1	<b>81210</b>	88	285	1400	4000
55	78	16	0,6	<b>81111</b>	52	193	1400	4000
	90	25	1	<b>81211</b>	122	390	1200	3600
60	85	17	1	<b>81112</b>	73,5	265	1200	3600
	95	26	1	<b>81212</b>	114	335	1100	3400
65	90	18	1	<b>81113</b>	76,5	285	1100	3400
	100	27	1	<b>81213</b>	118	390	950	3000
70	95	18	1	<b>81114</b>	71	265	1000	3200
	105	27	1	<b>81214</b>	122	440	950	3000
75	100	19	1	<b>81115</b>	75	285	950	3000
	110	27	1	<b>81215</b>	125	440	900	2800
80	105	19	1	<b>81116</b>	76,5	300	900	2800
	115	28	1	<b>81216</b>	129	455	850	2600

## Cylindrical Roller Thrust Bearings

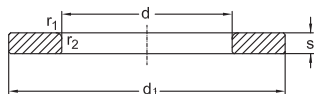

WS 8...

Abutment and fillet dimensions  
see on page 488

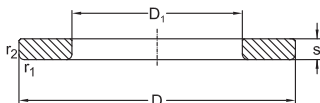

GS 8...

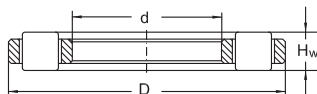

K 8...

Dimensions				Designation of Bearing Components			Mass
d	d <sub>1</sub>	D <sub>1</sub>	S	Cylindrical Roller and Cage thrust assembly	Shaft Washer	Housing Washer	
mm							[kg]
30	47	32	3	K81106	WS81106	GS81106	0,06
	52	32	4,25	K81206	WS81206	GS81206	0,13
35	52	37	3,5	K81107	WS81107	GS81107	0,08
	62	37	5,25	K81207	WS81207	GS81207	0,23
40	60	42	3,5	K81108	WS81108	GS81108	0,12
	68	42	5	K81208	WS81208	GS81208	0,27
45	65	47	4	K81109	WS81109	GS81109	0,14
	73	47	5,5	K81209	WS81209	GS81209	0,31
50	70	52	4	K81110	WS81110	GS81110	0,16
	78	52	6,5	K81210	WS81210	GS81210	0,38
55	78	57	5	K81111	WS81111	GS81111	0,23
	90	57	7	K81211	WS81211	GS81211	0,60
60	85	62	4,75	K81112	WS81112	GS81112	0,28
	95	62	7,5	K81212	WS81212	GS81212	0,74
65	90	67	5,25	K81113	WS81113	GS81113	0,33
	100	67	8	K81213	WS81213	GS81213	0,82
70	95	72	5,25	K81114	WS81114	GS81114	0,36
	105	72	8	K81214	WS81214	GS81214	0,87
75	100	77	5,75	K81115	WS81115	GS81115	0,43
	110	77	8	K81215	WS81215	GS81215	0,92
80	105	82	5,75	K81116	WS81116	GS81116	0,46
	115	82	8,5	K81216	WS81216	GS81216	1,02



## Cylindrical Roller Thrust Bearings

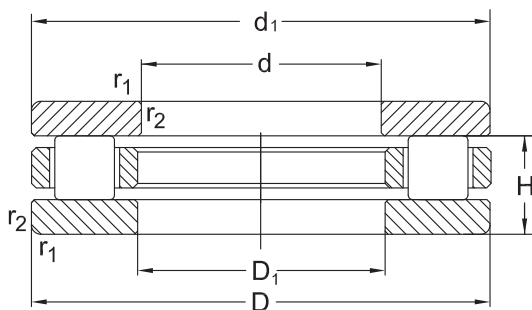

Dimension				Designation	Basical axial load		Speed limit	
d	D	H	$r_1, r_2$ min.		dyn. $C_a$	stat. $C_{0a}$	grease	oil
mm					kN		$\text{min}^{-1}$	
85	110	19	1	<b>81117</b>	76,5	310	850	2600
	125	31	1	<b>81217</b>	153	550	800	2400
90	120	22	1	<b>81118</b>	104	415	800	2400
	135	35	1,1	<b>81218</b>	190	670	800	2400
100	135	25	1	<b>81120</b>	146	585	750	2200
	150	38	1,1	<b>81220</b>	224	815	700	2000
110	145	25	1	<b>81122</b>	160	655	700	2000
	160	38	1,1	<b>81222</b>	232	865	670	1900
120	155	25	1	<b>81124</b>	160	680	670	1900
	170	39	1,1	<b>81224</b>	245	950	630	1800
130	170	30	1	<b>81126</b>	186	780	600	1700
	190	45	1,5	<b>81226</b>	365	1400	560	1600
140	180	31	1	<b>81128</b>	196	865	560	1600
	200	46	1,5	<b>81228</b>	375	1460	530	1500
150	190	31	1	<b>81130</b>	204	930	530	1500
	215	50	1,5	<b>81230</b>	455	1800	500	1400
160	200	31	1	<b>81132</b>	212	980	500	1400
	225	51	1,5	<b>81232</b>	465	1900	500	1400
170	215	34	1,1	<b>81134</b>	265	1220	500	1400
	240	55	1,5	<b>81234</b>	520	2080	480	1300
180	225	34	1,1	<b>81136</b>	275	1290	480	1300
	250	56	1,5	<b>81236</b>	520	2160	450	1200



## Cylindrical Roller Thrust Bearings

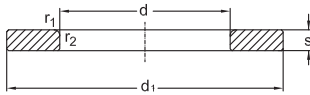

WS 8...

Abutment and fillet dimensions  
see on page 488

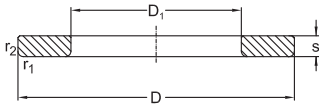

GS 8...

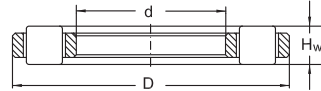

K 8...

Dimensions				Designation of Bearing Components			Mass [kg]
d	d <sub>1</sub>	D <sub>1</sub>	S	Cylindrical Roller and Cage thrust assembly	Shaft Washer	Housing Washer	
mm							
85	110	87	5,75	<b>K81117</b>	<b>WS81117</b>	<b>GS81117</b>	0,48
	125	88	9,5	<b>K81217</b>	<b>WS81217</b>	<b>GS81217</b>	1,36
90	120	92	6,5	<b>K81118</b>	<b>WS81118</b>	<b>GS81118</b>	0,72
	135	93	10,5	<b>K81218</b>	<b>WS81218</b>	<b>GS81218</b>	1,85
100	135	102	7	<b>K81120</b>	<b>WS81120</b>	<b>GS81120</b>	1,07
	150	103	11,5	<b>K81220</b>	<b>WS81220</b>	<b>GS81220</b>	2,45
110	145	112	7	<b>K81122</b>	<b>WS81122</b>	<b>GS81122</b>	1,12
	160	113	11,5	<b>K81222</b>	<b>WS81222</b>	<b>GS81222</b>	2,70
120	155	122	7	<b>K81124</b>	<b>WS81124</b>	<b>GS81124</b>	1,25
	170	123	12	<b>K81224</b>	<b>WS81224</b>	<b>GS81224</b>	2,98
130	170	132	9	<b>K81126</b>	<b>WS81126</b>	<b>GS81126</b>	1,72
	187	133	13	<b>K81226</b>	<b>WS81226</b>	<b>GS81226</b>	4,37
140	178	142	9,5	<b>K81128</b>	<b>WS81128</b>	<b>GS81128</b>	2,02
	197	143	13,5	<b>K81228</b>	<b>WS81228</b>	<b>GS81228</b>	4,76
150	188	152	9,5	<b>K81130</b>	<b>WS81130</b>	<b>GS81130</b>	2,15
	212	153	14,5	<b>K81230</b>	<b>WS81230</b>	<b>GS81230</b>	6,04
160	198	162	9,5	<b>K81132</b>	<b>WS81132</b>	<b>GS81132</b>	2,28
	222	163	15	<b>K81232</b>	<b>WS81232</b>	<b>GS81232</b>	6,52
170	213	172	10	<b>K81134</b>	<b>WS81134</b>	<b>GS81134</b>	3,01
	237	173	16,5	<b>K81234</b>	<b>WS81234</b>	<b>GS81234</b>	8,12
180	222	183	10	<b>K81136</b>	<b>WS81136</b>	<b>GS81136</b>	3,07
	247	183	17	<b>K81236</b>	<b>WS81236</b>	<b>GS81236</b>	8,69



## Cylindrical Roller Thrust Bearings

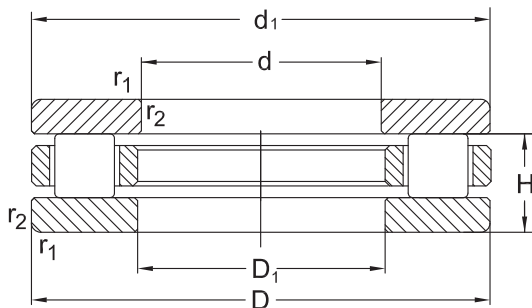

Dimension				Designation	Basical axial load		Speed limit	
d	D	H	$r_1, r_2$ min.		dyn. $C_a$	stat. $C_{0a}$	grease	oil
mm					kN		$\text{min}^{-1}$	
<b>190</b>	240	37	1,1	<b>81138</b>	315	1500	450	1200
	270	62	2	<b>81238</b>	655	2650	430	1100
<b>200</b>	250	37	1,1	<b>81140</b>	325	1600	450	1200
	280	62	2	<b>81240</b>	695	2900	430	1100
<b>220</b>	270	37	1,1	<b>81144</b>	355	1830	430	1100
	300	63	2	<b>81244</b>	735	3200	400	1000
<b>240</b>	300	45	1,5	<b>81148</b>	465	2360	380	950
	340	78	2,1	<b>81248</b>	980	4250	360	900
<b>260</b>	320	45	1,5	<b>81152</b>	500	2650	360	900
	360	79	2,1	<b>81252</b>	1040	4650	340	850
<b>280</b>	350	53	1,5	<b>81156</b>	670	3450	340	850
	380	80	2,1	<b>81256</b>	1060	4900	320	800
<b>300</b>	380	62	2	<b>81160</b>	800	4000	300	750
	420	95	3	<b>81260</b>	1400	6200	280	700
<b>360</b>	440	65	2	<b>81172</b>	900	4900	240	630
	500	110	4	<b>81272</b>	1960	9150	220	600
<b>380</b>	460	65	2	<b>81176</b>	880	4900	240	630
	520	112	4	<b>81276</b>	2000	9500	200	560

## Cylindrical Roller Thrust Bearings

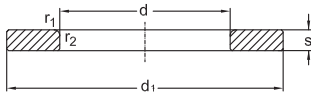

WS 8...

Abutment and fillet dimensions  
see on page 488

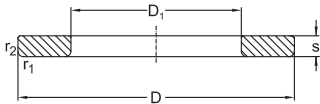

GS 8...

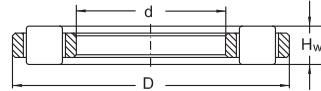

K 8...

Dimensions				Designation of Bearing Components			Mass [kg]
d	d <sub>1</sub>	D <sub>1</sub>	S	Cylindrical Roller and Cage thrust assembly	Shaft Washer	Housing Washer	
mm							
190	237	193	11	<b>K81138</b>	<b>WS81138</b>	<b>GS81138</b>	3,99
	267	194	18	<b>K81238</b>	<b>WS81238</b>	<b>GS81238</b>	11,70
200	247	203	11	<b>K81140</b>	<b>WS81140</b>	<b>GS81140</b>	4,17
	277	204	18	<b>K81240</b>	<b>WS81240</b>	<b>GS81240</b>	12,2
220	267	223	11	<b>K81144</b>	<b>WS81144</b>	<b>GS81144</b>	4,65
	297	224	18,5	<b>K81244</b>	<b>WS81244</b>	<b>GS81244</b>	13,4
240	297	243	13,5	<b>K81148</b>	<b>WS81148</b>	<b>GS81148</b>	7,43
	335	244	23	<b>K81248</b>	<b>WS81248</b>	<b>GS81248</b>	23,10
260	317	263	13,5	<b>K81152</b>	<b>WS81152</b>	<b>GS81152</b>	7,99
	355	264	23,5	<b>K81252</b>	<b>WS81252</b>	<b>GS81252</b>	25,1
280	347	283	15,5	<b>K81156</b>	<b>WS81156</b>	<b>GS81156</b>	12
	375	284	24	<b>K81256</b>	<b>WS81256</b>	<b>GS81256</b>	27,1
300	376	304	18,5	<b>K81160</b>	<b>WS81160</b>	<b>GS81160</b>	17,2
	415	304	28,5	<b>K81260</b>	<b>WS81260</b>	<b>GS81260</b>	42,50
360	436	364	20	<b>K81172</b>	<b>WS81172</b>	<b>GS81172</b>	21,4
	495	365	32,5	<b>K81272</b>	<b>WS81272</b>	<b>GS81272</b>	68,7
380	456	384	20	<b>K81176</b>	<b>WS81176</b>	<b>GS81176</b>	22,4
	515	385	33,5	<b>K81276</b>	<b>WS81276</b>	<b>GS81276</b>	73,3



## Cylindrical roller thrust bearings, single direction Non standardized

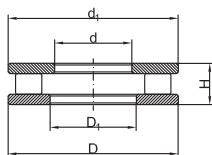

Fig. 1

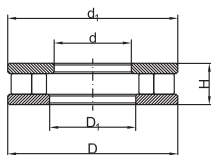

Fig. 2

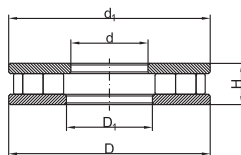

Fig. 3

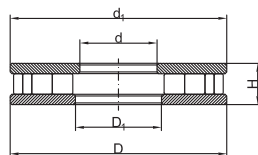

Fig. 4

Dimensions						Fig.	Basic axial load		Speed limit		Designation	Mass
d	D	H	$r_s$ min.	$d_1$	$D_1$		dyn $C_a$	stat. $C_{0a}$	grease	oil		
mm							kN		$min^{-1}$			
25	49	15	0,6	49	25,2	1	37,1	92,7	3400	4800	<b>85205 M</b>	0,131
	52	18	0,5	52	25,2	1	36,8	92,4	3000	4300	<b>85105 M</b>	0,181
34,925	79	15,875	1,5	78	37	2	80	316	2200	3200	<b>892007 M</b>	0,43
40	91.035	15,5	0,3	87	45	3	92	378	2400	3400	<b>85108M</b>	0,500
	105	16	0,5	105	48	10	141	591	2800	4000	<b>86208 M</b>	0,859
46	112.035	19	0,3	105	53	3	139	591	2000	2800	<b>85109 M</b>	1,04
50	105	20	0,5	105,5	54,5	9	172	776	2300	3300	<b>85110 TN</b>	0,655
	105	16	0,5	105,5	52	8	172	776	2800	4000	<b>85210 TN</b>	0,633
62	138,04	22	0,6	134	70	3	215	950	1700	2400	<b>85112M</b>	1,87
70	95	6	0,3	-	72	1	46,2	234	3400	4800	<b>85114M</b>	0,154
76,2	228,6	35	1	227	77,7	1	436	1996	1000	1500	<b>85115M</b>	7,64
85	110	6	0,3	-	87	7	50	274	3000	4300	<b>85117 M</b>	0,18
96,15 <sup>1)</sup>	181,6 <sup>1)</sup>	17,2	0,3	175,05	96,15	4	286	1774	1700	2400	<b>85119M</b>	2,39
100	210	67	3	208,5	103	2	669	2711	750	1100	<b>85320 M</b>	12,7
160	345	120	4	314	160,3	2	1836	7603	450	630	<b>85132 M</b>	66,8
200	280	62	2	277	204	1	735	3146	700	1000	<b>81240 M</b>	66,8
210	420	120	4	420	212	2	2380	11616	400	560	<b>85142 M</b>	95,6
	460	120	4	460	212	3	2500	12144	380	530	<b>85242 M</b>	117
240	540	125 <sup>1)</sup>	5	540	242	4	5308	34918	360	500	<b>85148M</b>	248
270	520	125	5	520	274	3	8239	16840	360	500	<b>85154 M</b>	148
272	480	132	5	480	274	3	2681	13010	360	500	<b>85254 M</b>	122
280	520	145	6	520	284	3	3296	16005	340	480	<b>85156 M</b>	160
340	620	170	6	620	344	3	4258	20698	280	400	<b>85168M</b>	265

[1] Cage diameters: dc=82; Dc=181,6

[2] Available with compensator ring, h=55

## Cylindrical roller thrust bearings, single direction

Non standardized

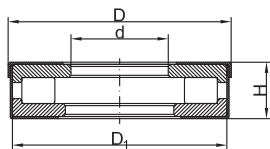

Fig. 5

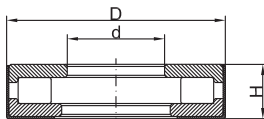

Fig. 6

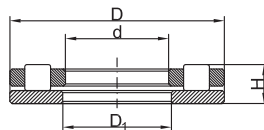

Fig. 7

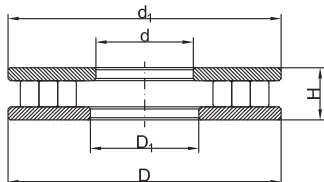

Fig. 8

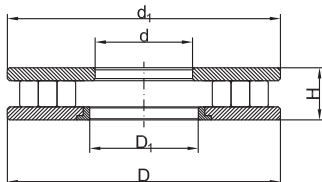

Fig. 9

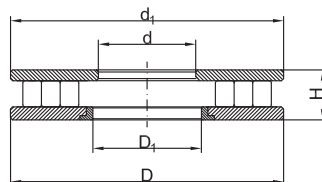

Fig. 10

Dimensions							Fig.	Basic axial load		Speed limit		Designation	Mass
d	D	H	r <sub>s</sub> min.	r <sub>1s</sub> min.	d <sub>1</sub>	D <sub>1</sub>		dyn c <sub>a</sub>	stat. C <sub>0a</sub>	grease	oil	Bearing	
mm								kN		min <sup>-1</sup>			kg
<b>22,45</b>	48,02	15,9	0,3				6	38,5	87,1	2500	3200	<b>851Z04</b>	0,222
<b>25,8</b>	50,5	15,9	0,3				6	41	97	2400	3400	<b>861Z05</b>	0,139
<b>32</b>	61	17				55	5	27,3	72,6	2600	3800	<b>851Z06</b>	0,20
	61	17				55	5	27,3	72,6	2600	3800	<b>851Z06TN</b>	0,20
<b>39</b>	73	20,5				69,5	6	67,7	190	2200	3200	<b>851Z08</b>	0,38
<b>44</b>	110	20		0,5	105	50	10	141	591	2300	3300	<b>86108M</b>	1,147
<b>50.952</b>	74,74	15.875	0,6				6	52,2	155	2400	3600	<b>851Z10</b>	0,217
<b>70</b>	95	6	0,3		95	72	7	46	234	4900	7000	<b>890614M</b>	0,154
<b>85</b>	110	6	0,3		110	87	7	50	273	4900	7000	<b>890717M</b>	0,180



**Cylindrical roller thrust bearings, double direction**  
Non standardized

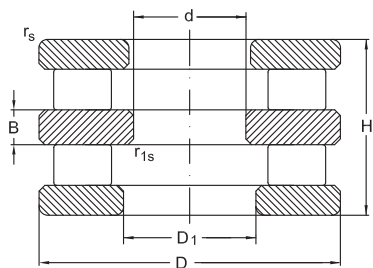

fig. 1

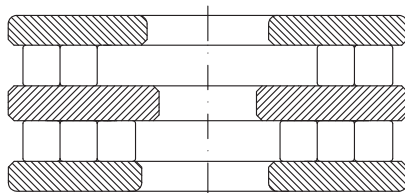

fig. 2

Dimensions							Fig.	Basic axial load		Speed limit		Designation	Mass
d	D	H	B	r <sub>s</sub> min.	r <sub>1s</sub> min.	D1		dyn C <sub>a</sub>	stat. C <sub>0a</sub>	grease	oil		
mm								kN		min <sup>-1</sup>		kg	
<b>35</b>	71,85	33	8	1	1	62	1	44	118	2800	4000	<b>86107</b>	0,535
<b>85</b>	230	100	29	1,5	1,5	113	2	626	3086	700	1000	<b>86117M</b>	21,82
<b>140</b>	200	72	19	1	1	154	1	253	1061	900	1300	<b>86228 M</b>	6,87
<b>141</b>	200	68	24	1	1	162,4	-	192	878	900	1300	<b>86128 M</b>	6.392
<b>150</b>	215	78	20	0,6	0,6	166	-	287	1217	900	1300	<b>86130 M</b>	8,82
<b>210</b>	400	262,7	95	3	3	242	-	2390	7770	430	630	<b>86142 M</b>	157

## Cylindrical roller and cage thrust assemblies

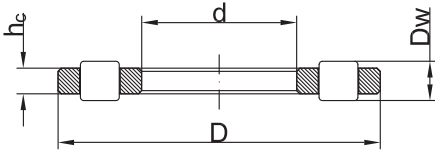

Fig. 3

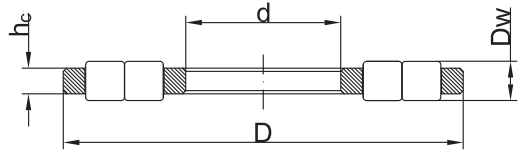

Fig. 4

Dimensions				Fig.	Basic axial load		Speed limit		Designation	Mass
d	D	D <sub>w</sub>	h <sub>c</sub>		dyn C <sub>a</sub>	stat. C <sub>0a</sub>	grease	oil	Bearing	
mm					kN		min <sup>-1</sup>			kg
<b>30,04</b>	60	5,5	3,75	4	51,3	176	4000	5600	<b>K89306 M</b>	0,066
<b>35,05</b>	68	6	4,2	4	59	214	3100	4400	<b>K89307 M</b>	0,096
<b>40,05</b>	81	7	5	4	88,6	333	3000	4300	<b>K85108 TN</b>	0,084
<b>60,06</b>	85	7,5	5,2	3	71,7	257	2800	4000	<b>K81112M</b>	0,129
<b>65,06</b>	90	7,5	5,2	3	72,8	268	2600	3800	<b>K81113M</b>	0,134
<b>70,05</b>	100	11	7,5	3	127	432	2200	3000	<b>K81214M</b>	0,319
<b>75</b>	169	19	15,5	4	480	1806	1300	1800	<b>K891215M</b>	2,35
<b>75,06</b>	100	7,5	5,75	3	68,7	268	2000	2800	<b>K81115M</b>	0,146
<b>85</b>	179	19	15,5	4	501	1956	1200	1700	<b>K891117M</b>	2,54
<b>90,06</b>	120	9	6,5	3	106	416	1500	2200	<b>K81115M</b>	0,209





# Support rollers

## Standards, Boundary dimensions

Standard plans DIN 616

### General

**Support Rollers** are cylindrical roller bearings with an extra radially thick outer ring.

**Support Rollers** usually run with their outer ring either directly on a guide track or against a machine surface that is for guidance. Due to their extra - thick outer rings, support rollers are able to accept high radial forces as well as shock loads. Their ability to accommodate axial forces, however, depends on the particular design of the support roller. Support rollers are usually exposed to minor misalignments during operation. To minimize the negative effects of such misalignments, (e.g. high edge stresses), support rollers are more frequently used with sphered outer rings.

**URB - support rollers** with parallel (cylindrical) outer diameters are indicated by the suffix "X".

### Design variants

To provide simple re-lubrication, all support rollers have lubrication holes in their inner rings. For the most common design are shown in the figures on the pages 503.

### Support Rollers with axial guidance

These types of supporting rollers are also to accommodate additional thrust loads as they occur, due to aligning errors or if rollers run out of line. That is why no extra external guiding surfaces are required.

Where high axial loads are anticipated effective axial support of side washers must be achieved by the adjacent machine components.

## NUTR - type support rollers

The base internal design of **NUTR** - type support rollers is similar to that of double row cylindrical roller bearings. Since the outer ring has two shoulders these support rollers are able to accommodate greater thrust loads.

**NUTR** - type support rollers are non-separable. The separate loose ribs of these types are retained using either cupped washers press - fitted into the outer ring or with lamellar rings which sit in the formed circumferential grooves machined in the loose rib outer diameter. Both methods also act as a gap seal. Due to do their full complement design, **NUTR** - type support roller feature a maximum load rating but they must be more frequently re-lubrication. For extra heavy duty applications, particularly where heavy shock loads occurs **NUTR** - type support rollers are available with an extra - radially thick walled outer ring (see sketch).

**URB's** extra - heavy - duty **NUTR** - type support rollers with increased outer ring wall thickness are identified by the fact that their nominal diameters are included in their designation.

Examples: **NUTR 1747** or **NUTR 50110**.



All **URB support rollers are produced with crowned outer ring diameter as standard** they are also available with parallel (cylindrical) outer diameters indicated by the suffix “X” see the relevant designs.

**Grease filling**

All **URB Support rollers** are already supplied filled with a high quality, lithium - soaped bearing grease as standard. This lubricant is adequate for operating temperatures of -30°C up to ca. +110°C. Although support rollers under normal operating

- standard DIN 620. The exceptions being the outer ring outer diameter tolerance of crowned outer rings and the width tolerance of supporting roller **NUTR**. The tolerance for the outer ring diameter of support rollers with sphered outer ring is uniform at: **0 / -0,05 mm**.

The width tolerance of support rollers of series **NUTR** is lateral and lies in the ISO – tolerance field **h12**.

Values of ISO – tolerance field F6 and h12 are listed in the table below. For detailed values of tolerances to DIN 620 see chapter “**Bearing tolerances**” page 26.

Tolerance values of ISO - tolerance fields F6 and h12 [µm]								
Nominal dimension	[mm]	>	3	6	10	18	30	50
		≤	6	10	18	30	50	80
<b>ISO - Tolerance field</b>	<b>F6</b>	min	10	13	16	20	25	30
		max	18	22	27	33	41	49
<b>ISO - Tolerance field</b>	<b>h12</b>	min	-120	-150	-180	-210	-250	-300
		max	0	0	0	0	0	0

conditions usually run maintenance - free, they may require more frequent re - lubrication under certain un-favorable operating conditions such as heavy dust, high speeds, permanent operating temperatures of more than 70°C, and the presence of increased humidity etc.

Therefore a **URB support rollers** feature a lubrication hole in the inner ring to provide the possibility of re-lubricating the rollers, when necessary.

It must be considered where re-lubrication is necessary; to be done with satisfactory type of grease, the force of pressure to re-grease must be of a level not to cause permanent damage to either the seals or shields.

**URB** also produce roller with alternative grease fill according to customer’s specification upon order request.

**Tolerances**

**URB** support rollers are produced to normal tolerance class (**PN**) as standard, according to DIN

**Internal Clearance**

**URB Support rollers** are produced to normal internal clearance group (**CN**) as standard according to DIN 620.

**Load carrying capability**

Unlike “normal” rolling element bearings, the outer ring of support rollers contact the adjacent parts with a very small contacting surface only.

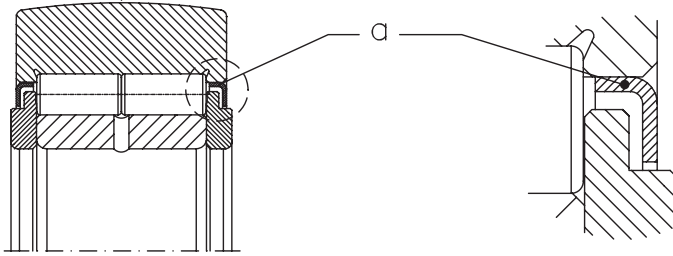

NUTR (a)

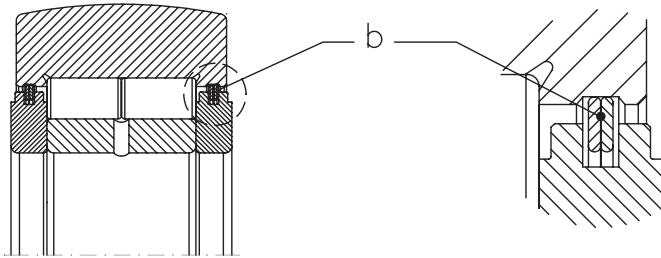

NUTR (b)

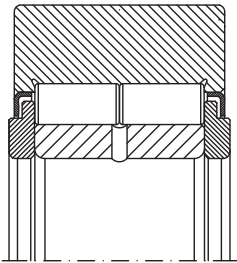

NUTR...X

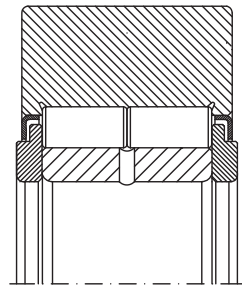

NUTR...XXXX



This causes deformations of the outer ring. These are considered by the recommended maximum values for the permissible dynamic and static loads as given by the product tables.

**Equivalent dynamic load**

Where support rollers must be calculated as rolling element bearings:

$$P = F_r$$

But, **P** must be  $\leq F_{r,max}$   
(for **F<sub>r,max</sub>** see product tables)

**Equivalent static bearing load**

For Support rollers:

$$P_0 = F_r$$

But, **P<sub>0</sub>** must be  $\leq F_{0r,max}$   
(for **F<sub>0r,max</sub>** see product tables)

**Hardened guide surfaces**, however, feature a higher wear – resistance and may therefore be smaller in diameter.

The diameter of the supposed shaft raceway should have a diameter tolerance according to k5.

The shaft or pin, have to fulfill certain requirements in terms of hardness, dimensional and geometric accuracy.

For detailed information on the design requirements see the chapter “Bearing applications” on page 43.

For support roller which are exposed to high axial loads, effective lateral support of their side washers is necessary.

Since Support rollers usually have point loaded inner rings, their shaft may be rather loose (i.e. according to ISO – tolerance fields **g6, h6 or j6**).

**Abutment and Fillet dimensions for Support rollers**

The bearing inner ring must contact adjacent surfaces with their side faces only. The fillet radius of inner ring corners must not touch the fillet radius of shaft shoulder.

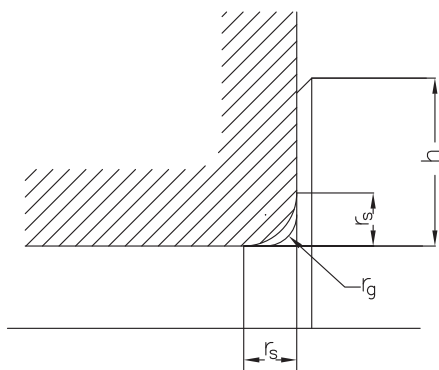

r <sub>smin</sub>	r <sub>gmax</sub>	h <sub>min</sub>
0.6	0.6	2.1
1	1	2.8
1.1	1	3.5
1.5	1.5	4.5
2	2	5.5

# URB





### Support Rollers with axial guidance

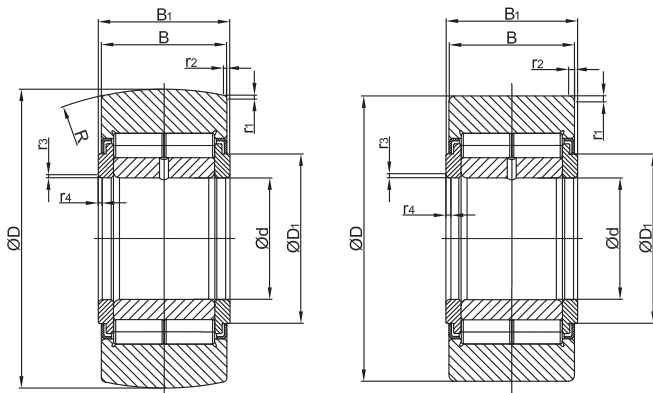

Dimensions							Designation	
D	d	B	B <sub>1</sub>	r <sub>1</sub> , r <sub>2</sub> min.	r <sub>3</sub> , r <sub>4</sub> min.	R	with sphered outer ring	with cylindrical outer ring
mm								
35	15	18	19	0,6	0,3	500	NUTR15	NUTR15 X
40	17	20	21	1	0,3	500	NUTR17	NUTR17 X
42	15	18	19	0,6	0,3	500	NUTR1542	NUTR1542 X
47	17	20	21	1	0,3	500	NUTR1747	NUTR1747 X
47	20	24	25	1	0,3	500	NUTR20	NUTR20 X
52	20	24	25	1	0,3	500	NUTR2052	NUTR2052 X
52	25	24	25	1	0,3	500	NUTR25	NUTR25 X
62	25	24	25	1	0,3	500	NUTR 2562	NUTR2562 X
62	30	28	29	1	0,3	500	NUTR 30	NUTR30 X
72	30	28	29	1	0,3	500	NUTR3072	NUTR3072 X
72	35	28	29	1,1	0,3	500	NUTR35	NUTR35 X
80	35	28	29	1,1	0,6	500	NUTR3580	NUTR3580 X
80	40	30	32	1,1	0,6	500	NUTR40	NUTR40 X
85	45	30	32	1,1	0,6	500	NUTR45	NUTR45 X
90	40	30	32	1,1	0,6	500	NUTR4090	NUTR4090 X
90	50	30	32	1,1	0,6	500	NUTR50	NUTR50 X
100	45	30	32	1,1	0,6	500	NUTR45100	NUTR45100 X
110	50	30	32	1,1	0,6	500	NUTR50110	NUTR50110 X
160	65	70	72	2	2	500	NUTR65x160x72	NUTR65x160x72 X
160	80	70	72	2	2	500	NUTR80x160x72	NUTR80x160x72 X

## Support Rollers with axial guidance

Dimensions		Speed rating	Load ratings				Max.permissible radial load		Mass
D	D <sub>1</sub>		as bearing		as support roller		load		
			dyn. C <sub>r</sub>	stat. C <sub>0r</sub>	dyn. C <sub>LR</sub>	stat. C <sub>OLR</sub>	dyn. F <sub>r max</sub>	stat. F <sub>0r max</sub>	
mm		min <sup>-1</sup>	kN				kN		kg
<b>35</b>	20	5600	24,2	28,5	16,8	17,6	8,7	12,2	0,10
<b>40</b>	22	5300	26	32	19	20	14	22,2	0,15
<b>42</b>	20	5600	24,2	28,5	20,1	17,6	21,6	31	0,16
<b>47</b>	22	5300	26	32	22	27	30	43	0,22
<b>47</b>	28,2	4500	39	49	28,6	33,5	17	25	0,25
<b>52</b>	28,2	4500	39	49	30	39	30	42,5	0,32
<b>52</b>	33,9	3800	44,6	61	29,7	36	18	25,5	0,28
<b>62</b>	33,9	3800	44,6	61	35,8	48	44	63	0,45
<b>62</b>	39,6	3200	60	78	41,3	47,5	24	34,5	0,47
<b>72</b>	39,6	3200	60	78	46,5	61	52	76,5	0,71
<b>72</b>	47,3	2800	65,5	91,5	44	57	33,5	47,5	0,63
<b>80</b>	47,3	2800	65,5	91,5	49	68	57	81,5	0,86
<b>80</b>	55,3	2400	91,3	134	57,2	72	32	45,5	0,82
<b>85</b>	55	2000	98,8	146	58,3	75	32,5	46,5	0,88
<b>90</b>	51	2400	91,3	134	68,2	91,5	63	90	1,16
<b>90</b>	60	1900	101	160	58,3	78	32,5	47,5	0,95
<b>100</b>	55	2000	96,8	146	73,6	104	80	114	1,43
<b>110</b>	60	1900	101	160	78,1	116	98	140	1,73
<b>160</b>	87,3	1600	301	454,6	270	385	390	280	8,8
<b>160</b>	101,8	1500	338	551	295	460	320	425	8,03





# Rolling Elements

## General

Rolling Elements are simple geometric bodies that are produced to very high precision standard by the rolling bearing industry. Rolling elements are made from hardened bearing steel.

They have fine ground or even super finished surfaces as standard. Rolling elements such as Cylindrical Rollers are used in a wide variety of Rolling Bearings for a whole spectrum of applications and industries. Additional to the use in rolling bearings, individual rolling elements are frequently used separately or loose for other requirements or applications, such as Gauge Rollers, Cycles wheels etc.

The more popular sizes are normally available and supplied loose from stock.

## Cylindrical Rollers

### Standards, Boundary dimensions

Cylindrical rollers of through - hardening  
Rolling bearings steel DIN 5402/part 1

### Hardness

**URB** cylindrical rollers made from through - hardened rolling bearing steel according to DIN 17 230 have a surface hardness of **58** up to **65 HRC**.

### Design features

**URB cylindrical rollers** are produced using the latest technology, with the modified surface profile (i.e. semi-crowned) as standard (see sketch below).

This modified profile features a cylindrical center diameter (**A**) that blends into a slightly curved area (**B**) which blends into the roller radii (**r**) and end face.

This feature reduces considerably the negative effect of edge loading and, therefore, additional

stresses. For manufacturing reasons, small cylindrical rollers may have shallow recesses in their end faces. Such recesses have a depth of approximately 0.5 mm the diameter is approximately half the nominal roller diameter (**DW**). **In cases where such recess cylindrical rollers are unsuitable for application reasons, it must be clearly stated on the order.**

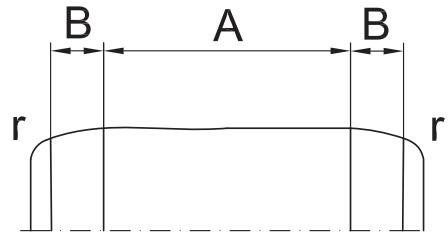



## Tolerances for URB Cylindrical Rollers

Values of dimensional and geometrical accuracy of **URB** cylindrical rollers

Roller diameter Nominal $\varnothing D_w$		Tolerances		Gauge interval I	Gauge mean values (deviation range)			Roundness tolerance to DIN ISO 1101
>	≤	min.	max.					
mm		μm		μm	μm			μm
-	26	-17	11	2	-8 ... -1	0	+1 ... +6	1
26	40	-19,5	+10,5	3	-9 ... -1,5	0	+1,5 ... +6	1,2

Roller Length Nominal $L_w$		Tolerances		Gauge interval I	Gauge mean values (deviation range)			Tolerance of end face runout to DIN ISO 1101
>	≤	min.	max.					
mm		μm		μm	μm			μm
-	48	-20	+10	6	-18 / -12 / -6 / 0 / +6			6
48	-	-45	+15	10	-30 / -20 / -10 / 0 / +10			10

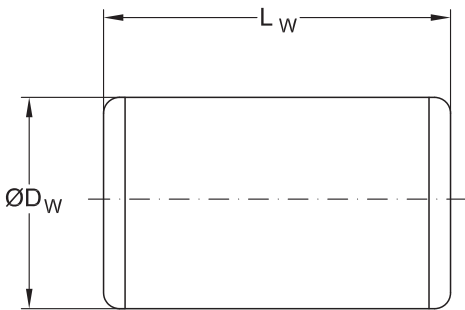

a

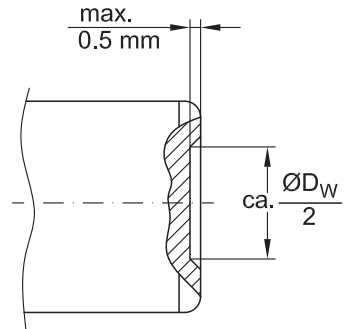

b

### Grades, Tolerances

**URB cylindrical rollers** are graded according to the mean deviations from nominal diameter and length. The lots of rollers are separately packed and the lot designation is marked on the package.

### Designation

The designation consists of the letters "RC", followed by the nominal diameter and nominal length and grade symbol.

Example for designation: RC 6,5x9

**RC** Symbol for cylindrical rollers  
 $D_w = 6,5$ mm (nominal roller diameter)  
 $L_w = 9$ mm (nominal roller length)

### Cylindrical Rollers to other Tolerances

**URB** also produces cylindrical rollers with reduced tolerances to customer order requirements. **URB** will provide detailed information on request.

## Cylindrical Rollers

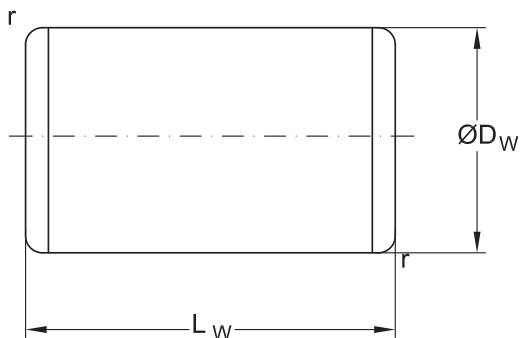

Dimensions				Designation	Mass
$D_w$	$L_w$	$r_{\min}$	$r_{\max}$		
mm					Kg
5	8	0,2	0,5	<b>RC 5X8</b>	0,001
	9	0,2	0,5	<b>RC 5X9</b>	0,001
5,5	5,5	0,2	0,5	<b>RC 5,5X5,5</b>	0,001
	6	0,2	0,5	<b>RC 5,5X6</b>	0,001
6	12	0,3	0,8	<b>RC 6X12</b>	0,003
	22	0,3	0,8	<b>RC 6X22</b>	0,005
	6	0,3	0,8	<b>RC 6X6</b>	0,001
	7	0,3	0,8	<b>RC 6X7</b>	0,002
	8	0,3	0,8	<b>RC 6X8</b>	0,002
	9	0,3	0,8	<b>RC 6X9</b>	0,002
6,5	6,5	0,3	0,8	<b>RC 6,5X6,5</b>	0,002
	7	0,3	0,8	<b>RC 6,5X7</b>	0,002
	8	0,3	0,8	<b>RC 6,5X8</b>	0,002
	9	0,3	0,8	<b>RC 6,5X9</b>	0,002
	10	0,3	0,8	<b>RC 6,5X10</b>	0,003
7	7	0,3	0,8	<b>RC 7X7</b>	0,002
	8	0,3	0,8	<b>RC 7X8</b>	0,002
	10	0,3	0,8	<b>RC 7X10</b>	0,003
	11	0,3	0,8	<b>RC 7X11</b>	0,004
	15	0,3	0,8	<b>RC 7X15</b>	0,005
	17,5	0,3	0,8	<b>RC 7X17,5</b>	0,005
	22	0,3	0,8	<b>RC 7X22</b>	0,006
<b>7,07</b>	35	0,3	0,8	<b>RC 7,07X35</b>	0,011
<b>7,45</b>	11	0,3	0,8	<b>RC 7,45X11</b>	0,004
7,5	7,5	0,3	0,8	<b>RC 7,5X7,5</b>	0,003
	9	0,3	0,8	<b>RC 7,5X9</b>	0,003
	11	0,3	0,8	<b>RC 7,5X11</b>	0,004



### Cylindrical Rollers

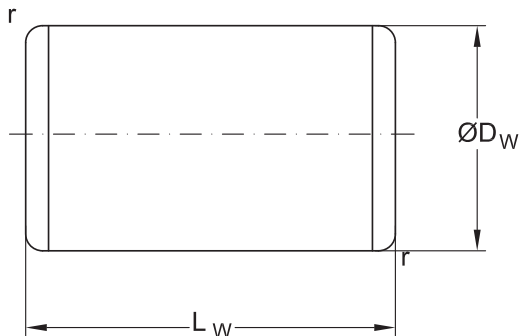

Dimensions				Designation	Mass
$D_w$	$L_w$	$r_{min}$	$r_{max}$		
mm					Kg
7,5	12	0,3	0,8	RC 7,5X12	0,004
	40	0,3	0,8	RC 7,5X40	0,014
7,6	17	0,3	0,8	RC 7,64X17	0,006
7,9	25,4	0,3	0,8	RC 7,9X25,4	0,009
8	6,5	0,3	0,8	RC 8X6,5	0,003
	7	0,3	0,8	RC 8X7	0,003
	7,85	0,3	0,8	RC 8X7,85	0,003
	8	0,3	0,8	RC 8X8	0,003
	10	0,3	0,8	RC 8X10	0,004
	11	0,3	0,8	RC 8X11	0,004
	12	0,3	0,8	RC 8X12	0,005
	14	0,3	0,8	RC 8X14	0,006
	14,5	0,3	0,8	RC 8X14,5	0,006
	16	0,3	0,8	RC 8X16	0,006
	18	0,3	0,8	RC 8X18	0,007
	20	0,3	0,8	RC 8X20	0,008
	26	0,3	0,8	RC 8X26	0,01
28	0,3	0,8	RC 8x28	0,011	
9	9	0,3	0,8	RC 9X9	0,005
	10	0,3	0,8	RC 9X10	0,005
	10,5	0,3	0,8	RC 9X10,5	0,005
	13	0,3	0,8	RC 9X13	0,006
	14	0,3	0,8	RC 9X14	0,0068
	18	0,3	0,8	RC 9X18	0,008
9,5	43	0,3	0,8	RC 9X43	0,021
	6	0,3	0,8	RC 9,5X6	0,003
	8	0,3	0,8	RC 9,5X8	0,0044

## Cylindrical Rollers

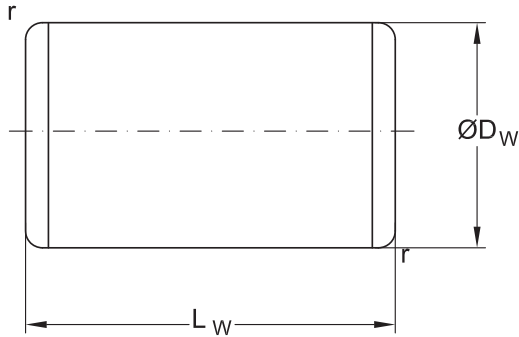

Dimensions				Designation	Mass
$D_w$	$L_w$	$r_{\min}$	$r_{\max}$		
mm					Kg
<b>9,5</b>	9,5	0,3	0,8	<b>RC 9,5X9,5</b>	0,005
<b>10</b>	10	0,5	1,2	<b>RC 10X10</b>	0,006
	11	0,5	1,2	<b>RC 10X11</b>	0,007
	12,5	0,5	1,2	<b>RC 10X12,5</b>	0,008
	14	0,5	1,2	<b>RC 10X14</b>	0,009
	15	0,5	1,2	<b>RC 10X15</b>	0,009
	16	0,5	1,2	<b>RC 10X16</b>	0,01
	17	0,5	1,2	<b>RC 10X17</b>	0,01
	20	0,5	1,2	<b>RC 10X20</b>	0,012
	21,8	0,5	1,2	<b>RC 10X21,8</b>	0,013
<b>10,5</b>	45	0,5	1,2	<b>RC 10X45</b>	0,027
	50	0,5	1,2	<b>RC 10X50</b>	0,031
<b>10,5</b>	21,8	0,5	1,2	<b>RC 10,5X21,8</b>	0,015
<b>10,6</b>	12,5	0,5	1,2	<b>RC 10,6X12,5</b>	0,0084
<b>11</b>	11	0,5	1,2	<b>RC 11X11</b>	0,008
	12	0,5	1,2	<b>RC 11X12</b>	0,009
	13	0,5	1,2	<b>RC 11X13</b>	0,009
	15	0,5	1,2	<b>RC 11X15</b>	0,011
	16	0,5	1,2	<b>RC 11X16</b>	0,012
	18	0,5	1,2	<b>RC 11X18</b>	0,013
	19	0,5	1,2	<b>RC 11X19</b>	0,014
	22	0,5	1,2	<b>RC 11X22</b>	0,016
	30	0,5	1,2	<b>RC 11X30</b>	0,022
	43.637	0,5	1,2	<b>RC 11X43,637</b>	0,033
<b>11.112</b>	47,5	0,5	1,2	<b>RC 11,1125X47,5</b>	0,036
<b>11.684</b>	64,77	0,5	1,2	<b>RC 11,684X64,77</b>	0,055
<b>12</b>	12	0,5	1,2	<b>RC 12X12</b>	0,01



### Cylindrical Rollers

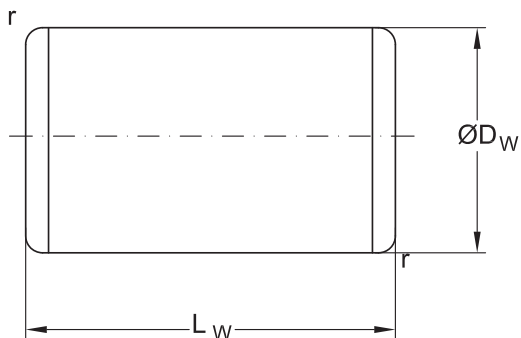

Dimensions				Designation	Mass
$D_w$	$L_w$	$r_{min}$	$r_{max}$		
mm					Kg
12	13,5	0,5	1,2	RC 12X13,5	0,012
	14	0,5	1,2	RC 12X14	0,012
	17	0,5	1,2	RC 12X17	0,015
	18	0,5	1,2	RC 12X18	0,016
	21	0,5	1,2	RC 12X21	0,018
	47,5	0,5	1,2	RC 12X47,5	0,042
	58	0,5	1,2	RC 12X58	0,051
12,7	12,7	0,5	1,2	RC 12,7X12,7	0,013
	22,2	0,5	1,2	RC 12,7X22,2	0,022
	31,75	0,5	1,2	RC 12,7X31,75	0,032
	50,8	0,5	1,2	RC 12,7X50,8	0,05
	55,5	0,5	1,2	RC 12,7X55,5	0,055
	64,135	0,5	1,2	RC 12,7X64,135	0,063
	76,2	0,5	1,2	RC 12,7X76,2	0,077
13	13	0,5	1,2	RC 13X13	0,013
	14	0,5	1,2	RC 13X14	0,014
	14,5	0,5	1,2	RC 13X14,5	0,014
	18	0,5	1,2	RC 13X18	0,018
	20	0,5	1,2	RC 13X20	0,02
	21	0,5	1,2	RC 13X21	0,022
	25	0,5	1,2	RC 13X25	0,026
	26	0,5	1,2	RC 13X26	0,027
14	13	0,5	1,2	RC 14X13	0,016
	14	0,5	1,2	RC 14X14	0,017
	15	0,5	1,2	RC 14X15	0,018
	18	0,5	1,2	RC 14X18	0,022
	19	0,5	1,2	RC 14X19	0,023

## Cylindrical Rollers

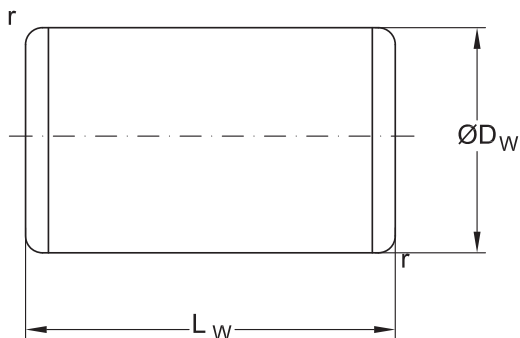

Dimensions				Designation	Mass
$D_w$	$L_w$	$r_{min}$	$r_{max}$		
mm					Kg
<b>14</b>	20	0,5	1,2	<b>RC 14X20</b>	0,024
	21	0,5	1,2	<b>RC 14X21</b>	0,025
	22	0,5	1,2	<b>RC 14X22</b>	0,026
	26	0,5	1,2	<b>RC 14X26</b>	0,031
	28	0,5	1,2	<b>RC 14X28</b>	0,033
	55	0,5	1,2	<b>RC 14X55</b>	0,066
<b>14.287</b>	79.375	0,5	1,2	<b>RC 14,2875X79,375</b>	0,099
<b>14.376</b>	63,5	0,5	1,2	<b>RC 14,376X63,5</b>	0,08
<b>14.478</b>	49.835	0,5	1,2	<b>RC 14,478X49,835</b>	0,064
<b>14,5</b>	30	0,5	1,2	<b>RC 14,5X30</b>	0,039
<b>15</b>	15	0,5	1,2	<b>RC 15X15</b>	0,02
	16	0,5	1,2	<b>RC 15X16</b>	0,022
	17	0,5	1,2	<b>RC 15X17</b>	0,023
	22	0,5	1,2	<b>RC 15X22</b>	0,03
	24	0,5	1,2	<b>RC 15X24</b>	0,033
	26	0,5	1,2	<b>RC 15X26</b>	0,036
	28	0,5	1,2	<b>RC 15X28</b>	0,039
	30	0,5	1,2	<b>RC 15X30</b>	0,041
	32	0,5	1,2	<b>RC 15X32</b>	0,042
<b>15,8</b>	17	0,5	1,2	<b>RC802876</b>	0,025
<b>15.875</b>	100	0,5	1,2	<b>RC 15,875X100</b>	0,155
	15.875	0,5	1,2	<b>RC 15,875X15,875</b>	0,024
	22.225	0,5	1,2	<b>RC 15,875X22,225</b>	0,03
	57,15	0,5	1,2	<b>RC 15,875X57,15</b>	0,088
	88,9	0,5	1,2	<b>RC 15,875X88,9</b>	0,138
	92,07	0,5	1,2	<b>RC 15,875X92,075</b>	0,143
<b>16</b>	16	0,7	1,5	<b>RC 16X16</b>	0,025



### Cylindrical Rollers

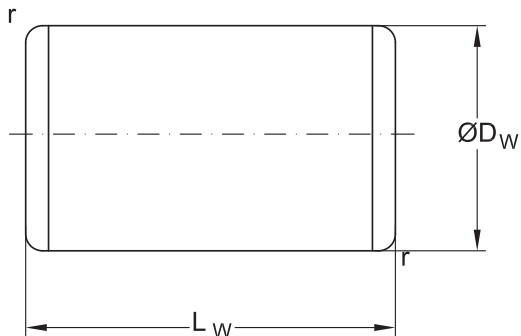

Dimensions				Designation	Mass
$D_w$	$L_w$	$r_{\min}$	$r_{\max}$		
mm					Kg
<b>16</b>	17	0,7	1,5	<b>RC 16X17</b>	0,027
	22	0,7	1,5	<b>RC 16X22</b>	0,034
	24	0,7	1,5	<b>RC 16X24</b>	0,037
	25	0,7	1,5	<b>RC 16X25</b>	0,038
	26	0,7	1,5	<b>RC 16X26</b>	0,041
	27	0,7	1,5	<b>RC 16X27</b>	0,042
	40	0,7	1,5	<b>RC 16X40 II</b>	0,063
<b>16.002</b>	63,5	0,7	1,5	<b>RC 16,002X63,5</b>	0,099
<b>16.015</b>	34,78	0,7	1,5	<b>RC 16,015X34,78</b>	0,055
<b>16,5</b>	24	0,7	1,5	<b>RC 16,5X24</b>	0,04
<b>17</b>	15,5	0,7	1,5	<b>RC 17x15,5</b>	0,027
	17	0,7	1,5	<b>RC 17X17</b>	0,03
	24	0,7	1,5	<b>RC 17X24</b>	0,042
	34	0,7	1,5	<b>RC 17X34</b>	0,06
	44	0,7	1,5	<b>RC 17X44</b>	0,078
<b>17,3</b>	38	0,7	1,5	<b>RC 17,3X38</b>	0,07
<b>17,36</b>	34,93	0,7	1,5	<b>RC 17,36X34,93</b>	0,065
<b>18</b>	18	0,7	1,5	<b>RC 18X18</b>	0,036
	19	0,7	1,5	<b>RC 18X19</b>	0,038
	26	0,7	1,5	<b>RC 18X26</b>	0,052
	30	0,7	1,5	<b>RC 18X30</b>	0,06
	32	0,7	1,5	<b>RC 18X32</b>	0,064
	36	0,7	1,5	<b>RC 18X36</b>	0,072
<b>18,04</b>	41,28	0,7	1,5	<b>RC 18,04X41,28</b>	0,082
<b>18,3</b>	114,3	0,7	1,5	<b>RC 18,3X114,3</b>	0,234
	21	0,7	1,5	<b>RC949453</b>	0,042
<b>18,8</b>	22,3	0,7	1,5	<b>RC 18,8X22,3</b>	0,047



## Cylindrical Rollers

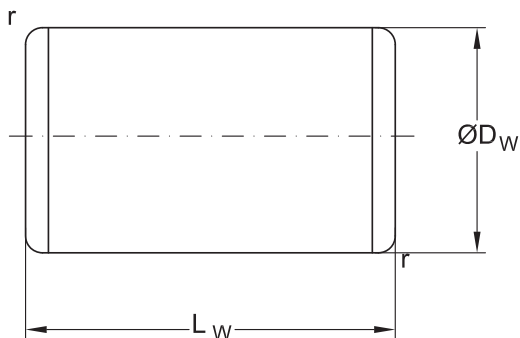

Dimensions				Designation	Mass
$D_w$	$L_w$	$r_{min}$	$r_{max}$		
mm					Kg
<b>18,85</b>	41,2	0,7	1,5	<b>RC 18,85X41,2</b>	0,09
<b>19</b>	19	0,7	1,5	<b>RC 19X19</b>	0,042
	20	0,7	1,5	<b>RC 19X20</b>	0,044
	22	0,7	1,5	<b>RC 19X22</b>	0,048
	26	0,7	1,5	<b>RC 19X26</b>	0,058
	27	0,7	1,5	<b>RC 19X27</b>	0,06
	28	0,7	1,5	<b>RC 19X28</b>	0,061
	30	0,7	1,5	<b>RC 19X30</b>	0,066
	32	0,7	1,5	<b>RC 19X32</b>	0,07
	38	0,7	1,5	<b>RC 19X38</b>	0,084
<b>19,05</b>	39	0,7	1,5	<b>RC 19X39</b>	0,086
	12,7	0,7	1,5	<b>RC 19,05X12,7</b>	0,028
	17,45	0,7	1,5	<b>RC 19,05X17,45</b>	0,039
	19,304	0,7	1,5	<b>RC 19,05X19,304</b>	0,043
	20,625	0,7	1,5	<b>RC 19,05X20,625</b>	0,046
	22,22	0,7	1,5	<b>RC 19,05X22,22</b>	0,05
	23,8	0,7	1,5	<b>RC 19,05X23,8</b>	0,053
	25,4	0,7	1,5	<b>RC 19,05X25,4</b>	0,057
	28,57	0,7	1,5	<b>RC 19,05X28,57</b>	0,064
76,2	0,7	1,5	<b>RC 19,05X76,2</b>	0,17	
<b>19,5</b>	21	0,7	1,5	<b>RC 19,5X21</b>	0,049
<b>20</b>	20	0,7	1,5	<b>RC 20X20</b>	0,049
	24	0,7	1,5	<b>RC 20X24</b>	0,06
	26	0,7	1,5	<b>RC 20X26</b>	0,064
	30	0,7	1,5	<b>RC 20X30</b>	0,073
	35	0,7	1,5	<b>RC 20X35</b>	0,086
	38	0,7	1,5	<b>RC 20X38</b>	0,093



### Cylindrical Rollers

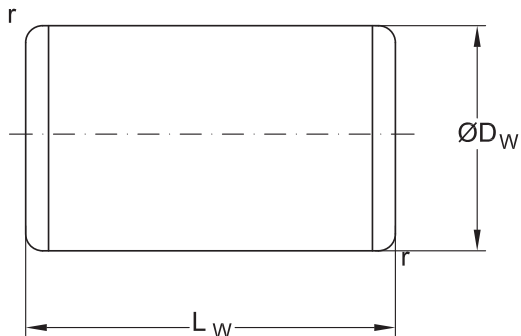

Dimensions				Designation	Mass
$D_w$	$L_w$	$r_{min}$	$r_{max}$		
mm					Kg
20	40	0,7	1,5	RC 20X40	0,098
	41	0,7	1,5	RC 20X41	0,1
	44,45	0,7	1,5	RC 20X44,45	0,109
	50	0,7	1,5	RC 20X50	0,123
21	21	0,7	1,5	RC 21X21	0,056
	22	0,7	1,5	RC 21X22	0,059
	23	0,7	1,5	RC 21X23	0,062
	26	0,7	1,5	RC 21X26	0,071
	30	0,7	1,5	RC 21X30	0,08
	32	0,7	1,5	RC 21X32	0,086
	34	0,7	1,5	RC 21X34	0,092
21,5	38	0,7	1,5	RC 21,5X38	0,108
21,59	50,8	0,7	1,5	RC 21,59X50,8	0,146
22	22	0,7	1,5	RC 22X22	0,064
	22,3	0,7	1,5	RC 22X22,3	0,066
	24	0,7	1,5	RC 22X24	0,071
	32	0,7	1,5	RC 22X32	0,095
	34	0,7	1,5	RC 22X34	0,1
	44	0,7	1,5	RC 22X44	0,108
	50	0,7	1,5	RC 22X50	0,149
	71	0,7	1,5	RC 22X71	0,212
90	0,7	1,5	RC 22X90	0,268	
22,22	11,18	0,7	1,5	RC 22,22X11,18	0,034
	13,97	0,7	1,5	RC 22,22X13,97	0,042
	15,87	0,7	1,5	RC 22,22X15,87	0,048
	19,05	0,7	1,5	RC 22,22X19,05	0,058
	22,22	0,7	1,5	RC 22,22X22,22	0,067

## Cylindrical Rollers

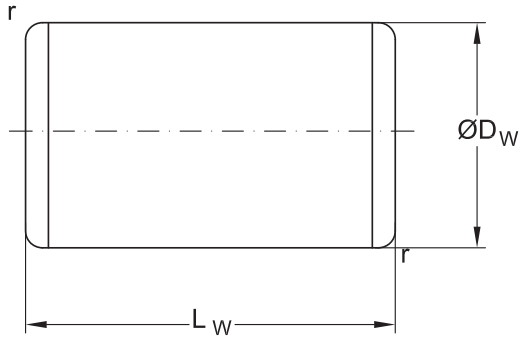

Dimensions				Designation	Mass
$D_w$	$L_w$	$r_{min}$	$r_{max}$		
mm					Kg
<b>22.225</b>	37.593	0,7	1,5	<b>RC 22,225X37,593</b>	0,114
	50,8	0,7	1,5	<b>RC 22,225X50,8</b>	0,154
<b>22,45</b>	57	0,7	1,5	<b>RC 22,45X57</b>	0,117
<b>22,5</b>	40	0,7	1,5	<b>RC 22,5X40</b>	0,124
<b>23</b>	23	0,7	1,5	<b>RC 23X23</b>	0,074
	24	0,7	1,5	<b>RC 23X24</b>	0,078
	32	0,7	1,5	<b>RC 23X32</b>	0,104
	34	0,7	1,5	<b>RC 23X34</b>	0,112
	48	0,7	1,5	<b>RC 23X48</b>	0,155
<b>23,7</b>	29,5	0,7	1,5	<b>RC825160</b>	0,1
<b>23,78</b>	64.325	0,7	1,5	<b>RC 23,78X64,325</b>	0,224
<b>23,8</b>	25,4	0,7	1,5	<b>RC 23,81X25,4</b>	0,088
<b>24</b>	24	1,1	2,1	<b>RC 24X24</b>	0,084
	26	1,1	2,1	<b>RC 24X26</b>	0,092
	34	1,1	2,1	<b>RC 24X34</b>	0,12
	36	1,1	2,1	<b>RC 24X36</b>	0,126
	36,5	1,1	2,1	<b>RC 24X36,5</b>	0,129
	38	1,1	2,1	<b>RC 24X38</b>	0,134
	48	1,1	2,1	<b>RC 24X48</b>	0,175
	52	1,1	2,1	<b>RC 24X52</b>	0,18
	56	1,1	2,1	<b>RC 24X56</b>	0,196
<b>25</b>	25	1,1	2,1	<b>RC 25X25</b>	0,095
	27	1,1	2,1	<b>RC 25X27</b>	0,103
	32	1,1	2,1	<b>RC 25X32</b>	0,123
	35	1,1	2,1	<b>RC 25x35</b>	0,133
	36	1,1	2,1	<b>RC 25X36</b>	0,137
	40	1,1	2,1	<b>RC 25X40</b>	0,154



### Cylindrical Rollers

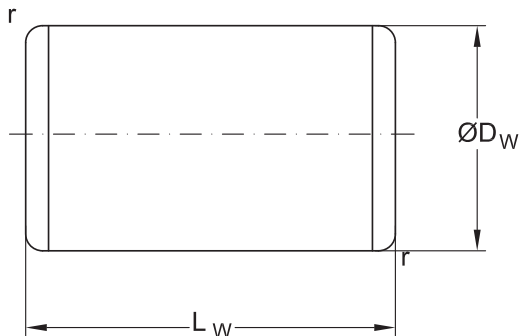

Dimensions				Designation	Mass
$D_w$	$L_w$	$r_{min}$	$r_{max}$		
mm					Kg
<b>25</b>	50	1,1	2,1	<b>RC 25X50</b>	0,16
<b>25,4</b>	25,4	1,1	2,1	<b>RC 25,4X25,4</b>	0,1
	27,5	1,1	2,1	<b>RC 25,4X27,5</b>	0,109
	28,58	1,1	2,1	<b>RC 25,4X28,58</b>	0,113
	38,1	1,1	2,1	<b>RC 25,4X38,1</b>	0,15
	50,8	1,1	2,1	<b>RC 25,4X50,8</b>	0,202
	57,15	1,1	2,1	<b>RC 25,4X57,15</b>	0,227
	76,2	1,1	2,1	<b>RC 25,4X76,2</b>	0,303
<b>25,5</b>	38,5	1,1	2,1	<b>RC 25,5X38,5</b>	0,154
<b>25,8</b>	25,8	1,1	2,1	<b>RC 25,8X25,8</b>	0,106
	60	1,1	2,1	<b>RC 25,8X60</b>	0,246
<b>25,93</b>	25,4	1,1	2,1	<b>RC 25,93X25,4</b>	0,105
<b>25,98</b>	54,76	1,1	2,1	<b>RC 25,98X54,76</b>	0,228
<b>26</b>	26	1,1	2,1	<b>RC 26X26</b>	0,107
	28	1,1	2,1	<b>RC 26X28</b>	0,116
	30	1,1	2,1	<b>RC 26X30</b>	0,124
	40	1,1	2,1	<b>RC 26X40</b>	0,164
	45	1,1	2,1	<b>RC 26X45</b>	0,187
	55	1,1	2,1	<b>RC 26X55</b>	0,226
	61	1,1	2,1	<b>RC 26X61</b>	0,254
	78	1,1	2,1	<b>RC 26X78</b>	0,326
<b>27</b>	26,5	1,1	2,1	<b>RC 27X26,5</b>	0,119
	46	1,1	2,1	<b>RC 27X46</b>	0,205
	48	1,1	2,1	<b>RC 27X48</b>	0,204
	50	1,1	2,1	<b>RC 27X50</b>	0,224
<b>27,05</b>	48	1,1	2,1	<b>RC 27,05x48</b>	0,213
<b>28</b>	22	1,1	2,1	<b>RC 28X22</b>	0,104

## Cylindrical Rollers

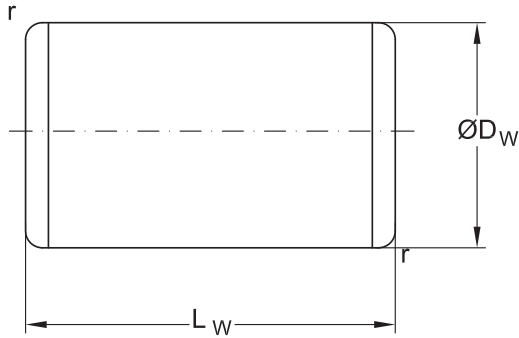

Dimensions				Designation	Mass
$D_w$	$L_w$	$r_{min}$	$r_{max}$		
mm					Kg
28	28	1,1	2,1	<b>RC 28X28</b>	0,133
	30	1,1	2,1	<b>RC 28X30</b>	0,144
	40	1,1	2,1	<b>RC 28X40</b>	0,193
	44	1,1	2,1	<b>RC 28X44</b>	0,21
	50	1,1	2,1	<b>RC 28X50</b>	0,241
	56	1,1	2,1	<b>RC 28X56</b>	0,27
	58	1,1	2,1	<b>RC 28X58</b>	0,28
	70	1,1	2,1	<b>RC 28X70</b>	0,338
<b>28,24</b>	28,57	1,1	2,1	<b>RC 28,24X28,57</b>	0,14
<b>28,5</b>	42	1,1	2,1	<b>RC 28,5X42</b>	0,17
<b>28,57</b>	63,5	1,1	2,1	<b>RC 28,57X63,5</b>	0,319
	69,85	1,1	2,1	<b>RC 28,57X69,85</b>	0,351
<b>28.575</b>	31,75	1,1	2,1	<b>RC 28,575X31,75</b>	0,158
	44,45	1,1	2,1	<b>RC 28,575X44,45</b>	0,223
<b>28,9</b>	69,85	1,1	2,1	<b>RC 28,6X69,85</b>	0,352
29	28,45	1,1	2,1	<b>RC 29X28,45</b>	0,146
	47,5	1,1	2,1	<b>RC 29X47,5</b>	0,246
	47,5	1,1	2,1	<b>RC 29X47,5</b>	0,218
<b>29,4</b>	29,1	1,1	2,1	<b>RC 29,4X29,1</b>	0,156
<b>29,74</b>	69,72	1,1	2,1	<b>RC 29,74X69,72</b>	0,38
30	30	1,1	2,1	<b>RC 30X30</b>	0,163
	33	1,1	2,1	<b>RC 30X33</b>	0,183
	36	1,1	2,1	<b>RC 30X36</b>	0,198
	48	1,1	2,1	<b>RC 30X48</b>	0,262
	52	1,1	2,1	<b>RC 30X52</b>	0,28
	60	1,1	2,1	<b>RC 30X60</b>	0,332
<b>30,05</b>	48	1,1	2,1	<b>RC 30,05x48</b>	0,266



### Cylindrical Rollers

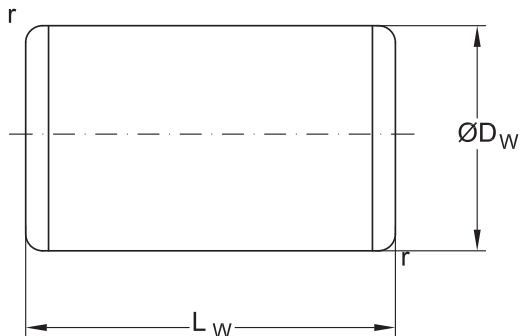

Dimensions				Designation	Mass
$D_w$	$L_w$	$r_{\min}$	$r_{\max}$		
mm					Kg
30,16	34,925	1,1	2,1	<b>RC 30,16X34,925</b>	0,17
	63,5	1,1	2,1	<b>RC 30,16X63,5</b>	0,325
31	68	1,1	2,1	<b>RC 31X68 S1</b>	0,399
	72	1,1	2,1	<b>RC 31X72</b>	0,425
31,75	25,4	1,1	2,1	<b>RC 31,75X25,4</b>	0,157
	31,75	1,1	2,1	<b>RC 31,75X31,75</b>	0,195
	41,275	1,1	2,1	<b>RC 31,75X41,275</b>	0,256
	48	1,1	2,1	<b>RC 31,75X48</b>	0,297
	52,53	1,1	2,1	<b>RC 31,75X52,53</b>	0,326
	53,98	1,1	2,1	<b>RC 31,75X53,98</b>	0,335
32	76,2	1,1	2,1	<b>RC 31,75X76,2</b>	0,473
	32	1,5	2,7	<b>RC 32X32</b>	0,199
	47,6	1,5	2,7	<b>RC 32X47,6</b>	0,298
	48	1,5	2,7	<b>RC 32X48</b>	0,302
	48,5	1,5	2,7	<b>RC 32X48,5</b>	0,306
	50	1,5	2,7	<b>RC 32X50</b>	0,315
	52	1,5	2,7	<b>RC 32X52</b>	0,326
96	1,5	2,7	<b>RC 32X96</b>	0,606	
72	1,5	2,7	<b>RC 32X72</b>	0,543	
<b>32,36</b>	73,38	1,5	2,7	<b>RC 32,26X73,38</b>	0,47
<b>32,5</b>	65	1,5	2,7	<b>RC 32,5X65</b>	0,405
<b>33</b>	50	1,5	2,7	<b>RC 33X50</b>	0,335
<b>33,3</b>	34,925	1,5	2,7	<b>RC 33,3X34,925</b>	0,238
<b>33,35</b>	57	1,5	2,7	<b>RC 33,35X57</b>	0,391
<b>33,6</b>	41	1,5	2,7	<b>RC764075</b>	0,276
34	34	1,5	2,7	<b>RC 34X34</b>	0,239
	55	1,5	2,7	<b>RC 34X55</b>	0,387

## Cylindrical Rollers

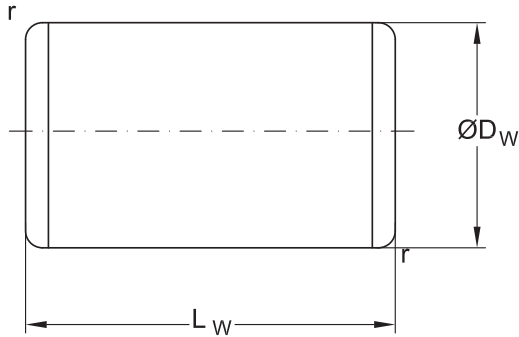

Dimensions				Designation	Mass
$D_w$	$L_w$	$r_{min}$	$r_{max}$		
mm					Kg
<b>34</b>	74	1,5	2,7	<b>RC 34X74</b>	0,526
	76	1,5	2,7	<b>RC 34X76</b>	0,54
<b>34,46</b>	83	1,5	2,7	<b>RC 34,46X83</b>	0,607
<b>35</b>	143	1,5	2,7	<b>RC 35X143</b>	1
	33,5	1,5	2,7	<b>RC 35X33,5</b>	0,252
	46	1,5	2,7	<b>RC 35X46</b>	0,345
	70	1,5	2,7	<b>RC 35X70</b>	0,528
<b>36</b>	36	1,5	2,7	<b>RC 36X36</b>	0,283
	58	1,5	2,7	<b>RC 36X58</b>	0,457
	72	1,5	2,7	<b>RC 36X72</b>	0,575
	74	1,5	2,7	<b>RC 36X74</b>	0,583
<b>37</b>	82	1,5	2,7	<b>RC 37X82</b>	0,69
<b>37,5</b>	125	1,5	2,7	<b>RC 37,5X125</b>	1,084
	77	1,5	2,7	<b>RC 37,5X77</b>	0,667
	85	1,5	2,7	<b>RC 37,5X85</b>	0,737
<b>38</b>	38	1,5	2,7	<b>RC 38X38</b>	0,333
	41	1,5	2,7	<b>RC 38X41</b>	0,365
	47	1,5	2,7	<b>RC 38X47</b>	0,418
	54	1,5	2,7	<b>RC 38X54</b>	0,48
	55	1,5	2,7	<b>RC 38X55</b>	0,488
	62	1,5	2,7	<b>RC 38X62</b>	0,55
	65	1,5	2,7	<b>RC 38X65</b>	0,57
	80	1,5	2,7	<b>RC 38X80</b>	0,712
	84	1,5	2,7	<b>RC 38X84</b>	0,75
	86	1,5	2,7	<b>RC 38X86</b>	0,764
<b>38,1</b>	44,45	1,5	2,7	<b>RC 38,1X44,45</b>	0,396
<b>38,86</b>	63,5	1,5	2,7	<b>RC 38,86X63,5</b>	0,59



## Cylindrical Rollers

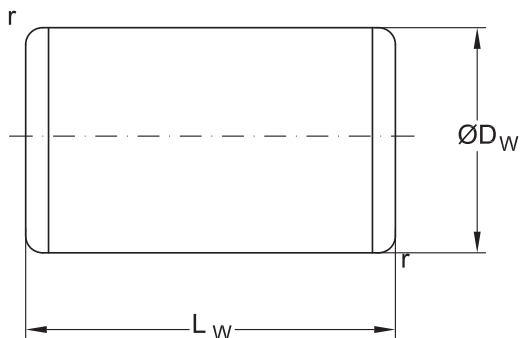

Dimensions				Designation	Mass
D <sub>w</sub>	L <sub>w</sub>	r <sub>min</sub>	r <sub>max</sub>		
mm					Kg
<b>38,86</b>	76	1,5	2,7	<b>RC 38,86X76</b>	0,707
<b>39</b>	59	1,5	2,7	<b>RC 39X59</b>	0,552
<b>40</b>	40	1,5	2,7	<b>RC 40X40</b>	0,389
	43	1,5	2,7	<b>RC 40X43</b>	0,42
	65	1,5	2,7	<b>RC 40X65</b>	0,63
	70	1,5	2,7	<b>RC 40X70</b>	0,688
	85	1,5	2,7	<b>RC 40X85</b>	0,837
<b>40,6</b>	42,6	1,5	2,7	<b>RC 40,6X42,6</b>	0,425
<b>41</b>	78	1,5	2,7	<b>RC 41X78</b>	0,807
<b>42</b>	42	1,5	2,7	<b>RC 42X42</b>	0,457
	72	1,5	2,7	<b>RC 42X72</b>	0,76
	85	1,5	2,7	<b>RC 42X85</b>	0,923
<b>42,1</b>	65	1,5	2,7	<b>RC 42,1x65</b>	0,708
<b>43,3</b>	90	1,5	2,7	<b>RC 43,3X90</b>	1,039
<b>44,5</b>	66,6	1,5	2,7	<b>RC 44,5X66,6</b>	0,81
<b>45</b>	32	1,5	2,7	<b>RC 45X32</b>	0,399
	45	1,5	2,7	<b>RC 45X45</b>	0,562
	48	1,5	2,7	<b>RC 45X48</b>	0,6
	75	1,5	2,7	<b>RC 45X75</b>	0,936
	90	1,5	2,7	<b>RC 45X90</b>	1,122
<b>45,83</b>	45	1,5	2,7	<b>RC 45,83x45</b>	0,126
<b>48</b>	48	1,5	2,7	<b>RC 48X48</b>	0,682
	72	1,5	2,7	<b>RC 48X72</b>	1,022
	80	1,5	2,7	<b>RC 48X80</b>	1,133
<b>49</b>	85	1,5	2,7	<b>RC 49X85</b>	1,256
	88	1,5	2,7	<b>RC 49X88</b>	1,3
<b>50</b>	108	2,5	4	<b>RC 50X108</b>	1,66



## Cylindrical Rollers

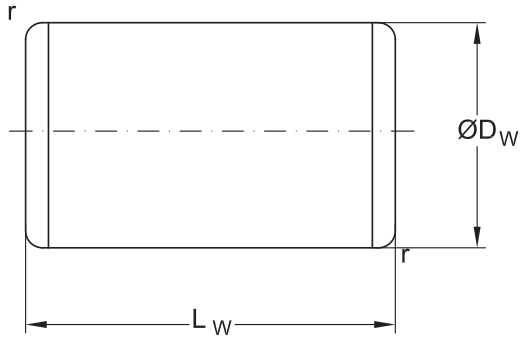

Dimensions				Designation	Mass
$D_w$	$L_w$	$r_{\min}$	$r_{\max}$		
mm					Kg
50	49	2,5	4	RC 50X49	0,753
	50	2,5	4	RC 50X50	0,77
	85	2,5	4	RC 50X85	1,3
50,8	85,725	2,5	4	RC 50,8X85,725	1.362
51	108	2,5	4	RC 51X108	1.732
	36,5	2,5	4	RC 51X36,5	0,582
	42,5	2,5	4	RC 51X42,5	0,681
	49	2,5	4	RC 51X49	0,785
52	52	2,5	4	RC 52X52	0,865
54	54	2,5	4	RC 54X54	0,97
	56	2,5	4	RC 54X56	1.006
	95	2,5	4	RC 54X95	1,7
56	100	2,5	4	RC 56X100	1.909
	56	2,5	4	RC 56X56	1.078
58	90	2,5	4	RC 58X90	1.867
60	100	2,5	4	RC 60X100	2.214
63,45	36	2,5	4	RC 63,45X36	0,888
	42,6	2,5	4	RC 63,45X42,6	1.052
	46	2,5	4	RC 63,45X46	1.136
	48,8	2,5	4	RC 63,45X48,8	1.205
68	105	2,5	4	RC 68X105	2.957
75	120	2,5	4	RC 75X120	4.154
76	110	2,5	4	RC 76X110	3,91
80	125	2,5	4	RC 80X125	4,9

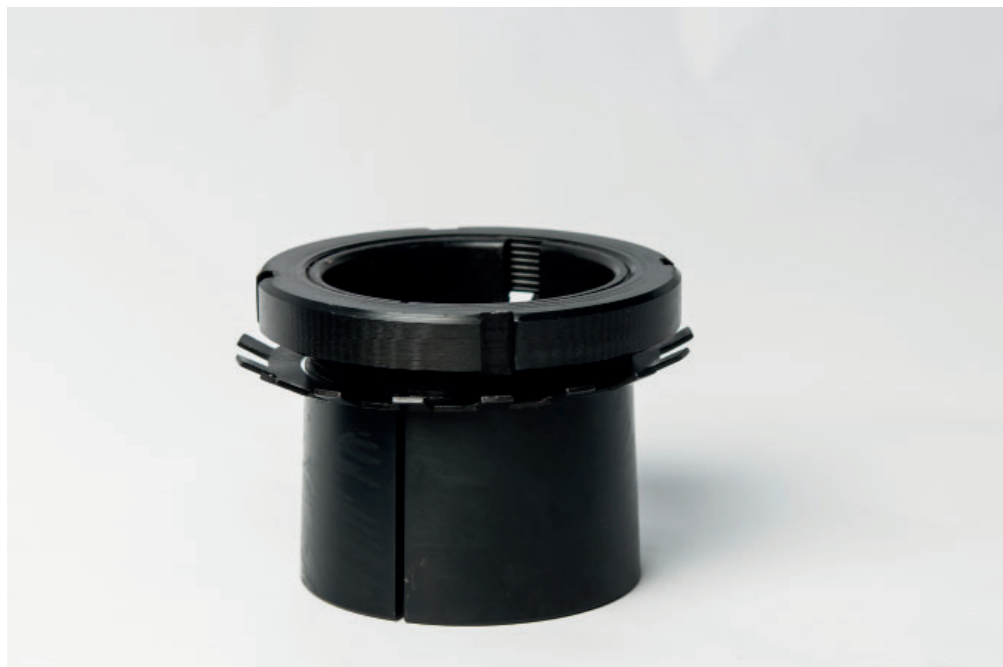

# Adapter and Withdrawal Sleeves

## General

**Adapter and Withdrawal Sleeves** are devices using to mount and secure rolling element bearings with tapered bores onto cylindrical shaft seats.

This enables the mounting or dismounting of rolling element bearings in a simple and effective way to for a variety of applications.

Since, adapter and withdrawal sleeves are able to adapt to shaft diameter variations within certain limits, larger than normal **shaft diameter tolerances** are accomodated.

The **geometrical accuracy**, however, must be more closely defined, as the forms errors of the shaft affect the running accuracy of the total bearing arrangement in a direct way.

Furthermore, using adapter or withdrawal sleeves allows bearing seats with lower surface qualities, (e.g. turned surfaces) to be acceptable. For applications where no accurate shaft guidance of bearings is required, bright drawn round bar stock may also be used.

Generally the following tolerances may be used for guidance:

Expected running accuracy	Diameter tolerance	Form accuracy
Normal	h7, h8, h9	$\frac{IT5}{2}$
Low	h10, h11	$\frac{IT7}{2}$

## Adapter sleeves

### Standards, boundary, dimensions

Adapter Sleeves                      DIN 5415

### General

**Adapter sleeves** (see sketch below) are slotted steel sleeves that have a tapered outer diameter, taper 1:12 on one side and a thread on the opposite side.

Small adapter sleeves may have phosphated surfaces, normally they are only oil preserved.

**URB adapter sleeves** are supplied complete with lock nut and locking washer as standard.

Beside the standard design (see figure **a**), there are also larger adapter sleeves available with oil bores and oil distribution ducs, (prefix **OH**) as required for applying the oil injection method as shown in figure **b**.

On smooth straight shafts, (e.g. on a drawn round stock), adapter sleeves allow a simple positioning of bearings in any position, (see figure c).

In applications where bearings with adapter sleeves are mounted on straight shafts without axial support, (see figure c), their ability to accept axial forces is limited by the friction between the adapter sleeve and the shaft.

In the case of higher axial forces, the bearing needs to be secured additionally by **supporting rings** (see figure **d**).

When designing such supporting rings, however, the abutment dimensions recommended by the product tables must be considered.

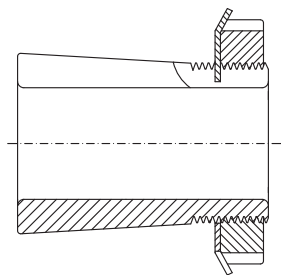

a

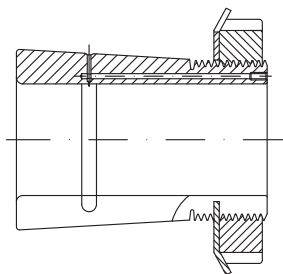

b

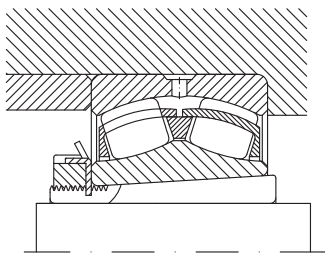

c

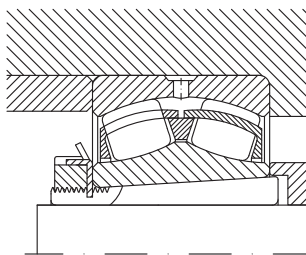

d

# URB





Adapter sleeves

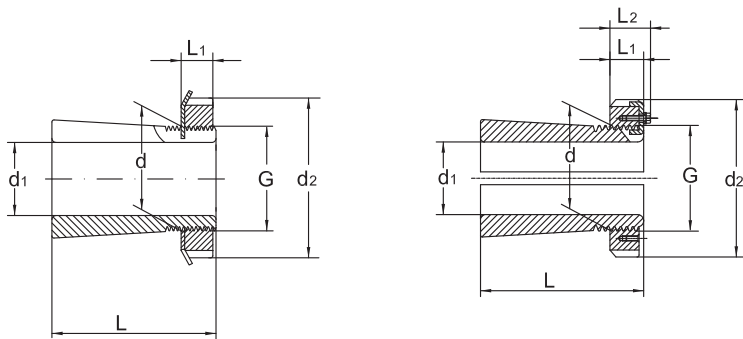

Shaft Ø	Dimension			Designation adapter sleeve, complete	Mass
	d <sub>1</sub>	d	d <sub>2</sub>		
mm					kg
17	20	32	24	<b>H204</b>	0,04
		32	28	<b>H304</b>	0,04
		32	31	<b>H2304</b>	0,05
20	25	38	26	<b>H205</b>	0,06
		38	29	<b>H305</b>	0,07
		38	35	<b>H2305</b>	0,09
25	30	45	27	<b>H206</b>	0,09
		45	31	<b>H306</b>	0,10
		45	38	<b>H2306</b>	0,11
30	35	52	29	<b>H207</b>	0,12
		52	35	<b>H307</b>	0,14
		52	43	<b>H2307</b>	0,15
35	40	58	31	<b>H208</b>	0,16
		58	36	<b>H308</b>	0,18
		58	46	<b>H2308</b>	0,22
40	45	65	33	<b>H209</b>	0,21
		65	39	<b>H309</b>	0,23
		65	50	<b>H2309</b>	0,27
45	50	70	35	<b>H210</b>	0,24
		70	42	<b>H310</b>	0,27
		70	55	<b>H2310</b>	0,34
50	55	75	37	<b>H211</b>	0,28
		75	45	<b>H311</b>	0,32
		75	59	<b>H2311</b>	0,39

## Adapter sleeves

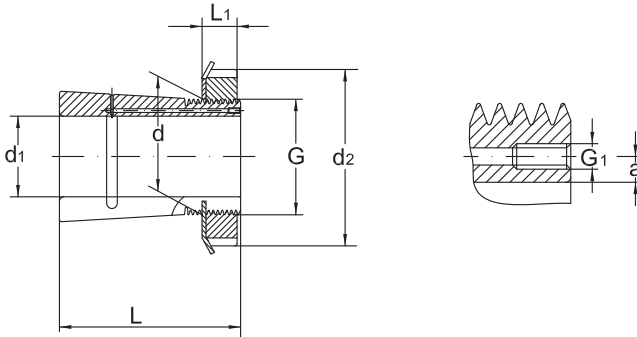

Shaft Ø	Thread	Dimensions				Lock nut	Locking Device
		d <sub>1</sub>	G	L <sub>1</sub>	L <sub>2</sub>		
mm							
17	M 20 X 1	7	-	-	-	KM4	MB4
	M 20 X 1	7	-	-	-	KM4	MB4
	M 20 X 1	7	-	-	-	KM4	MB4
20	M 25 X 1,5	8	-	-	-	KM5	MB5
	M 25 X 1,5	8	-	-	-	KM5	MB5
	M 25 X 1,5	8	-	-	-	KM5	MB5
25	M 30 X 1,5	8	-	-	-	KM6	MB6
	M 30 X 1,5	8	-	-	-	KM6	MB6
	M 30 X 1,5	8	-	-	-	KM6	MB6
30	M 35 X 1,5	9	-	-	-	KM7	MB7
	M 35 X 1,5	9	-	-	-	KM7	MB7
	M 35 X 1,5	9	-	-	-	KM7	MB7
35	M 40 X 1,5	10	-	-	-	KM8	MB8
	M 40 X 1,5	10	-	-	-	KM8	MB8
	M 40 X 1,5	10	-	-	-	KM8	MB8
40	M 45 X 1,5	11	-	-	-	KM9	MB9
	M 45 X 1,5	11	-	-	-	KM9	MB9
	M 45 X 1,5	11	-	-	-	KM9	MB9
45	M 50 X 1,5	12	-	-	-	KM10	MB10
	M 50 X 1,5	12	-	-	-	KM10	MB10
	M 50 X 1,5	12	-	-	-	KM10	MB10
50	M 55 X 2	12,5	-	-	-	KM11	MB11
	M 55 X 2	12,5	-	-	-	KM11	MB11
	M 55 X 2	12,5	-	-	-	KM11	MB11



### Adapter sleeves

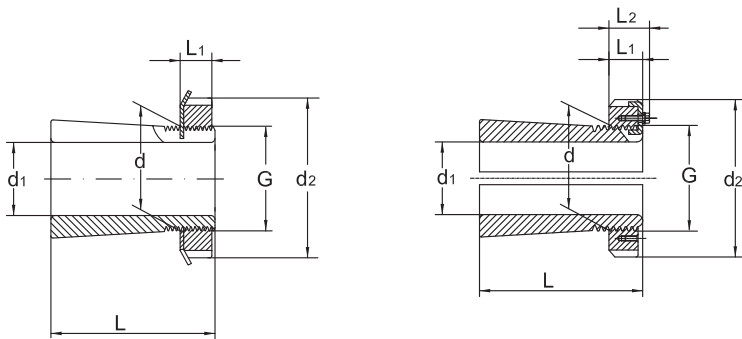

Shaft Ø	Dimension			Designation adapter sleeve, complete	Mass
	d <sub>1</sub>	d	d <sub>2</sub>		
mm					kg
55	60	80	38	H212	0,31
		80	47	H312	0,35
		80	62	H2312	0,45
60	65	85	40	H213	0,36
		85	50	H313	0,42
		85	65	H2313	0,52
	70	92	52	H314	0,68
		92	68	H2314	0,88
65	75	98	43	H215	0,66
		98	55	H315	0,78
		98	73	H2315	1,1
70	80	105	46	H216	0,81
		105	59	H316	0,95
		105	78	H2316	1,2
75	85	110	50	H217	0,94
		110	63	H317	1,1
		110	82	H2317	1,35
80	90	120	52	H218	1,1
		120	65	H318	1,3
		120	86	H2318	1,6
85	95	125	55	H219	1,25
		125	68	H319	1,4
		125	90	H2319	1,8
90	100	130	58	H220	1,4



## Adapter sleeves

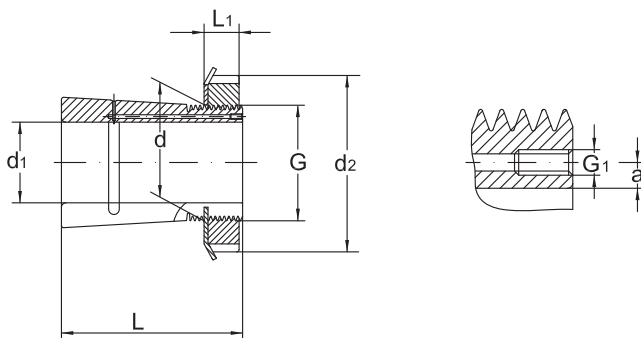

Shaft Ø	Thread	Dimensions				Lock nut	Locking Device
		d <sub>1</sub>	G	L <sub>1</sub>	L <sub>2</sub>		
mm							
55	M 60 X 2	13	-	-	-	KM12	MB 12
	M 60 X 2	13	-	-	-	KM12	MB12
	M 60 X 2	13	-	-	-	KM12	MB12
60	M 65 X 2	14	-	-	-	KM13	MB13
	M 65 X 2	14	-	-	-	KM13	MB13
	M 65 X 2	14	-	-	-	KM13	MB13
	M 70 X 2	14	-	-	-	KM14	MB14
	M 70 X 2	14	-	-	-	KM14	MB14
65	M 75 X 2	15	-	-	-	KM15	MB15
	M 75 X 2	15	-	-	-	KM15	MB15
	M 75 X 2	15	-	-	-	KM15	MB15
70	M 80 X 2	17	-	-	-	KM16	MB16
	M 80 X 2	17	-	-	-	KM16	MB16
	M 80 X 2	17	-	-	-	KM16	MB16
75	M 85 X 2	18	-	-	-	KM17	MB17
	M 85 X 2	18	-	-	-	KM17	MB17
	M 85 X 2	18	-	-	-	KM17	MB17
80	M 90 X 2	18	-	-	-	KM18	MB18
	M 90 X 2	18	-	-	-	KM18	MB18
	M 90 X 2	18	-	-	-	KM18	MB18
85	M 95 X 2	19	-	-	-	KM19	MB19
	M 95 X 2	19	-	-	-	KM19	MB19
	M 95 X 2	19	-	-	-	KM19	MB19
90	M 100 X 2	20	-	-	-	KM20	MB20



Adapter sleeves

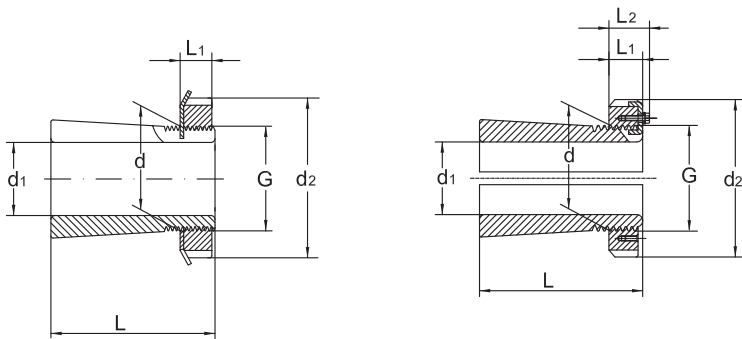

Shaft Ø	Dimension			Designation adapter sleeve, complete	Mass
	d <sub>1</sub>	d	d <sub>2</sub>		
mm					kg
90	100	130	71	<b>H320</b>	1,6
		130	97	<b>H2320</b>	2
		130	76	<b>H3120</b>	1,8
95	105	140	60	<b>H221</b>	1,6
		140	74	<b>H321</b>	1,85
100	110	145	63	<b>H222</b>	1,8
		145	77	<b>H322</b>	2,05
		145	105	<b>H2322</b>	2,75
		145	81	<b>H3122</b>	2,1
110	120	155	112	<b>H2324</b>	3
		145	72	<b>H3024</b>	1,8
		155	88	<b>H3124</b>	2,5
115	130	165	121	<b>H2326</b>	4,45
		155	80	<b>H3026</b>	2,8
		165	92	<b>H3126</b>	3,45
125	140	180	131	<b>H2328</b>	5,4
		165	82	<b>H3028</b>	3,05
		180	97	<b>H3128</b>	4,1
135	150	195	139	<b>H2330</b>	6,4
		180	87	<b>H3030</b>	3,75
		195	111	<b>H3130</b>	5,25
140	160	210	147	<b>H2332</b>	8,8
		210	147	<b>OH2332 H</b>	8,8
		190	93	<b>H3032</b>	5,1

## Adapter sleeves

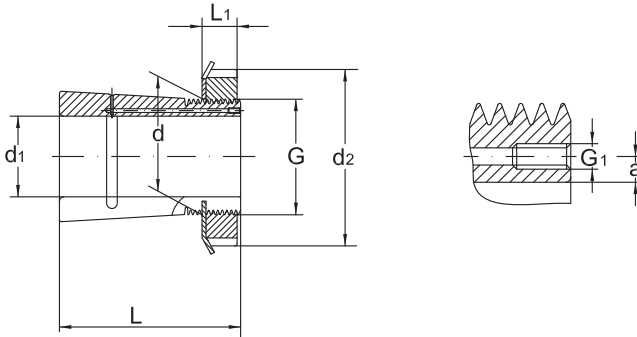

Shaft Ø	Thread	Dimensions				Lock nut	Locking Device
		d <sub>1</sub>	G	L <sub>1</sub>	L <sub>2</sub>		
mm							
90	M 100 X 2	20	-	-	-	KM20	MB20
	M 100 X 2	20	-	-	-	KM20	MB20
	M 100 X 2	20	-	-	-	KM20	MB20
95	M 105 X 2	20	-	-	-	KM21	MB21
	M 105 X 2	20	-	-	-	KM21	MB21
100	M 110 X 2	21	-	-	-	KM22	MB22
	M 110 X 2	21	-	-	-	KM22	MB22
	M 110 X 2	21	-	-	-	KM22	MB22
	M 110 X 2	31	-	-	-	KM22	MB22
110	M 120 X 2	22	-	-	-	KM24	MB24
	M 120 X 2	22	-	-	-	KML24	MBL24
	M 120 X 2	22	-	-	-	KM24	MB24
115	M 130 X 2	23	-	-	-	KM26	MB26
	M 130 X 2	23	-	-	-	KML26	MBL26
	M 130 X 2	23	-	-	-	KM26	MB26
125	M 140 X 2	24	-	-	-	KM28	MB28
	M 140 X 2	24	-	-	-	KML28	MBL28
	M 140 X 2	24	-	-	-	KM28	MB28
135	M 150 X 2	26	-	-	-	KM30	MB30
	M 150 X 2	26	-	-	-	KML30	MBL30
	M 150 X 2	26	-	-	-	KM30	MB30
140	M 160 X 3	28	-	-	-	KM32	MB32
	M 160 X 3	28	-	M 6	4,2	KM32	MB32
	M 160 X 3	27,5	-	-	-	KML32	MBL32



Adapter sleeves

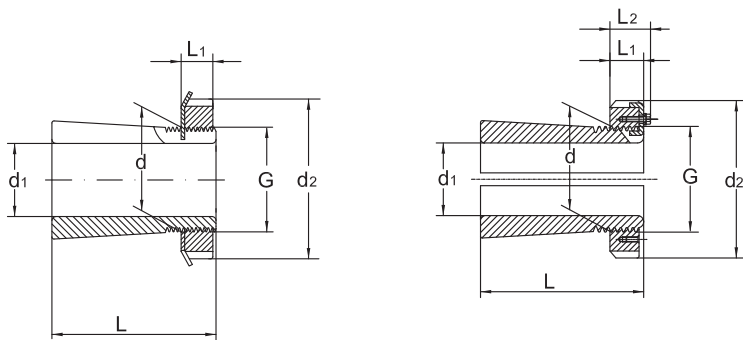

Shaft Ø	Dimension			Designation adapter sleeve, complete	Mass
d <sub>1</sub>	d	d <sub>2</sub>	L		
mm					kg
140	160	190	93	<b>OH3032 H</b>	5,1
		210	119	<b>H3132</b>	7,25
		210	119	<b>OH3132 H</b>	7,25
150	170	220	154	<b>H2334</b>	9,9
		220	154	<b>OH2334 H</b>	9,9
		200	101	<b>H3034</b>	5,8
		200	101	<b>OH3034 H</b>	5,8
		220	101	<b>H3134</b>	8,1
		220	101	<b>OH3134 H</b>	8,1
		220	122	<b>OH3134 H</b>	8,1
160	180	230	161	<b>H2336</b>	11
		230	161	<b>OH2336 H</b>	11
		210	109	<b>H3036</b>	6,7
		210	109	<b>OH3036 H</b>	6,7
		230	131	<b>H3136</b>	9,15
		230	131	<b>OH3136 H</b>	9,15
170	190	240	169	<b>H2338</b>	12
		240	169	<b>OH2338 H</b>	12
		220	112	<b>H3038</b>	7,25
		220	112	<b>OH3038 H</b>	7,25
		240	141	<b>H3138</b>	10,5
		240	141	<b>OH3138 H</b>	10,5
180	200	250	176	<b>H2340</b>	13,5
		250	176	<b>OH2340 H</b>	13,5
		240	120	<b>H3040</b>	8,9

## Adapter sleeves

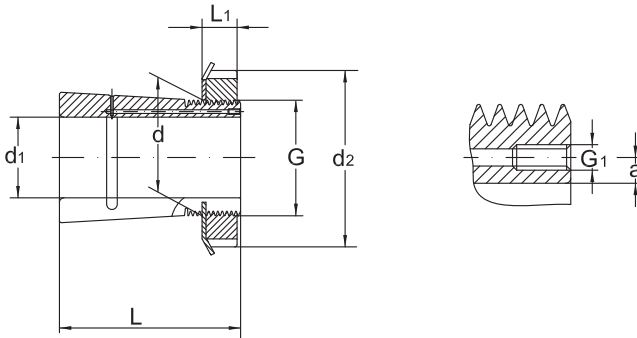

Shaft Ø	Thread	Dimensions				Lock nut	Locking Device
		$L_1$	$L_2$	G1	a		
$d_1$	G	mm					
140	M 160 X 3	27,5	-	M 6	4,2	KML32	MBL32
	M 160 X 3	28	-	-	-	KM32	MB32
	M 160 X 3	28	-	M 6	4,2	KM32	MB32
150	M 170 X 3	29	-	-	-	KM34	MB34
	M 170 X 3	29	-	M 6	4,2	KM34	MB34
	M 170 X 3	28,5	-	-	-	KML34	MBL34
	M 170 X 3	28,5	-	M 6	4,2	KML34	MBL34
	M 170 X 3	29	-	-	-	KM34	MB34
	M 170 X 3	29	-	M 6	4,2	KM34	MB34
	M 170 X 3	29	-	M 6	4,2	KM34	MB34
160	M 180 X 3	30	-	-	-	KM36	MB36
	M 180 X 3	30	-	M 6	4,2	KM36	MB36
	M 180 X 3	29,5	-	-	-	KML36	MBL36
	M 180 X 3	29,5	-	M 6	4,2	KML36	MBL36
	M 180 X 3	30	-	-	-	KM36	MB36
	M 180 X 3	30	-	M 6	4,2	KM36	MB36
170	M 190 X 3	31	-	-	-	KM38	MB38
	M 190 X 3	31	-	M 6	4,2	KM38	MB38
	M 190 X 3	30,5	-	-	-	KML38	MBL38
	M 190 X 3	30,5	-	M 6	4,2	KML38	MBL38
	M 190 X 3	31	-	-	-	KM38	MB38
	M 190 X 3	31	-	M 6	4,2	KM38	MB38
180	M 200 X 3	32	-	-	-	KM40	MB40
	M 200 X 3	32	-	M 6	4,2	KM40	MB40
	M 200 X 3	31,5	-	-	-	KML40	MBL40



### Adapter sleeves

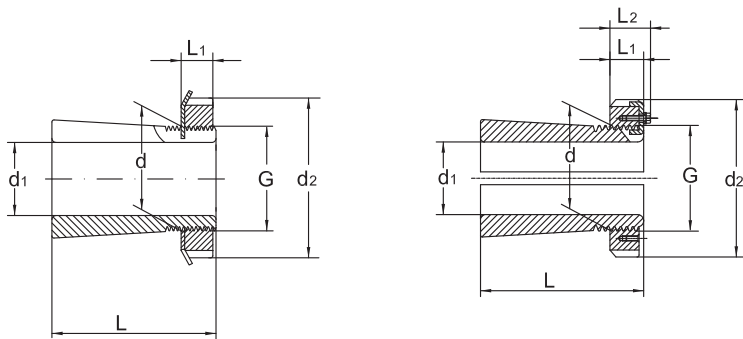

Shaft Ø	Dimension			Designation adapter sleeve, complete	Mass
	d <sub>1</sub>	d	d <sub>2</sub>		
mm					kg
180	200	240	120	<b>OH3040 H</b>	8,9
		250	150	<b>H3140</b>	12
		250	150	<b>OH3140H</b>	12
200	220	280	186	<b>H2344</b>	17
		280	186	<b>OH2344 H</b>	17
		260	126	<b>H3044</b>	9,9
		260	126	<b>OH3044 H</b>	9,9
		280	161	<b>H3144</b>	15
		280	161	<b>OH3144 H</b>	15
		280	161	<b>OH3144 H</b>	15
220	240	300	199	<b>H2348</b>	19
		300	199	<b>OH2348 H</b>	19
		290	133	<b>H3048</b>	12
		290	133	<b>OH3048 H</b>	12
		300	172	<b>H3148</b>	16
		300	172	<b>OH3148 H</b>	16
240	260	330	211	<b>H2352</b>	23
		330	211	<b>OH2352 H</b>	23
		310	145	<b>H3052</b>	13,5
		310	145	<b>OH3052 H</b>	13,5
		330	190	<b>H3152</b>	21
		330	190	<b>OH3152 H</b>	21
260	280	350	224	<b>H2356</b>	27
		350	224	<b>OH2356 H</b>	27
		330	152	<b>H3056</b>	16

## Adapter sleeves

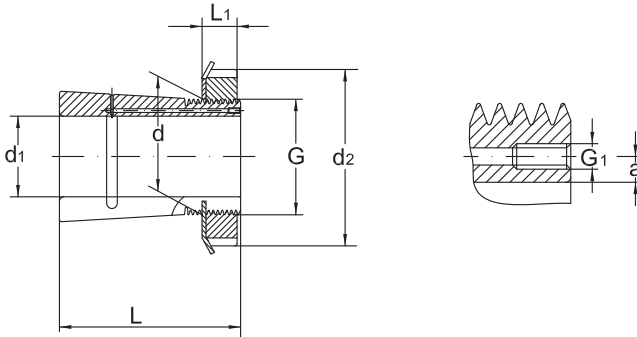

Shaft Ø	Thread	Dimensions				Lock nut	Locking Device
		d <sub>1</sub>	G	L <sub>1</sub>	L <sub>2</sub>		
mm							
180	M 200 X 3	31,5	-	M6	4,2	KML40	MBL40
	M 200 X 3	32	-	-	-	KM40	MB40
	M 200 X 3	32	-	M6	4,2	KM40	MB40
200	Tr 220 X 4	35	-	-	-	HM44 T	MB44
	Tr 220 X 4	35	-	M6	4,2	HM44 T	MB44
	Tr 220 X 4	30	41	-	-	HM3044	MS3044
	Tr 220 X 4	30	41	M6	4,2	HM3044	MS3044
	Tr 220 X 4	35	-	-	-	HM44 T	MB44
	Tr 220 X 4	35	-	M6	4,2	HM44 T	MB44
	Tr 220 X 4	35	-	-	-	HM44 T	MB44
220	Tr 240 X 4	37	-	-	-	HM48 T	MB48
	Tr 240 X 4	37	-	M6	4,2	HM48 T	MB48
	Tr 240 X 4	34	46	-	-	HM3048	MS3052-48
	Tr 240 X 4	34	46	M6	4,2	HM3048	MS3052-48
	Tr 240 X 4	37	-	-	-	HM48 T	MB48
	Tr 240 X 4	37	-	M6	4,2	HM48 T	MB48
240	Tr 260 X 4	39	-	-	-	HM52 T	MB52
	Tr 260 X 4	39	-	M6	4,2	HM52 T	MB52
	Tr 260 X 4	34	46	-	-	HM3052	MS3052-48
	Tr 260 X 4	34	46	M6	4,2	HM3052	MS3052-48
	Tr 260 X 4	39	-	-	-	HM52 T	MB52
	Tr 260 X 4	39	-	M6	4,2	HM52 T	MB52
260	Tr 280 X 4	41	-	-	-	HM56 T	MB56
	Tr 280 X 4	41	-	M6	4,2	HM56 T	MB56
	Tr 280 X 4	38	50	-	-	HM3056	MS3056



### Adapter sleeves

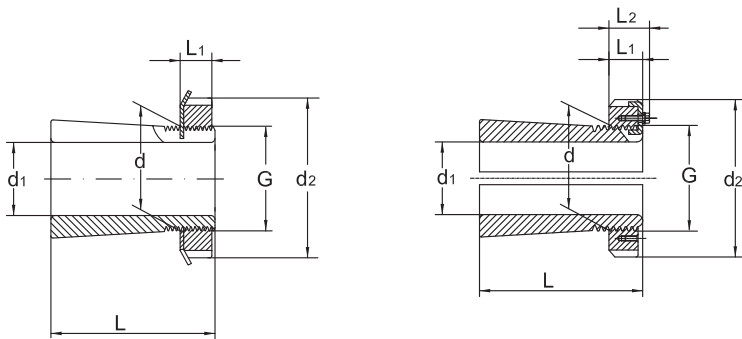

Shaft Ø	Dimension			Designation adapter sleeve, complete	Mass
	d <sub>1</sub>	d	d <sub>2</sub>		
mm					kg
260	280	330	152	<b>OH3056 H</b>	16
		350	195	<b>H3156</b>	23
		350	195	<b>OH3156 H</b>	23
280	300	360	168	<b>H3060</b>	20,5
		360	168	<b>OH3060 H</b>	20,5
		380	208	<b>H3160</b>	29
		380	208	<b>OH3160 H</b>	29
		380	240	<b>H3260</b>	32
		380	240	<b>OH3260 H</b>	32
		380	240	<b>OH3260 H</b>	32
300	320	380	171	<b>H3064</b>	22
		380	171	<b>OH3064 H</b>	22
		400	226	<b>H3164</b>	32
		400	226	<b>OH3164 H</b>	32
		400	258	<b>H3264</b>	35
		400	258	<b>OH3264 H</b>	35
320	340	400	187	<b>H3068</b>	27
		400	187	<b>OH3068 H</b>	27
		440	254	<b>H3168</b>	50
		440	254	<b>OH3168 H</b>	50
		440	288	<b>H3268</b>	51,5
		440	288	<b>OH3268 H</b>	51,5
340	360	420	188	<b>H3072</b>	29
		420	188	<b>OH3072 H</b>	29
		460	259	<b>H3172</b>	56



## Adapter sleeves

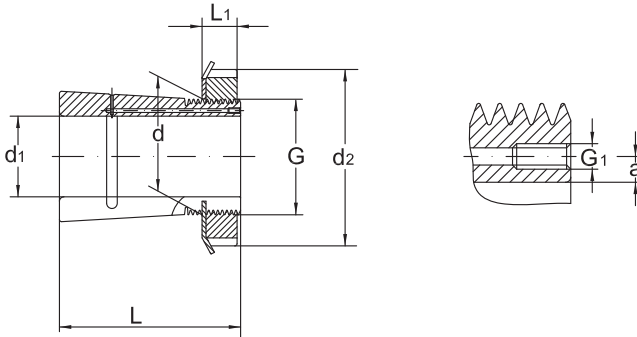

Shaft Ø	Thread	Dimensions				Lock nut	Locking Device
		d <sub>1</sub>	G	L <sub>1</sub>	L <sub>2</sub>		
mm							
<b>260</b>	Tr 280 X 4	38	50	M6	4,2	HM3056	MS3056
	Tr 280 X 4	41	-	-	-	HM56 T	MB56
	Tr 280 X 4	41	-	M6	4,2	HM56 T	MB56
<b>280</b>	Tr 300 X 4	42	54	-	-	HM3060	MS3060
	Tr 300 X 4	42	54	M6	4,2	HM3060	MS3060
	Tr 300 X 4	40	53	-	-	HM3160	MS3160
	Tr 300 X 4	40	53	M6	4,2	HM3460	MS3460
	Tr 300 X 4	40	53	-	-	HM3160	MS3160
	Tr 300 X 4	40	53	M6	4,2	HM3160	MS3160
	Tr 300 X 4	40	53	M6	4,2	HM3160	MS3160
<b>300</b>	Tr 320 X 5	42	55	-	-	HM3064	MS3068-64
	Tr 320 X 5	42	55	M6	4	HM3064	MS3068-64
	Tr 320 X 5	42	56	-	-	HM3164	MS3164
	Tr 320 X 5	42	56	M6	4	HM3164	MS3164
	Tr 320 X 5	42	56	-	-	HM3164	MS3164
	Tr 320 X 5	42	56	M6	4	HM3164	MS3164
<b>320</b>	Tr 340 X 5	45	58	-	-	HM3068	MS3068-64
	Tr 340 X 5	45	58	M6	4	HM3068	MS3068-64
	Tr 340 X 5	55	72	-	-	HM3168	MS3172-68
	Tr 340 X 5	55	72	M6	4	HM3168	MS3172-68
	Tr 340 X 5	55	72	-	-	HM3168	MS3172-68
	Tr 340 X 5	55	72	M6	4	HM3168	MS3172-68
<b>340</b>	Tr 360 X 5	45	58	-	-	HM3072	MS3072
	Tr 360 X 5	45	58	M6	4	HM3072	MS3072
	Tr 360 X 5	58	75	-	-	HM3172	MS3172-68



### Adapter sleeves

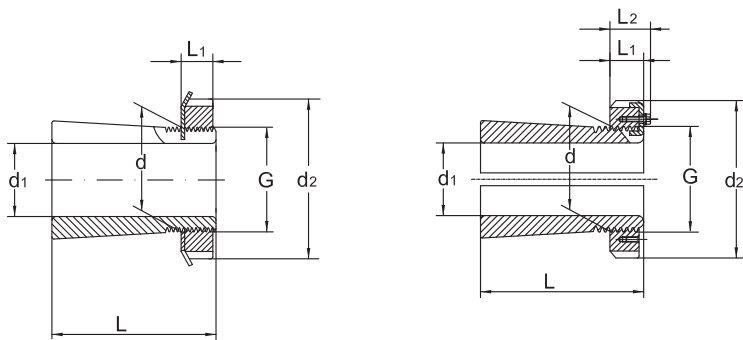

Shaft Ø	Dimension			Designation adapter sleeve, complete	Mass
	d <sub>1</sub>	d	d <sub>2</sub>		
mm					kg
340	360	460	259	<b>OH3172 H</b>	56
		460	299	<b>H3272</b>	60,5
		460	299	<b>OH3272 H</b>	60,5
360	380	450	193	<b>H3076</b>	35,5
		450	193	<b>OH3076 H</b>	35,5
		490	264	<b>H3176</b>	61,5
		490	264	<b>OH3176 H</b>	61,5
		490	310	<b>H3276</b>	69,5
		490	310	<b>OH3276 H</b>	69,5
380	400	470	210	<b>H3080</b>	40
		470	210	<b>OH3080 H</b>	40
		520	272	<b>H3180</b>	73
		520	272	<b>OH3180 H</b>	73
400	420	490	212	<b>H3084</b>	47
		490	212	<b>OH3084 H</b>	47
		540	304	<b>H3184</b>	80
		540	304	<b>OH3184 H</b>	80
410	440	520	228	<b>H3088</b>	65
		520	228	<b>OH3088 H</b>	65
		560	307	<b>H3188</b>	95
		560	307	<b>OH3188 H</b>	95
430	460	540	234	<b>H3092</b>	71
		540	234	<b>OH3092 H</b>	71
		580	326	<b>H3192</b>	119

## Adapter sleeves

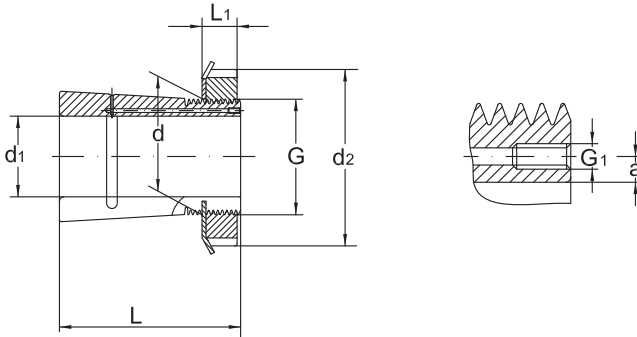

Shaft Ø	Thread	Dimensions				Lock nut	Locking Device
		d <sub>1</sub>	G	L <sub>1</sub>	L <sub>2</sub>		
mm							
340	Tr 360 X 5	58	75	M6	4	HM3172	MS3172-68
	Tr 360 X 5	58	75	-	-	HM3172	MS3172-68
	Tr 360 X 5	58	75	-	10	HM3172	MS3172-68
360	Tr 380 X 5	48	62	-	-	HM3076	MS3080-76
	Tr 380 X 5	48	62	M6	4	HM3076	MS3080-76
	Tr 380 X 5	60	77	-	-	HM3176	MS3176
	Tr 380 X 5	60	77	M6	4	HM3176	MS3176
	Tr 380 X 5	60	77	-	-	HM3176	MS3176
	Tr 380 X 5	60	77	-	-	HM3176	MS3176
	Tr 380 X 5	60	77	-	10,5	HM3176	MS3176
380	Tr 400 X 5	52	66	-	-	HM3080	MS3080-76
	Tr 400 X 5	52	66	M6	4	HM3080	MS3080-76
	Tr 400 X 5	62	82	-	-	HM3180	MS3184-80
	Tr 400 X 5	62	82	M6	4	HM3180	MS3184-80
400	Tr 420 X 5	52	66	-	-	HM3084	MS3084
	Tr 420 X 5	52	66	M6	4	HM3084	MS3084
	Tr 420 X 5	70	90	-	-	HM3184	MS3184-80
	Tr 420 X 5	70	90	M6	4	HM3184	MS3184-80
410	Tr 440 X 5	60	77	-	-	HM3088	MS3092-88
	Tr 440 X 5	60	77	M8	6,5	HM3088	MS3092-88
	Tr 440 X 5	70	90	-	-	HM3188	MS3192-88
	Tr 440 X 5	70	90	M8	6,5	HM3188	MS3192-88
430	Tr 460 X 5	60	77	-	-	HM3092	MS3092-88
	Tr 460 X 5	60	77	M8	6,5	HM3092	MS3092-88
	Tr 460 X 5	75	95	-	-	HM3192	MS3192-88



### Adapter sleeves

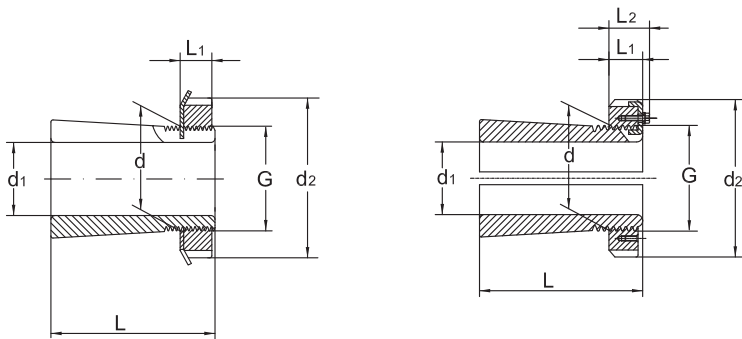

Shaft Ø	Dimension			Designation adapter sleeve, complete	Mass
	d <sub>1</sub>	d	d <sub>2</sub>		
mm					kg
<b>430</b>	460	580	326	<b>OH3192 H</b>	119
<b>450</b>	480	560	237	<b>H3096</b>	75
		560	237	<b>OH3096 H</b>	75
		620	335	<b>H3196</b>	135
		620	335	<b>OH3196 H</b>	135
<b>470</b>	500	580	247	<b>H30/500</b>	82
		580	247	<b>OH30/500 H</b>	82
		630	356	<b>H31/500</b>	145
		630	356	<b>OH31/500 H</b>	145
<b>500</b>	530	630	265	<b>H30/530</b>	105
		630	265	<b>OH30/530 H</b>	105
<b>530</b>	560	650	282	<b>H30/560</b>	112
		650	282	<b>OH30/560 H</b>	112
<b>560</b>	600	700	289	<b>H30/600</b>	147
		700	289	<b>OH30/600 H</b>	147
<b>600</b>	630	730	301	<b>H30/630</b>	138
		730	301	<b>OH30/630 H</b>	138
<b>630</b>	670	780	324	<b>H30/670</b>	190
		780	324	<b>OH30/670 H</b>	190
<b>670</b>	710	830	342	<b>H30/710</b>	228
		830	342	<b>OH30/710 H</b>	228
<b>710</b>	750	870	356	<b>H30/750</b>	246
		870	356	<b>OH30/750 H</b>	246
<b>750</b>	800	920	366	<b>H30/800</b>	302

## Adapter sleeves

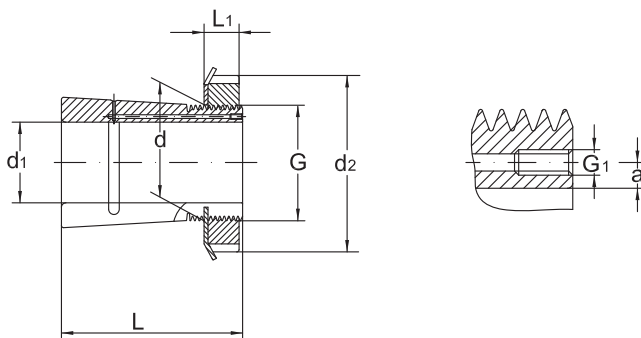

Shaft Ø	Thread	Dimensions				Lock nut	Locking Device
		$L_1$	$L_2$	G1	a		
$d_1$	G	mm					
430	Tr 460 X 5	75	95	M8	6,5	HM3192	MS3192-88
450	Tr 480 X 5	60	77	-	-	HM3096	MS30/500-96
	Tr 480 X 5	60	77	M8	6,5	HM3096	MS30/500-96
	Tr 480 X 5	75	95	-	-	HM3196	MS3196
	Tr 480 X 5	75	95	M8	6,5	HM3196	MS3196
470	Tr 500 X 5	68	85	-	-	HM30/500	MS30/500-96
	Tr 500 X 5	68	85	M8	6,5	HM30/500	MS30/500-96
	Tr 500 X 5	80	100	-	-	HM31/500	MS31/500
	Tr 500 X 5	80	100	M8	6,5	HM31/500	MS31/500
500	Tr 530 X 6	68	90	-	-	HM30/530	MS30/600-530
	Tr 530 X 6	68	90	M8	6	HM30/530	MS30/600-530
530	Tr 560 X 6	75	97	-	-	HM30/560	MS30/560
	Tr 560 X 6	75	97	M8	6	HM30/560	MS30/560
560	Tr 600 X 6	75	97	-	-	HM30/600	MS30/600-530
	Tr 600 X 6	75	97	-	8	HM30/600	MS30/600-530
600	Tr 630 X 6	75	97	-	-	HM30/630	MS30/630
	Tr 630 X 6	75	97	M8	6	HM30/630	MS30/630
630	Tr 670 X 6	80	102	-	-	HM30/670	MS30/670
	Tr 670 X 6	80	102	-	8	HM30/670	MS30/670
670	Tr 710 X 7	90	112	-	-	HM30/710	MS30/710
	Tr 710 X 7	90	112	-	8	HM30/710	MS30/710
710	Tr 750 X 7	90	112	-	-	HM30/750	MS30/800-750
	Tr 750 X 7	90	112	-	8	HM30/750	MS30/800-750
750	Tr 840 X 7	90	112	-	-	HM30/800	MS30/800-750



Adapter sleeves

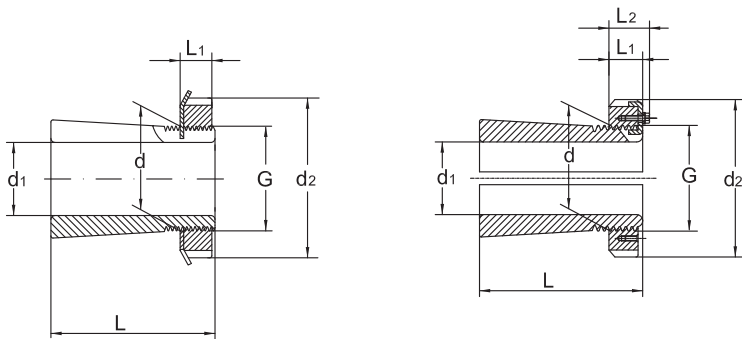

Shaft Ø	Dimension			Designation adapter sleeve, complete	Mass
	d <sub>1</sub>	d	d <sub>2</sub>		
	mm				kg
<b>750</b>	800	920	366	<b>OH30/800 H</b>	302
<b>800</b>	850	980	380	<b>H30/850</b>	341
		980	380	<b>OH30/850 H</b>	341

## Adapter sleeves

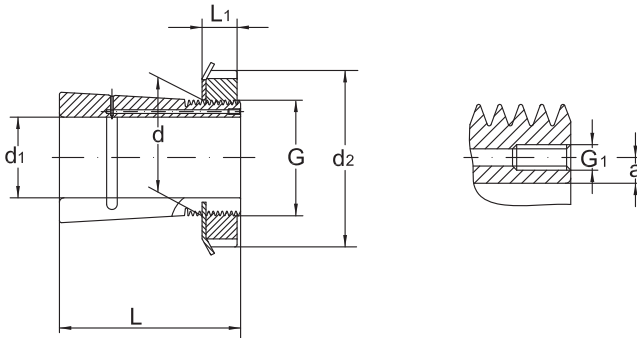

Shaft Ø	Thread	Dimensions				Lock nut	Locking Device
		L <sub>1</sub>	L <sub>2</sub>	G1	a		
d <sub>1</sub>	G	mm					
<b>750</b>	Tr 800 X 7	90	112	-	10	HM30/800	MS30/800-750
<b>800</b>	Tr 850 X 7	90	115	-	-	HM30/850	MS30/900-850
	Tr 850 X 7	90	115	-	10	HM30/850	MS30/900-850

## Withdrawal Sleeves

### Standards, Boundary dimensions

Withdrawal Sleeves                      DIN 5416

### General

**Withdrawal sleeves** (see sketch below) are slotted steel sleeves that have a tapered outer diameter on one side and a thread on the large diameter on the opposite side.

Standard withdrawal sleeves have tapered outers, taper **1:12** except for withdrawal sleeves of series **AH 240** and **AH 241** having tapers **1:30**.

**URB Withdrawal Sleeves** are supplied without lock nut as standard.

**URB Withdrawal Sleeves** are produced in two different designs as standard.

Beside the standard design (see figure **a**), larger withdrawal sleeves from bore diameter 200 mm onwards are also available with oil bores and oil distribution ducts as required for applying the oil injection method as shown in figure **b**.

**URB withdrawal sleeves** that are foreseen with facilities for an application of the oil injection method are designated "**AOH...**"

When withdrawal sleeves are used, the bearing inner ring must to be supported by an effective surface contact, such as a shaft shoulder, (see figure **a**).

Where larger radii bearing journals and shaft shoulders are necessary for strength reasons, (e.g. where such radii become larger than the bearing fillet, suitable distance rings must be applied.)

In each case the withdrawal sleeves must be secured against axial displacement loosening by means of lock nuts (see fig. c) or end plates (fig. d).

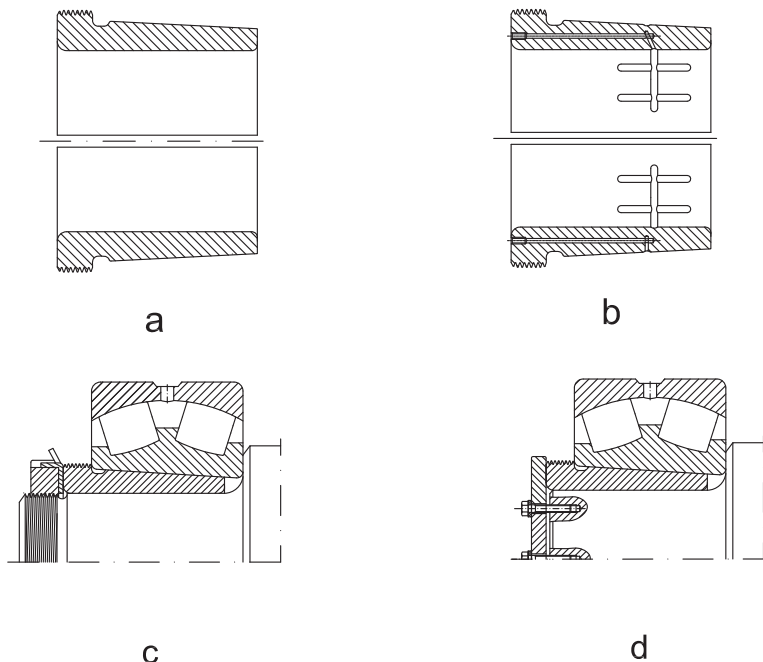



## Withdrawal Sleeves

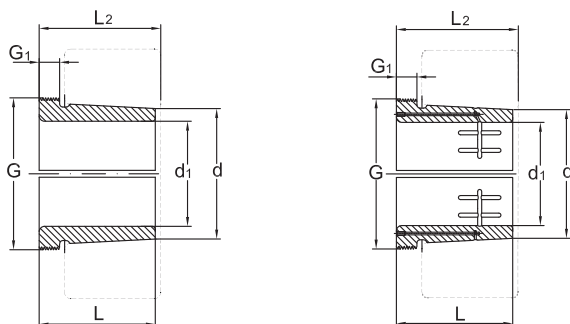

Shaft Ø	Dimension						Designation adapter sleeve, complete	Mass kg	Lock Nut
	d <sub>1</sub>	d	G	G <sub>1</sub>	G <sub>2</sub>	L			
		mm							
35	40	M 45 X 1,5	6	-	29	32	AH308	0,09	KM 9
		M 45 X 1,5	7	-	40	43	AH2308	0,13	KM 9
40	45	M 50 X 1,5	6	-	31	34	AH309	0,12	KM 10
		M 50 X 1,5	7	-	44	47	AH2309	0,16	KM 10
45	50	M 55 X 2	7	-	35	38	AHX310	0,13	KM 11
		M 55 X 2	9	-	50	53	AHX2310	0,19	KM 11
50	55	M 60 X 2	7	-	37	40	AHX311	0,16	KM 12
		M 60 X 2	10	-	54	57	AHX2311	0,26	KM 12
55	60	M 65 X 2	8	-	40	43	AHX312	0,19	KM 13
		M 65 X 2	11	-	58	61	AHX2312	0,30	KM 13
60	65	M 70 X 2	8	-	42	45	AH313 G	0,22	KM 14
		M 75 X 2	12	-	61	64	AH2313	0,39	KM 15
65	70	M 75 X 2	8	-	43	47	AH314 G	0,24	KM 15
		M 80 X 2	12	-	64	68	AHX2314	0,45	KM 16
70	75	M 80 X 2	8	-	45	49	AH315 G	0,29	KM 16
		M 85 X 2	12	-	68	72	AHX2315	0,53	KM 17



### Withdrawal Sleeves

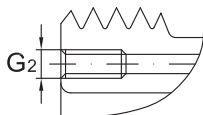

Shaft Ø	Dimension						Designation adapter sleeve, complete	Mass kg	Lock Nut
	d <sub>1</sub>	d	G	G <sub>1</sub>	G <sub>2</sub>	L			
mm									
75	80	M 90 X 2	8	-	48	52	AH316	0,37	KM 18
		M 90 X 2	12	-	71	75	AHX2316	0,57	KM 18
80	85	M 95 X 2	9	-	52	56	AH317	0,43	KM 19
		M 95 X 2	13	-	74	78	AHX2317	0,65	KM 19
85	90	M 100 X 2	9	-	53	57	AH318	0,46	KM 20
		M 100 X 2	10	-	63	67	AHX3218	0,57	KM 20
		M 100 X 2	14	-	79	83	AHX2318	0,76	KM 20
90	95	M 105 X 2	10	-	57	61	AH319	0,54	KM 21
		M 105 X 2	16	-	57	61	AHX2319	0,90	KM 21
95	100	M 110 X 2	10	-	59	63	AH320	0,58	KM 22
		M 110 X 2	11	-	64	68	AHX3120	0,66	KM 22
		M 110 X 2	11	-	73	77	AHX3220	0,76	KM 22
		M 110 X 2	16	-	90	94	AHX2320	1,00	KM 22
105	110	M 120 X 2	11	-	68	72	AH3122	0,76	KM 24
		M 125 X 2	11	-	82	86	AHX3222	1,05	KM 25
		M 125 X 2	16	-	98	102	AHX2322	1,35	KM 25

## Withdrawal Sleeves

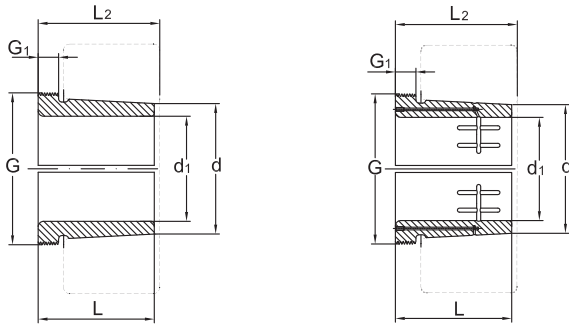

Shaft Ø	Dimension						Designation adapter sleeve, complete	Mass kg	Lock Nut
	d <sub>1</sub>	d	G	G <sub>1</sub>	G <sub>2</sub>	L			
mm									
<b>105</b>	110	M 115 X 2	13	-	82	91	<b>AH24122</b>	0,71	KM 23
<b>115</b>	120	M 130 X 2	13	-	60	64	<b>AHX3024</b>	0,73	KM 26
		M 130 X 2	12	-	75	79	<b>AHX3124</b>	0,94	KM 26
		M 135 X 2	13	-	90	94	<b>AHX3224</b>	1,30	KM 27
		M 135 X 2	17	-	105	109	<b>AHX2324</b>	1,65	KM 27
		M 125 X 2	13	-	73	82	<b>AH24024</b>	0,70	KM 25
		M 130 X 2	13	-	93	102	<b>AH24124</b>	1,00	KM 26
<b>125</b>	130	M 140 X 2	14	-	67	71	<b>AHX3026</b>	0,91	KM 28
		M 140 X 2	12	-	78	82	<b>AHX3126</b>	1,10	KM 28
		M 145 X 2	15	-	98	102	<b>AHX3226</b>	1,55	KM 29
		M 145 X 2	19	-	115	119	<b>AHX2326</b>	2,00	KM 29
		M 135 X 2	14	-	83	93	<b>AH24026</b>	0,88	KM 27
		M 140 X 2	14	-	94	104	<b>AH24126</b>	1,15	KM 28
<b>135</b>	140	M 150 X 2	14	-	68	73	<b>AHX3028</b>	1,00	KM 30
		M 150 X 2	14	-	83	88	<b>AHX3128</b>	1,30	KM 30
		M 155 X 3	15	-	104	109	<b>AHX3228</b>	1,85	KM 31



### Withdrawal Sleeves

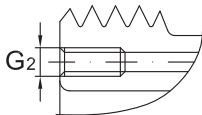

Shaft Ø	Dimension						Designation adapter sleeve, complete	Mass kg	Lock Nut
	d <sub>1</sub>	d	G	G <sub>1</sub>	G <sub>2</sub>	L			
mm									
135	140	M 155 X 3	20	-	125	130	AHX2328	2,35	KM 31
		M 145 X 2	14	-	83	93	AH24028	0,95	KM 29
		M 150 X 2	14	-	99	109	AH24128	1,30	KM 30
145	150	M 160 X 3	15	-	72	77	AHX3030	1,15	KM 32
		M 165 X 3	15	-	96	101	AHX3130	1,80	KM 33
		M 165 X 3	17	-	114	119	AHX3230	2,20	KM 33
		M 165 X 3	24	-	135	140	AHX2330	2,80	KM 33
		M 155 X 3	15	-	90	101	AH24030	1,05	KM 31
		M 160 X 3	15	-	115	126	AH24130	1,55	KM 32
150	160	M 170 X 3	16	-	77	82	AH3032	2,05	KM 34
		M 180 X 3	16	-	103	108	AH3132	3,20	KM 36
		M 180 X 3	20	-	124	130	AH3232	4,00	KM 36
		M 180 X 3	24	-	140	146	AH2332	4,65	KM 36
		M 170 X 3	15	-	95	106	AH24032	2,30	KM 34
		M 170 X 3	15	-	124	135	AH24132	3,05	KM 34
160	170	M 180 X 3	17	-	85	90	AH3034	2,40	KM 36

## Withdrawal Sleeves

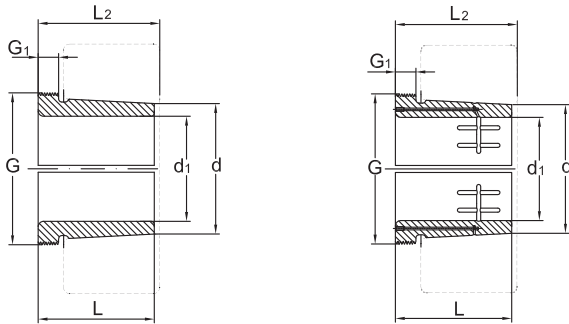

Shaft Ø	Dimension						Designation adapter sleeve, complete	Mass kg	Lock Nut
	d <sub>1</sub>	d	G	G <sub>1</sub>	G <sub>2</sub>	L			
mm									
160	170	M 190 X 3	16	-	104	109	AH3134	3,45	KM 38
		M 190 X 3	24	-	134	140	AH3234	4,80	KM 38
		M 190 X 3	24	-	146	152	AH2334	5,25	KM 38
		M 180 X 3	16	-	106	117	AH24034	2,70	KM 36
		M 180 X 3	16	-	125	136	AH24134	3,25	KM 36
170	180	M 190 X 3	17	-	92	98	AH3036	2,80	KM 38
		M 200 X 3	17	-	105	110	AH2236	3,75	KM 40
		M 200 X 3	19	-	116	122	AH3136	4,25	KM 40
		M 200 X 3	24	-	140	146	AH3236	5,25	KM 40
		M 200 X 3	26	-	154	160	AH2336	6,05	KM 40
		M 190 X 3	16	-	116	127	AH24036	3,20	KM 38
		M 190 X 3	16	-	134	145	AH24136	3,75	KM 38
180	190	Tr 205 X 4	18	-	96	102	AH3238	3,40	HML 41 T
		Tr 210 X 4	18	-	112	117	AH2238	4,25	HM 42 T
		Tr 210 X 4	20	-	125	131	AH3138	4,90	HM 42 T
		Tr 210 X 4	25	-	145	152	AH3238	5,90	HM 42 T



## Withdrawal Sleeves

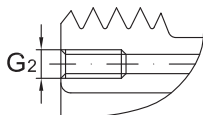

Shaft Ø	Dimension						Designation adapter sleeve, complete	Mass kg	Lock Nut
	d <sub>1</sub>	d	G	G <sub>1</sub>	G <sub>2</sub>	L			
		mm							
180	190	Tr 210 X 4	26	-	160	167	AH2338	6,70	HM 42 T
		M 200 X 3	18	-	118	131	AH24038	3,55	KM 40
		M 200 X 3	18	-	146	159	AH24138	4,45	KM 40
190	200	Tr 215 X 4	19	-	102	108	AH3040	3,85	HML 43 T
		Tr 220 X 4	19	-	118	123	AH2240	4,70	HM 44 T
		Tr 220 X 4	21	-	134	140	AH3140	5,65	HM 44 T
		Tr 220 X 4	25	-	153	160	AH3240	6,60	HM 44 T
		Tr 220 X 4	30	-	170	177	AH2340	7,60	HM 44 T
		Tr 210 X 4	18	-	127	140	AH24040	4,00	HM 42 T
		Tr 210 X 4	18	-	158	171	AH24140	5,05	HM 42 T
200	220	Tr 235 X 4	20	G 1/8	111	117	AH3044	7,40	HML 47 T
		Tr 240 X 4	23	G 1/4	145	115	AH3144	9,30	HM 48 T
		Tr 240 X 4	30	G 1/4	181	189	AH2344	13,5	HM 48 T
		Tr 230 X 4	20	G 1/8	138	152	AH24044	8,20	HM 46 T
		Tr 230 X 4	20	G 1/8	170	184	AH24144	10,0	HM 46 T
220	240	Tr 260 X 4	21	G 1/4	116	123	AH3048	7,95	HM 3052

## Withdrawal Sleeves

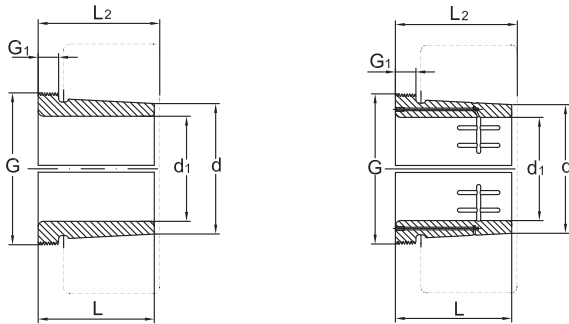

Shaft Ø	Dimension						Designation adapter sleeve, complete	Mass kg	Lock Nut
	d <sub>1</sub>	d	G	G <sub>1</sub>	G <sub>2</sub>	L			
mm									
<b>220</b>	240	Tr 260 X 4	25	G 1/4	154	161	<b>AH3148</b>	12,0	HM 52 T
		Tr 260 X 4	30	G 1/4	189	197	<b>AH2348</b>	14,0	HM 52 T
		Tr 250 X 4	20	G 1/8	138	153	<b>A0H24048</b>	8,05	HM 50 T
		Tr 260 X 4	20	G 1/4	180	195	<b>A0H24148</b>	11,5	HM 52 T
<b>240</b>	260	Tr 280 X 4	23	G 1/4	128	135	<b>A0H3052</b>	9,60	HM 3056
		Tr 290 X 4	23	G 1/4	155	161	<b>A0H2252</b>	12,5	HM 58 T
		Tr 290 X 4	26	G 1/4	172	179	<b>A0H3152</b>	16,0	HM 58 T
		Tr 290 X 4	30	G 1/4	205	213	<b>A0H2352</b>	17,5	HM 58 T
		Tr 270 X 4	22	G 1/8	162	178	<b>A0H24052</b>	10,5	HM 54 T
		Tr 280 X 4	22	G 1/4	202	218	<b>A0H24152</b>	14,0	HM 56 T
<b>260</b>	280	Tr 300 X 4	24	G 1/4	131	139	<b>A0H3056</b>	11,0	HM 3060
		Tr 310 X 5	28	G 1/4	175	183	<b>A0H3156</b>	15,5	HM 62 T
		Tr 310 X 5	30	G 1/4	212	220	<b>A0H2356</b>	19,5	HM 62 T
		Tr 290 X 4	22	G 1/8	162	179	<b>A0H24056</b>	11,5	HM 58 T
		Tr 300 X 4	22	G 1/4	202	219	<b>A0H24156</b>	15,0	HM 3160
<b>280</b>	300	Tr 320 X 5	26	G 1/4	145	153	<b>A0H3060</b>	13,0	HM 3064



### Withdrawal Sleeves

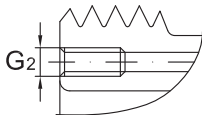

Shaft Ø	Dimension						Designation adapter sleeve, complete	Mass kg	Lock Nut
	d <sub>1</sub>	d	G	G <sub>1</sub>	G <sub>2</sub>	L			
		mm							
280	300	Tr 330 X 5	30	G 1/4	192	200	<b>A0H3160</b>	19,0	HM 66 T
		Tr 330 X 5	34	G 1/4	228	236	<b>A0H3260</b>	23,5	HM 66 T
		Tr 310 X 5	24	G 1/8	184	202	<b>A0H24060</b>	14,0	HM 62 T
		Tr 320 X 5	24	G 1/4	224	242	<b>A0H24160</b>	18,5	HM 3164
300	320	Tr 345 X 5	27	G 1/4	149	157	<b>A0H3064</b>	14,5	HM 69 T
		Tr 350 X 5	31	G 1/4	209	217	<b>A0H3164</b>	22,5	HM 70 T
		Tr 350 X 5	36	G 1/4	246	254	<b>A0H3264</b>	27,5	HM 70 T
		Tr 330 X 5	24	G 1/8	184	202	<b>A0H24064</b>	15,0	HM 66 T
		Tr 340 X 5	24	G 1/4	242	260	<b>A0H24164</b>	20,5	HM 3168
320	340	Tr 365 X 5	28	G 1/4	162	171	<b>A0H3068</b>	17,5	HML 73 T
		Tr 370 X 5	33	G 1/4	225	234	<b>A0H3168</b>	26,5	HM 74 T
		Tr 370 X 5	38	G 1/4	264	273	<b>A0H3268</b>	32,0	HM 74 T
		Tr 360 X 5	26	G 1/4	206	225	<b>A0H24068</b>	18,0	HM 3072
		Tr 360 X 5	26	G 1/4	269	288	<b>A0H24168</b>	25,5	HM 3172
340	360	Tr 385 X 5	30	G 1/4	167	176	<b>A0H3072</b>	19,0	HML 77 T
		Tr 400 X 5	35	G 1/4	229	238	<b>A0H3172</b>	30,0	HM 3180



## Withdrawal Sleeves

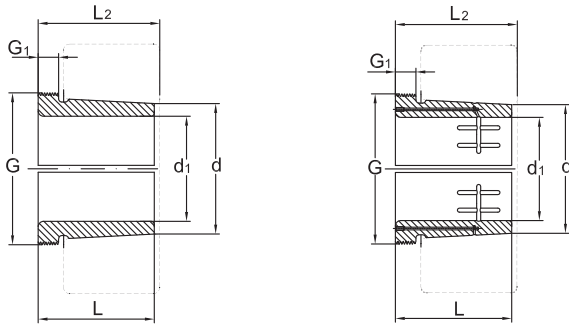

Shaft Ø	Dimension						Designation adapter sleeve, complete	Mass kg	Lock Nut
	d <sub>1</sub>	d	G	G <sub>1</sub>	G <sub>2</sub>	L			
mm									
<b>340</b>	360	Tr 400 X 5	40	G 1/4	274	283	<b>A0H3272</b>	33,0	HM 3180
		Tr 380 X 5	26	G 1/4	206	226	<b>A0H24072</b>	20,0	HM 3076
		Tr 380 X 5	26	G 1/4	269	289	<b>A0H24172</b>	26,0	HM 3176
<b>360</b>	380	Tr 410 X 5	31	G 1/4	170	180	<b>A0H3076</b>	23,5	HML 82 T
		Tr 420 X 5	36	G 1/4	232	242	<b>A0H3176</b>	38,0	HM 3184
		Tr 420 X 5	42	G 1/4	284	294	<b>A0H3276</b>	45,5	HM 3184
		Tr 400 X 5	28	G 1/4	208	228	<b>A0H24076</b>	23,5	HM 3080
		Tr 400 X 5	28	G 1/4	271	291	<b>A0H24176</b>	31,0	HM 3180
<b>380</b>	400	Tr 430 X 5	33	G 1/4	183	193	<b>A0H3080</b>	27,0	HML 86 T
		Tr 440 X 5	38	G 1/4	240	250	<b>A0H3180</b>	39,5	HM 3188
		Tr 440 X 5	44	G 1/4	302	312	<b>A0H3280</b>	51,5	HM 3188
		Tr 420 X 5	28	G 1/4	228	248	<b>A0H24080</b>	27,0	HM 3084
		Tr 420 X 5	28	G 1/4	278	298	<b>A0H24180</b>	35,0	HM 3184
<b>400</b>	420	Tr 450 X 5	34	G 1/4	186	196	<b>A0H3084</b>	29,0	HML 90 T
		Tr 460 X 5	40	G 1/4	266	276	<b>A0H3184</b>	46,0	HM 3192
		Tr 440 X 5	30	G 1/4	230	252	<b>A0H24084</b>	29,0	HM 3088



### Withdrawal Sleeves

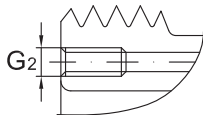

Shaft Ø	Dimension						Designation adapter sleeve, complete	Mass kg	Lock Nut
	d <sub>1</sub>	d	G	G <sub>1</sub>	G <sub>2</sub>	L			
	mm								
<b>400</b>	420	Tr 440 X 5	30	G 1/4	310	332	<b>AOH24184</b>	39,0	HM 3188
<b>420</b>	440	Tr 460 X 5	30	G 1/4	242	264	<b>AOH24088</b>	32,0	HML 92 T
		Tr 460 X 5	30	G 1/4	310	332	<b>AOH24188</b>	45,5	HM 3192
<b>440</b>	460	Tr 480 X 5	32	G 1/4	332	355	<b>AOH24192</b>	50,0	HM 3196
<b>460</b>	480	Tr 500 X 5	32	G 1/4	340	363	<b>AOH24196</b>	51,5	HM 31/500
<b>480</b>	500	Tr 530 X 6	35	G 1/4	360	383	<b>AOH241/500</b>	57,0	HM 31/530
<b>500</b>	530	Tr 550 X 6	35	G 1/4	370	394	<b>AOH241/530</b>	86,0	HM 110 T
<b>530</b>	560	Tr 580 X 6	38	G 1/4	393	417	<b>AOH241/560</b>	97,0	HM 116 T
<b>560</b>	600	Tr 630 X 6	38	G 1/4	413	439	<b>AOH241/600</b>	120	HM 126 T
<b>600</b>	630	Tr 650 X 6	40	G 1/4	440	466	<b>AOH241/630</b>	130	HM 130 T

# URB



## NOTES

